

XS WIRELESS 1

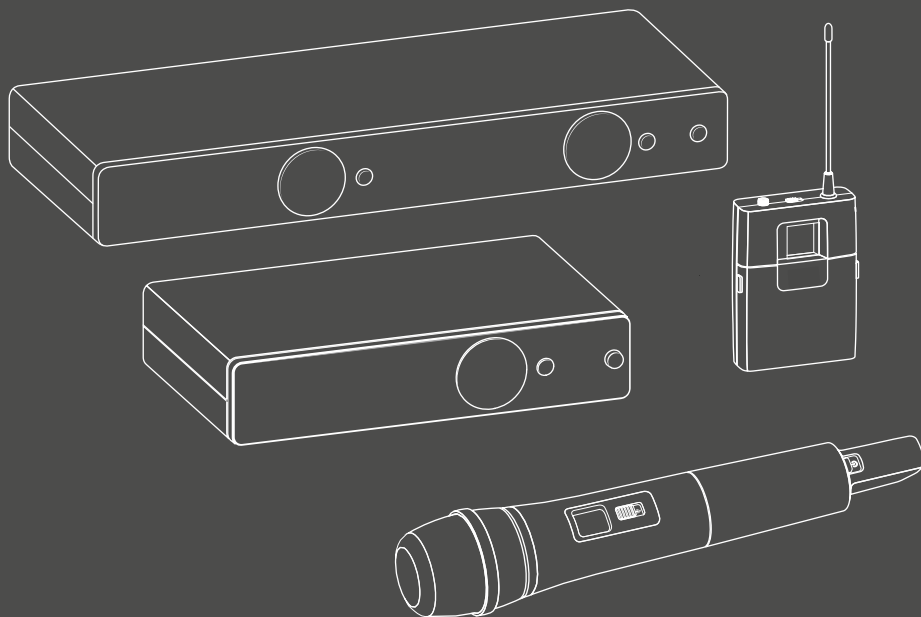

Technische Daten
Specifications
Caractéristiques techniques
Dati tecnici
Especificaciones técnicas
Dados técnicos
Technische specificaties
Dane techniczne

Tekniska data
Tekniske data
Tekniset tiedot
Τεχνικά χαρακτηριστικά
Технические характеристики
技术参数
기술 데이터

Technische Daten

System

Modulationsart	Breitband-FM
Frequenzbereiche	A: 548 bis 572 MHz GB: 606 bis 630 MHz B: 614 bis 638 MHz BC: 670 bis 694 MHz C: 766 bis 790 MHz D: 794 bis 806 MHz E: 821 bis 832 MHz und 863 bis 865 MHz K: 925 bis 937,5 MHz
Schaltbandbreite	Bis zu 24 MHz
Frequenzen	8 Kanalbänke mit jeweils bis zu 10 voreingestellten Kanälen
Signal-Rausch-Abstand	≥ 103 dBA
Klirrfaktor	≤ 0,9 %
Temperaturbereich	im Betrieb: 0 °C bis +40 °C Lagerung: -20 °C bis +70 °C
Sender-Synchronisation	2,4 GHz, RF Power <3 mW, Low Power OQPSK (nur während Synchronisation aktiv)

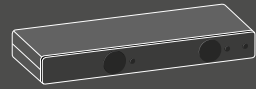

Empfänger

	EM-XSW1	EM-XSW1 DUAL
Empfängerprinzip	Double-Superheterodyn	
Diversity Prinzip	Antenna Switching Diversity über interne Antennen	
Empfindlichkeit (bei Spitzenhub)	< 3 µV bei 52 dB(A) _{eff} S/N	
Audio-Übertragungsbereich	50 bis 16 000 Hz (-3 dB)	
max. Audio-Ausgangsspannung (bei Spitzenhub, 1 kHz NF)	6,3-mm-Klinkenbuchse (unsymmetrisch): +6 dBu XLR-Buchse (symmetrisch): +12 dBu	
Audio-Einstellbereich	45 dB, einstellbar in 5-dB-Schritten	
Spannungsversorgung	12 V $\overline{\text{---}}$ nom. / 300 mA	12 V $\overline{\text{---}}$ nom. / 500 mA
Rauschsperr (Squelch)	Einstellbar von 3 dBµV bis 28 dBµV (kombiniert mit Pilotton)	
Line-/Mic-Pegel	20 dB umschaltbar	
Gehäusematerial	robustes ABS-Gehäuse	
Abmessungen (B x H x T)	ca. 200 x 42 x 127 mm	ca. 320 x 42 x 127 mm
Gewicht	ca. 340 g	ca. 610 g

Sender

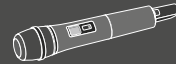

SK-XSW

SKM-XSW

e 825

e 835

HF-Ausgangsleistung	10 mW	
Audio-Übertragungsbereich	50 bis 16 000 Hz (Line) 80 bis 16 000 Hz (Mic)	80 bis 14000 Hz 80 bis 16000 Hz
Audio-Eingang	3,5-mm-Klinkenbuchse	–
Max. Eingangsspannung (Mic/Line) bei 3 % Klirrfaktor	typ. 1,5 V _{RMS} Mic/ typ. 2,6 V _{RMS} Line @ –30 dB Gain	–
Spannungsversorgung	2 Batterien, Typ AA, 1,5 V	2 Batterien, Typ AA, 1,5 V
Betriebszeit	ca. 10 Stunden	
Mikrofontyp	–	Dynamisch
Eingangsempfindlichkeit Kapsel	–	1,5 mV/Pa
Richtcharakteristik	–	Niere
Einstellbereich Sender- empfindlichkeit	0 bis –30 dB einstellbar in 10 dB Schritten	
Gehäusematerial	robustes ABS	
Abmessungen	ca. 71 x 96 x 28 mm (B x H x T)	ca. 260 x 50 mm (L x Ø)
Gewicht	ca. 95 g	ca. 245 g

Mikrofone

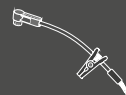
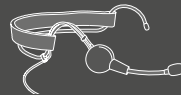

ME 2-2

ME 3-II

e 908T

Wandlerprinzip	Kondensator, dauerpolarisiert	Kondensator, dauerpolarisiert	Kondensator, dauerpolarisiert
Empfindlichkeit	20 mV/Pa	1,6 mV/Pa	0,6 mV/Pa
Richtcharakteristik	Kugel	Niere	Niere
Max. Schalldruckpegel	130 dB	150 dB	147 dB

Netzteil NT 12-5CW

Nenneingangsspannung	100 bis 240 V~
Netzfrequenz	50 oder 60 Hz
Eingangsstrom	≤ 200 mA
Nennausgangsspannung	12 V =
Ausgangsstrom	≤ 500 mA
Stand-by-Leistungsaufnahme	≤ 0,075 W @230 V AC ≤ 0,1 W @115 V AC
Energie-Effizienz-Klasse	DoE Level VI
Temperaturbereich	0 °C bis +40 °C
Lagertemperatur	-20 °C bis +60 °C
Relative Luftfeuchte	max. 95 %
Gewicht (ohne Adapter)	ca. 65 g
Kabellänge	ca. 1,83 m

Steckerbelegung

EM-XSW1

6,3-mm-Mono-Klinkenstecker

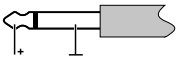

XLR-3-Stecker

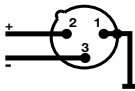

SK-XSW

3,5-mm-Klinkenstecker

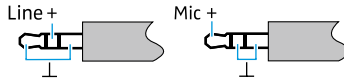



Herstellereklärungen

Garantie

Sennheiser electronic GmbH & Co. KG übernimmt für dieses Produkt eine Garantie von 24 Monaten. Die aktuell geltenden Garantiebedingungen können Sie über das Internet www.sennheiser.com oder Ihren Sennheiser-Partner beziehen.

In Übereinstimmung mit folgenden Anforderungen

- Batterierichtlinie (2013/56/EU & 2006/66/EU)  
- WEEE-Richtlinie (2012/19/EU) 

Hinweise zur Entsorgung

Das Symbol der durchgestrichenen Mülltonne auf Rädern auf Produkt, Batterie/Akku und/oder Verpackung weist Sie darauf hin, dass diese Produkte am Ende ihrer Lebensdauer nicht über den normalen Hausmüll entsorgt werden dürfen, sondern einer separaten Entsorgung zuzuführen sind. Für Verpackungen beachten Sie bitte die gesetzlichen Vorschriften zur Abfalltrennung in Ihrem Land.

Weitere Informationen zum Recycling dieser Produkte erhalten Sie bei Ihrer Gemeindeverwaltung, den kommunalen Sammel- oder Rücknahmestellen oder bei Ihrem Sennheiser-Partner.

Das separate Sammeln von Elektro- und Elektronik-Altgeräten, Batterien/Akkus und Verpackungen dient dazu, die Wiederverwendung und/oder Verwertung zu fördern und negative Effekte, beispielsweise durch potenziell enthaltene Schadstoffe, zu vermeiden. Hiermit leisten Sie einen wichtigen Beitrag zum Umwelt- und Gesundheitsschutz.

CE-Konformität



- RoHS Richtlinie (2011/65/EU)

Hiermit erklärt Sennheiser electronic GmbH & Co. KG, dass der Funkanlagentyp XS WIRELESS 1 bestehend aus SKM-XSW, SK-XSW, EM-XSW1 und EM-XSW1 DUAL der Richtlinie 2014/53/EU entspricht.

Die Erklärung steht Ihnen im Internet unter www.sennheiser.com/download zur Verfügung.

Informationen über Zulassungen und Zertifizierungen finden Sie im Kapitel „Compliance“.

Rahmenbedingungen und Einschränkungen für die Nutzung von Frequenzen

In Ihrem Land gelten möglicherweise gesonderte Rahmenbedingungen und Einschränkungen für die Nutzung von Frequenzen. Informieren Sie sich vor der Inbetriebnahme des Produktes unter folgender Adresse: www.sennheiser.com/frequency-information.

Specifications

System

Modulation	wideband FM
Frequency ranges	A: 548 to 572 MHz GB: 606 to 630 MHz B: 614 to 638 MHz BC: 670 to 694 MHz C: 766 to 790 MHz D: 794 to 806 MHz E: 821 to 832 MHz and 863 to 865 MHz K: 925 to 937.5 MHz
Switching bandwidth	up to 24 MHz
Frequencies	8 frequency banks, each with up to 10 factory-preset channels
Signal-to-noise ratio	≥ 103 dBA
THD	≤ 0.9%
Temperature range	operation: 0°C to +40°C storage: -20°C to +70°C
Transmitter synchronization	2.4 GHz, RF Power <3 mW, Low Power OQPSK (only active during synchronization)

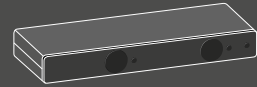

Receiver

	EM-XSW1	EM-XSW1 DUAL
Receiver principle	double superheterodyne	
Diversity principle	antenna switching diversity via internal antennas	
Sensitivity (at peak deviation)	< 3 μ V at 52 dB(A) _{rms} S/N	
AF frequency response	50 to 16,000 Hz (-3 dB)	
Max. AF output voltage (at peak deviation, 1 kHz AF)	1/4" (6.3 mm) jack socket (unbalanced): +6 dBu XLR socket (balanced): +12 dBu	
Audio adjustment range	45 dB, adjustable in 5-dB steps	
Power supply	12 V _{DC} nom. / 300 mA	12 V _{DC} nom. / 500 mA
Squelch	adjustable from 3 dB μ V to 28 dB μ V (combined with pilot tone)	
Line/Mic level	20 dB, switchable	
Housing material	rugged ABS housing	
Dimensions (W x H x D)	approx. 200 x 42 x 127 mm	approx. 320 x 42 x 127 mm
Weight	approx. 340 g	approx. 610 g

Transmitters

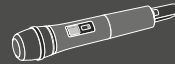

SK-XSW

SKM-XSW

e 825

e 835

RF output power	10 mW	
AF frequency response	50 to 16,000 Hz (Line) 80 to 16,000 Hz (Mic)	80 to 14,000 Hz 80 to 16,000 Hz
Audio input	3.5 mm jack socket	–
Max. input voltage (Mic/Line) at 3% THD	typ. 1.5 V _{RMS} Mic/ typ. 2.6 V _{RMS} Line @ –30 dB Gain	–
Power supply	2 AA size batteries, 1.5 V	2 AA size batteries, 1.5 V
Operating time	approx. 10 hours	
Microphone type	–	dynamic
Input sensitivity (capsule)	–	1.5 mV/Pa
Pick-up pattern	–	cardioid
Adjustment range of transmitter sensitivity	0 to –30 dB, adjustable in 10-dB steps	
Housing material	rugged ABS housing	
Dimensions	approx. 71 x 96 x 28 mm (W x H x D)	approx. 260 x 50 mm (L x Ø)
Weight	approx. 95 g	approx. 245 g

Microphones

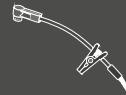
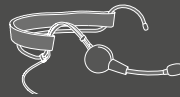

ME 2-2

ME 3-II

e 908T

Transducer principle	condenser, pre-polarized	condenser, pre-polarized	condenser, pre-polarized
Sensitivity	20 mV/Pa	1.6 mV/Pa	0.6 mV/Pa
Pick-up pattern	omni-directional	cardioid	Cardioid
Max. SPL	130 dB	150 dB	147 dB

NT 12-5CW power supply unit

Nominal input voltage	100 to 240 V~
Power frequency	50 or 60 Hz
Input current	≤ max. 200 mA
Nominal output voltage	12 V=
Output current	≤ 500 mA
Standby power consumption	≤ 0.075 W @230 V AC ≤ 0.1 W @115 V AC
Energy efficiency level	DoE Level VI
Temperature range	0°C to +40°C
Storage temperature	-20°C to +60°C
Relative air humidity	max. 95%
Weight (without adapter)	approx. 65 g
Cable length	approx. 1.83 m

Connector assignment

EM-XSW1

1/4" (6.3 mm) mono jack plug

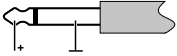

XLR-3 connector

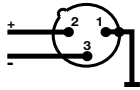

SK-XSW

3.5 mm jack plug



Manufacturer Declarations

Warranty

Sennheiser electronic GmbH & Co. KG gives a warranty of 24 months on this product. For the current warranty conditions, please visit our website at www.sennheiser.com or contact your Sennheiser partner.

For Australia only

Sennheiser goods come with guarantees that cannot be excluded under the Australian Consumer Law. You are entitled to a replacement or refund for a major failure and compensation for any other reasonably foreseeable loss or damage. You are also entitled to have the goods repaired or replaced if the goods fail to be of acceptable quality and the failure does not amount to a major failure.

This warranty is in addition to other rights or remedies under law. Nothing in this warranty excludes, limits or modifies any liability of Sennheiser which is imposed by law, or limits or modifies any remedy available to the consumer which is granted by law.

To make a claim under this warranty, contact

Sennheiser Technical Services and Spare Parts Sales
c/o Linfox, Gate 3, 1 Fox Lane, Erskine Park, 2759, NSW Australia
Phone: (02) 9910 6700
email: au-service@sennheiser.com

All expenses of claiming the warranty will be borne by the person making the claim.

The Sennheiser International Warranty is provided by Sennheiser Australia Pty Ltd (ABN 68 165 388 312), Unit 3, 31 Gibbes Street Chatswood NSW 2067 Australia.

In compliance with the following requirements

- WEEE Directive (2012/19/EU) 
- Battery Directive (2013/56/EU & 2006/66/EU) 

Notes on disposal

The symbol of the crossed-out wheeled bin on the product, the battery/rechargeable battery and/or the packaging indicates that these products must not be disposed of with normal household waste, but must be disposed of separately at the end of their operational lifetime.

Further information on the recycling of these products can be obtained from your municipal administration, from the municipal collection points, or from your Sennheiser partner.

The separate collection of waste electrical and electronic equipment, batteries/rechargeable batteries and packagings is used to promote the reuse and recycling and to prevent negative effects caused by e.g. potentially hazardous substances contained in these products. Herewith you make an important contribution to the protection of the environment and public health.

CE Declaration of Conformity



- RoHS Directive (2011/65/EU)

Hereby, Sennheiser electronic GmbH & Co. KG declares that the radio equipment type XS WIRELESS 1 consisting of SKM-XSW, SK-XSW, EM-XSW1 and EM-XSW1 DUAL is in compliance with Directive 2014/53/EU

The full text of this declaration is available at www.sennheiser.com/download.

Information about approvals and certifications can be found in the "Compliance" section.

Conditions and restrictions for using frequencies

There may be special conditions and restrictions for using frequencies in your country. Before putting the product into operation, find the information for your country at the following address: www.sennheiser.com/frequency-information

DE

EN

FR

IT

ES

PT

NL

PL

SE

DK

FI

GR

RU

ZH

KO

COMPLIANCE

Statements regarding the FCC and Industry Canada rules

This device complies with Part 15 of the FCC Rules. Operation is subject to the following two conditions: (1) This device may not cause harmful interference, and (2) this device must accept any interference received, including interference that may cause undesired operation.

This equipment has been tested and found to comply with the limits for a Class B digital device, pursuant to part 15 of the FCC Rules. These limits are designed to provide reasonable protection against harmful interference in a residential installation. This equipment generates, uses and can radiate radio frequency energy and, if not installed and used in accordance with the instructions, may cause harmful interference to radio communications. However, there is no guarantee that interference will not occur in a particular installation. If this equipment does cause harmful interference to radio or television reception, which can be determined by turning the equipment off and on, the user is encouraged to try to correct the interference by one or more of the following measures:

- Reorient or relocate the receiving antenna.
- Increase the separation between the equipment and receiver.
- Connect the equipment into an outlet on a circuit different from that to which the receiver is connected.
- Consult the dealer or an experienced radio/ TV technician for help.

CAN ICES-3 (B)/NMB-3(B):

This Class B digital apparatus complies with the Canadian ICES-003. Changes or modifications not expressly approved by Sennheiser electronic Corp. could void the user's authority to operate the equipment.

Caractéristiques techniques

Système

Modulation	FM bande large
Plages de fréquences	A : 548 à 572 MHz GB : 606 à 630 MHz B : 614 à 638 MHz BC : 670 à 694 MHz C : 766 à 790 MHz D : 794 à 806 MHz E : 821 à 832 MHz et 863 à 865 MHz K : 925 à 937,5 MHz
Largeur de bande de commutation	jusqu'à 24 MHz
Fréquences	8 banques de fréquences avec respectivement jusqu'à 10 canaux pré-réglés en usine
Rapport signal/bruit	≥ 103 dBA
DHT	≤ 0,9 %
Plage de température	fonctionnement : 0 °C à +40 °C stockage : -20 °C à +70 °C
Synchronisation de l'émetteur	2,4 GHz, RF Power <3 mW, Low Power OQPSK (uniquement actif lors de la synchronisation)

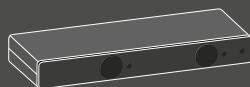

Récepteur

	EM-XSW1	EM-XSW1 DUAL
Principe du récepteur	double superhétérodyne	
Principe Diversity	diversité d'antenne à commutation via antennes internes	
Sensibilité (à excursion crête)	< 3 μV pour 52 dB(A) _{eff} S/N	
Réponse en fréquence	50 à 16 000 Hz (-3 dB)	
Tension de sortie BF (à excursion crête, 1 kHz BF)	prise jack 6,3 mm (asymétrique) : +6 dBu prise XLR (symétrique) : +12 dBu	
Plage de réglage BF	45 dB, réglable par pas de 5 dB	
Alimentation	12 V ⁻⁻⁻ nom. / 300 mA	12 V ⁻⁻⁻ nom. / 500 mA
Squelch	réglable de 3 dBμV à 28 dBμV (en combinaison avec le signal pilote)	
Niveau Line/Mic	20 dB, commutable	
Matériau du boîtier	matériau ABS robuste	
Dimensions (L x H x P)	env. 200 x 42 x 127 mm	env. 320 x 42 x 127 mm
Poids	env. 340 g	env. 610 g

Émetteurs

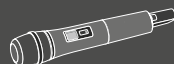

SK-XSW

SKM-XSW

e 825

e 835

Puissance de sortie HF	10 mW	
Réponse en fréquence	50 à 16 000 Hz (Line) 80 à 16 000 Hz (Mic)	80 à 14 000 Hz 80 à 16 000 Hz
Entrée audio	prise jack 3,5 mm	–
Tension d'entrée maxi (Mic/Line) à 3 % DHT	typ. 1,5 V _{RMS} Mic/ typ. 2,6 V _{RMS} Line @ –30 dB gain	–
Alimentation	2 piles de type AA, 1,5 V	2 piles de type AA, 1,5 V
Autonomie	env. 10 heures	
Type de micro	–	dynamique
Sensibilité d'entrée (capsule)	–	1,5 mV/Pa
Directivité	–	cardioïde
Sensibilité de l'émetteur	0 à –30 dB, réglable par pas de 10 dB	
Matériau du boîtier	matériau ABS robuste	
Dimensions	env. 71 x 96 x 28 mm (L x H x P)	env. 260 x 50 mm (L x Ø)
Poids	env. 95 g	env. 245 g

Microphones

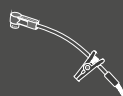
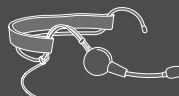

ME 2-2

ME 3-II

e 908T

Principe transducteur	statique, à polarisation permanente	statique, à polarisation permanente	statique, à polarisation permanente
Sensibilité	20 mV/Pa	1,6 mV/Pa	0,6 mV/Pa
Directivité	omnidirectionnelle	cardioïde	cardioïde
Max. SPL	130 dB	150 dB	147 dB

Bloc secteur NT 12-5CW

Tension d'entrée nominale	100 à 240 V~
Fréquence secteur	50 ou 60 Hz
Courant d'entrée	≤ 200 mA
Courant de sortie	≤ 500 mA
Tension de sortie nominale	12 V $\overline{=}$
Consommation en mode veille	≤ 0,075 W @230 V AC ≤ 0,1 W @115 V AC
Catégorie de rendement énergétique	DoE Level VI
Plage de température	0 °C à +40 °C
Température de stockage	-20 °C à +60 °C
Humidité relative de l'air	max. 95 %
Poids (sans adaptateur)	env. 65 g
Longueur du câble	env. 1,83 m

Brochage des connecteurs

EM-XSW1

Jack mono 6,3 mm

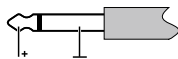

SK-XSW

Connecteur XLR-3

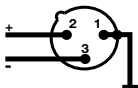

Jack 3,5 mm

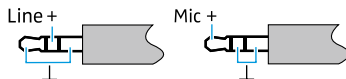



Déclarations du fabricant

Garantie

Sennheiser electronic GmbH & Co. KG offre une garantie de 24 mois sur ce produit. Pour avoir les conditions de garantie actuelles, veuillez visiter notre site web sur www.sennheiser.com ou contacter votre partenaire Sennheiser.

En conformité avec les exigences suivantes

- Directive WEEE (2012/19/UE) 
- Directive Piles et Accumulateurs (2013/56/UE & 2006/66/UE) 

Notes sur la gestion de fin de vie

Le symbole de la poubelle sur roues barrée d'une croix sur le produit, la pile/batterie et/ou l'emballage signifie que ces produits, arrivés en fin de vie, ne doivent pas être jetés dans les ordures ménagères, mais faire l'objet d'une collecte séparée.

Vous obtiendrez plus d'informations sur le recyclage de ces produits auprès de votre municipalité, auprès des points de collecte communaux ou auprès de votre partenaire Sennheiser.

L'objectif principal de la collecte séparée des déchets d'équipements électriques et électroniques, des piles/batteries et des emballages est de promouvoir le réemploi et/ou le recyclage et de prévenir les effets négatifs sur la santé et l'environnement dus à des polluants potentiellement contenus. Vous contribuerez ainsi à la préservation de l'environnement et à la protection de la santé.

Déclaration de conformité pour la CE

- 
- Directive RoHS (2011/65/UE)

Le soussigné, Sennheiser electronic GmbH & Co. KG, déclare que l'équipement radioélectrique du type XS WIRELESS 1 (consistant en SKM-XSW, SK-XSW, EM-XSW1 et EM-XSW1 DUAL) est conforme à la directive 2014/53/UE.

Vous trouverez cette déclaration sur www.sennheiser.com/download.

Vous trouverez des informations relatives aux autorisations et aux certifications dans le chapitre « Compliance ».

Conditions générales et restrictions relatives à l'utilisation de fréquences

Il est possible que des conditions générales et des restrictions spécifiques relatives à l'utilisation de fréquences soient en vigueur dans votre pays. Avant de mettre le produit en service, renseignez-vous en consultant l'adresse suivante : www.sennheiser.com/frequency-information.

Declaration requise par la FCC et l'Industry Canada

Cet appareil est conforme à la Partie 15 des réglementations de la FCC. L'exploitation est autorisée aux deux conditions suivantes :

- (1) L'appareil ne doit pas produire de brouillage, et,
- (2) l'appareil doit accepter tout brouillage radioélectrique subi, même si le brouillage susceptible d'en compromettre le fonctionnement.

Cet appareil est conforme à la Partie 15 des réglementations de la FCC. Son utilisation est soumise à la condition qu'il ne doive pas provoquer d'interférences gênantes..

Les dispositifs fonctionnant dans la bande 5150-5250 MHz sont réservés uniquement pour une utilisation à l'intérieur afin de réduire les risques de brouillage préjudiciable aux systèmes de satellites mobiles utilisant les mêmes canaux.!

Cet équipement a été testé et trouvé conforme aux limites définies pour un dispositif numérique de classe B, dans le cadre de la Partie 15 des réglementations de la FCC. Ces limites sont conçues pour offrir une protection raisonnable contre les interférences nocives pour une installation résidentielle. Cet équipement produit, utilise et peut émettre une énergie haute fréquence et, s'il n'est pas installé et utilisé conformément aux instructions, provoquer des interférences gênantes pour les communications radio. Des risques d'interférences ne peuvent toutefois pas être totalement exclus dans certaines installations. Dans le cas d'interférences gênantes pour la réception des émissions de radio ou télédiffusées (il suffit, pour le constater, d'allumer et d'éteindre l'équipement), l'utilisateur est invité à prendre l'une des mesures suivantes pour les éliminer :

- Réorienter ou déplacer l'antenne réceptrice.
- Eloigner l'équipement du récepteur.
- Brancher l'équipement sur une prise ou un circuit différent de celui du récepteur.
- Consulter un revendeur ou un technicien de radio ou télévision expérimenté.

Toute modification non expressément approuvée par Sennheiser electronic Corp. peut annuler le droit de l'utilisateur à l'emploi de l'équipement en question.

CAN ICES-3 (B)/NMB-3(B):

Cet appareil numérique de la classe B est conforme à la norme NMB-003 du Canada. Avant d'utiliser l'appareil, veuillez observer les dispositions légales en vigueur dans votre pays !

Dati tecnici

Sistema

Modulazione	banda larga FM
Campi di frequenza	A: da 548 a 572 MHz GB: da 606 a 630 MHz B: da 614 a 638 MHz BC: da 670 a 694 MHz C: da 766 a 790 MHz D: da 794 a 806 MHz E: da 821 a 832 MHz e da 863 a 865 MHz K: da 925 a 937,5 MHz
Larghezza di banda di commutazione	Fino a 24 MHz
Frequenze	8 banchi di canali con ciascuno fino a 10 canali preimpostati
Rapporto segnale/rumore	≥ 103 dBA
Distorsione armonica totale	≤ 0,9 %
Campo di temperatura	Durante il funzionamento: da 0 °C a +40 °C Immagazzinamento: da -20 °C a +70 °C
Sincronizzazione trasmettitore	2,4 GHz, RF Power <3 mW, Low Power OQPSK (solo quando la sincronizzazione è attiva)

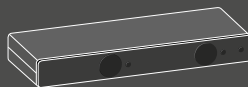

Ricevitore

	EM-XSW1	EM-XSW1 DUAL
Principio di ricezione	Supereterodina a doppia conversione	
Principio di diversità	Antenna Switching Diversity tramite antenne interne	
Sensibilità (con deviazione di picco)	< 3 μV a 52 dB(A) _{eff} S/N	
Gamma di frequenza audio	Da 50 a 16 000 Hz (-3 dB)	
Tensione di uscita audio max. (con deviazione di picco, 1 kHz a bassa frequenza)	Connettore jack 6,3 mm (asimmetrico): +6 dBu Connettore XLR (simmetrico): +12 dBu	
Campo di regolazione audio	45 dB regolabile in passi da 5 dB	
Alimentazione	12 V ^{nom.} / 300 mA	12 V ^{nom.} / 500 mA
Soppressione rumori (squelch)	Regolabile da 3 dBμV a 28 dBμV (in combinazione con tono pilota)	
Livello Line/Mic	20 dB commutabile	
Materiale involucro	Involucro robusto in ABS	
Dimensioni (L x H x P)	Circa 200 x 42 x 127 mm	Circa 320 x 42 x 127 mm
Peso	Circa 340 g	Circa 610 g

Trasmettitore

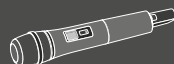

SK-XSW

SKM-XSW

e 825

e 835

Potenza in uscita HF	10 mW	
Gamma di frequenza audio	da 50 a 16 000 Hz (Line) da 80 a 16 000 Hz (Mic)	da 80 a 16 000 Hz
Ingresso audio	Presa jack 3,5 mm	–
Tensione di ingresso max. (Mic/Line) con 3 % di distorsione armonica	tip. 1,5 V _{RMS} Mic/ tip. 2,6 V _{RMS} Line @ -30 dB Gain	–
Alimentazione	2 batterie, tipo AA, 1,5 V	2 batterie, tipo AA, 1,5 V
Tempo di funzionamento	circa 10 ore	
Tipo di microfono	–	dinamico
Sensibilità d'ingresso capsula	–	1,5 mV/Pa
Caratteristiche direzionali	–	cardioide
Campo di regolazione sensibilità trasmettitore	da 0 a -30 dB regolabile in passi da 10 dB	
Materiale involucro	ABS robusto	
Dimensioni	circa 71 x 96 x 28 mm (L x H x P)	circa 260 x 50 mm (L x Ø)
Peso	circa 95 g	circa 245 g

Microfoni

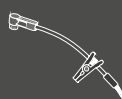
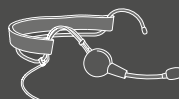

ME 2-2

ME 3-II

e 908T

Principio del convertitore	condensatore, prepolarizzato	condensatore, prepolarizzato	condensatore, prepolarizzato
Sensibilità	20 mV/Pa	1,6 mV/Pa	0,6 mV/Pa
Caratteristiche direzionali	omnidirezionale	cardioide	cardioide
Livello max. di pressione acustica	130 dB	150 dB	147 dB

Alimentatore NT 12-5CW

Tensione d'ingresso nominale	da 100 a 240 V~
Frequenza di rete	50 o 60 Hz
Corrente di ingresso	≤ 200 mA
Tensione nominale d'uscita	12 V=
Corrente d'uscita	≤ 500 mA
Potenza assorbita in stand-by	≤ 0,075 W @230 V AC ≤ 0,1 W @115 V AC
Classe di efficienza energetica	DoE Level VI
Campo di temperatura	da 0 °C a +40 °C
Temperatura di immagazzinamento	da -20 °C a +60 °C
Umidità relativa dell'aria	max. 95%
Peso (senza adattatore)	circa 65 g
Lunghezza del cavo	circa 1,83 m

Disposizione degli attacchi

EM-XSW1

Connettore jack mono 6,3 mm

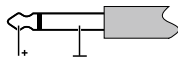

SK-XSW

Connettore XLR-3

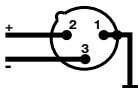

Connettore jack 3,5 mm

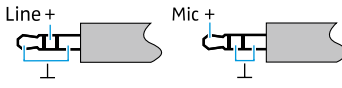



Dichiarazioni del costruttore

Garanzia

Per questo prodotto Sennheiser electronic GmbH & Co. KG offre una garanzia di 24 mesi. Le condizioni di garanzia attualmente valide possono essere consultate sul sito Internet www.sennheiser.com oppure presso un centro servizi Sennheiser.

In conformità alle seguenti prescrizioni

- Direttiva RAEE (2012/19/UE) 
- Direttiva sulle batterie (2013/56/UE & 2006/66/UE) 

Indicazioni per lo smaltimento

Il simbolo barrato del bidone dei rifiuti su ruote, presente sul prodotto o sulle relative pile/batterie e/o confezione, indica che, a utilizzo terminato, i prodotti non possono essere smaltiti con i rifiuti domestici, ma devono essere conferiti in impianti di smaltimento separati. Per quanto riguarda le confezioni, osservare le disposizioni di legge in materia di raccolta differenziata vigenti nel proprio Paese.

Ulteriori informazioni sul riciclo dei presenti prodotti sono disponibili presso la propria amministrazione comunale, nei punti di raccolta o ritiro o presso il centro servizi Sennheiser di fiducia.

La raccolta differenziata di apparecchi elettrici ed elettronici vecchi, di pile/batterie e confezioni serve a incentivare il riutilizzo e/o la valorizzazione dei materiali e a evitare effetti negativi causati, ad es., da sostanze potenzialmente dannose contenute in essi. In tal modo si dà un importante contributo alla tutela dell'ambiente e della salute.

Conformità CE

- 
- Direttiva RoHS (2011/65/UE)

Il fabbricante, Sennheiser electronic GmbH & Co. KG, dichiara che il tipo di apparecchiatura radio XS WIRELESS 1 (composto da SKM-XSW, SK-XSW, EM-XSW1 e EM-XSW1 DUAL) è conforme alla direttiva 2014/53/UE.

La dichiarazione è disponibile in Internet sul sito www.sennheiser.com/download.

Per informazioni sulle omologazioni e sulle certificazioni consultare il capitolo „Compliance“.

Condizioni generali e limitazioni per l'utilizzo delle frequenze

Nel paese di utilizzo possono essere in vigore condizioni generali e limitazioni a parte per l'utilizzo delle frequenze. Prima di mettere in funzione il prodotto informarsi sul seguente sito: www.sennheiser.com/frequency-information

Especificaciones técnicas

Sistema

Tipo de modulación	FM banda ancha
Rangos de frecuencia	A: 548 a 572 MHz GB: 606 a 630 MHz B: 614 a 638 MHz BC: 670 a 690 MHz C: 766 a 790 MHz D: 794 a 806 MHz E: 821 a 832 MHz y 863 a 865 MHz K: 925 a 937,5 MHz
Ancho de banda de conmutación	Hasta 24 MHz
Frecuencias	8 bancos de canales con hasta 10 canales preajustados cada uno
Separación señal / ruido	≥ 103 dBA
Distorsión armónica total	≤ 0,9 %
Rango de temperatura	Funcionamiento: 0 °C a +40 °C Almacenamiento: -20 °C a +70 °C
Sincronización de transmisor	2,4 GHz, RF Power <3 mW, Low Power OQPSK (sólo mientras la sincronización esté activa)

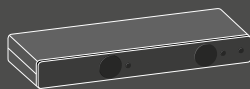

Receptor

	EM-XSW1	EM-XSW1 DUAL
Principio del receptor	Double-Superheterodyn	
Principio de diversity	Antenna Switching Diversity mediante antenas internas	
Sensibilidad (con desviación punta)	< 3 μ V a 52 dB(A) _{eff} S/N	
Respuesta de frecuencia de audio	50 a 16 000 Hz (-3 dB)	
Tensión de salida de audio máx. (con desviación punta, 1 kHz baja frecuencia)	Jack hembra de 6,3 mm (asimétrico): +6 dBu Conector hembra XLR (simétrico): +12 dBu	
Rango de ajuste de audio	45 dB, ajustable en pasos de 5 dB	
Fuente de alimentación	12 V ⁻⁻⁻ nom. / 300 mA	12 V ⁻⁻⁻ nom. / 500 mA
Supresión de ruidos (Squelch)	Ajustable de 3 dB μ V a 28 dB μ V (combinada con tono piloto)	
Nivel Line/Mic	20 dB conmutable	
Material de la carcasa	Robusta carcasa de ABS	
Dimensiones (An x Al x Pro)	Aprox. 200 x 42 x 127 mm	Aprox. 320 x 42 x 127 mm
Peso	Aprox. 340 g	Aprox. 610 g

Transmisor

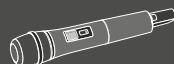

SK-XSW

SKM-XSW

e 825

e 835

Potencia de salida de RF	10 mW	
Respuesta de frecuencia de audio	50 a 16000 Hz (Line) 80 a 16000 Hz (Mic)	80 a 14000 Hz 80 a 16000 Hz
Entrada de audio	Jack hembra de 3,5 mm	–
Tensión máx. de entrada (Mic/Line) con 3 % de distorsión armónica	típ. 1,5 V _{RMS} Mic/ típ. 2,6 V _{RMS} Line @ –30 dB de ganancia	–
Fuente de alimentación	2 baterías, tipo AA, 1,5 V	2 baterías, tipo AA, 1,5 V
Autonomía	aprox. 10 horas	
Tipo de micrófono	–	Dinámico
Sensibilidad de entrada de la cápsula	–	1,5 mV/Pa
Patrón de captación	–	Cardioide
Rango de ajuste de sensibilidad del transmisor	0 a –30 dB ajustables en pasos de 10 dB	
Material de la carcasa	ABS resistente	
Dimensiones	aprox. 71 x 96 x 28 mm (An x Al x Pro)	260 x 50 mm (L x Ø)
Peso	aprox. 95 g	aprox. 245 g

Micrófonos

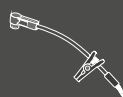
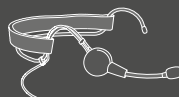

ME 2-2

ME 3-II

e 908T

Principio del transductor	Condensador, polarización permanente	Condensador, polarización permanente	Condensador, polarización permanente
Sensibilidad	20 mV/Pa	1,6 mV/Pa	0,6 mV/Pa
Patrón de captación	Omni-direccional	Cardioide	Cardioide
Nivel de presión de sonido máx.	130 dB	150 dB	147 dB

Fuente de alimentación NT 12-5CW

Tensión de entrada nominal	100 a 240 V~
Frecuencia de red	50 o 60 Hz
Corriente de entrada	máx. 200 mA
Tensión nominal de salida	12 V $\overline{\text{=}}$
Corriente de salida	\leq 500 mA
Consumo de potencia en standby	\leq 0,075 W @230 V AC \leq 0,1 W @115 V AC
Clase de eficiencia energética	DoE Level VI
Rango de temperatura	0 °C a +40 °C
Temperatura de almacenamiento	-20 °C a +60 °C
Humedad relativa del aire	máx. 95 %
Peso (sin adaptador)	aprox. 65 g
Longitud del cable	aprox. 1,83 m

Asignación de conectores

EM-XSW1

Jack mono 6,3 mm

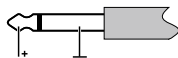

SK-XSW

Conector XLR-3

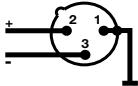

Jack 3,5 mm



Declaraciones del fabricante

Garantía

Sennheiser electronic GmbH & Co. KG concede una garantía de 24 meses por este producto. Puede consultar las condiciones de garantía actuales en la página de Internet www.sennheiser.com u obtenerlas de su distribuidor Sennheiser.

Conformidad con las siguientes directivas

- Directiva sobre baterías (2013/56/UE & 2006/66/UE)



- Directiva WEEE (2012/19/UE)



Instrucciones para el desecho

El símbolo tachado del contenedor de basura sobre ruedas en el producto, la batería/pila recargable y/o el envase advierte de que estos productos no se deben desechar con la basura doméstica al final de su vida útil, sino que deben desecharse por separado. Para los envases, observe las prescripciones legales sobre separación de desechos de su país.

Obtendrá más información sobre el reciclaje de estos productos en la administración de su municipio, en los puntos de recogida o devolución municipales o de su proveedor Sennheiser.

La recolección por separado de aparatos viejos eléctricos y electrónicos, baterías/pilas recargables y envases sirve para promover la reutilización y/o el reciclaje y evitar efectos negativos, por ejemplo, los que puedan causar los contaminantes que contengan. Así hará una contribución muy importante para proteger nuestro medioambiente y la salud humana.

Conformidad CE



- Directiva RoHS (2011/65/UE)

Por la presente, Sennheiser electronic GmbH & Co. KG declara que el tipo de equipo radioeléctrico XS WIRELESS 1 (compuesto de SKM-XSW, SK-XSW, EM-XSW1 y EM-XSW1 DUAL) es conforme con la Directiva 2014/53/UE.

La declaración se puede consultar en Internet: www.sennheiser.com/download.

Encontrará información sobre las homologaciones y certificaciones en el capítulo «Compliance».

Condiciones marco y limitaciones sobre la utilización de frecuencias

Es posible que en su país tengan validez condiciones marco y limitaciones especiales sobre la utilización de frecuencias. Antes de poner el producto en funcionamiento, infórmese al respecto en la dirección siguiente: www.sennheiser.com/frequency-information

Dados técnicos

System

Tipo de modulação	FM de banda larga
Gamas de frequência	A: 548 a 572 MHz GB: 606 a 630 MHz B: 614 a 638 MHz BC: 670 a 694 MHz C: 766 a 790 MHz D: 794 a 806 MHz E: 821 a 832 MHz e 863 a 865 MHz K: 925 a 937,5 MHz
Largura de banda de frequência de comutação	Até 24 MHz
Frequências	8 bancos de canais com até 10 canais predefinidos cada
Relação de sinal-ruído	≥ 103 dBA
Distorção harmónica	≤ 0,9 %
Intervalo de temperatura	Em funcionamento: 0 °C a +40 °C Armazenamento: -20 °C a +70 °C
Sincronização do emissor	2,4 GHz, RF Power <3 mW, Low Power OQPSK (ativo apenas durante a sincronização)

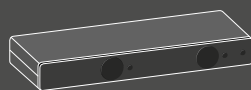

Recetor

	EM-XSW1	EM-XSW1 DUAL
Princípio de receção	Duplo super-heteródino	
Princípio Diversity	Antenna Switching Diversity através das antenas internas	
Sensibilidade (com desvio máximo)	< 3 µV com 52 dB(A) _{eff} S/N	
Intervalo de transmissão de som	50 a 16 000 Hz (-3 dB)	
Tensão de saída de som máx. (com desvio máximo, 1 kHz NF)	Conector jack fêmea de 6,3 mm (não balanceado): +6 dBu Conector XLR fêmea (balanceado): +12 dBu	
Intervalo de ajuste de som	45 dB, ajustável em intervalos de 5 dB	
Alimentação de tensão	12 V ^{DC} nom./300 mA	12 V ^{DC} nom./500 mA
Silenciador automático de ruídos de fundo (Squelch)	Ajustável de 3 dBµV a 28 dBµV (combinado com tom piloto)	
Volume Line/Mic	20 dB comutável	
Material da carcaça	Carcaça ABS robusta	
Dimensões (L x A x P)	Aprox. 200 x 42 x 127 mm	Aprox. 320 x 42 x 127 mm
Peso	Aprox. 340 g	Aprox. 610 g

Emissor

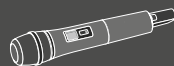

	SK-XSW	SKM-XSW	
		e 825	e 835
Potência de saída de RF	10 mW		
Intervalo de transmissão de som	50 a 16 000 Hz (Line) 80 a 16 000 Hz (Mic)	80 a 14 000 Hz	80 a 16 000 Hz
Entrada de áudio	Conector jack fêmea de 3,5 mm	-	
Tensão de entrada máx. (Mic/Line) com 3 % de distorção harmônica	tipo 1,5 V _{RMS} Mic/ tipo 2,6 V _{RMS} Line @ -30 dB Gain	-	
Alimentação de tensão	2 pilhas de 1,5 V, tipo AA	2 pilhas de 1,5 V, tipo AA	
Tempo de funcionamento	Aprox. 10 horas		
Tipo de microfone	-	Dinâmico	
Sensibilidade de entrada da cápsula	-	1,5 mV/Pa	
Característica direcional	-	Cardioide	
Intervalo de ajuste da sensibilidade do emissor	Ajustável de 0 a -30 dB em intervalos de 10 dB		
Material da carcaça	ABS robusto		
Dimensões	Aprox. 71 x 96 x 28 mm (L x A x P)	Aprox. 260 x 50 mm (C x Ø)	
Peso	Aprox. 95 g	Aprox. 245 g	

Microfones

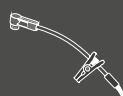
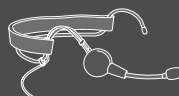

	ME 2-2	ME 3-II	e 908T
Princípio do conversor	Condensador, permanentemente polarizado	Condensador, permanentemente polarizado	Condensador, permanentemente polarizado
Sensibilidade	20 mV/Pa	1,6 mV/Pa	0,6 mV/Pa
Característica direcional	Omnidirecional	Cardioide	Cardioide
Nível máx. de pressão sonora	130 dB	150 dB	147 dB

Alimentador NT 12-5CW

Tensão de entrada nominal	100 a 240 V~
Frequência de rede	50 ou 60 Hz
Corrente de entrada	≤ 200 mA
Tensão de saída nominal	12 V=
Corrente de saída	≤ 500 mA
Consumo de potência em standby	≤ 0.075 W @230 V AC ≤ 0.1 W @115 V AC
Classe de eficiência energética	DoE Level VI
Intervalo de temperatura	0 °C a +40 °C
Temperatura de armazenamento	-20 °C a +60 °C
Humidade relativa do ar	Máx. 95 %
Peso (sem adaptador)	Aprox. 65 g
Comprimento do cabo	Aprox. 1,83 m

Pinagem

EM-XSW1

Conector jack macho mono de 6,3 mm

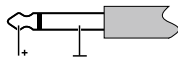

Conector XLR-3

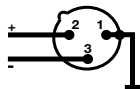

SK-XSW

Conector jack macho de 3,5 mm

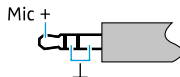
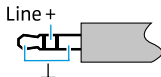



Declarações do fabricante

Garantia

A Sennheiser electronic GmbH & Co. KG assume uma garantia de 24 meses para este produto. As condições de garantia atuais encontram-se disponíveis no nosso site da Internet www.sennheiser.com ou junto do seu distribuidor Sennheiser.

Em conformidade com as seguintes diretivas

- Diretiva REEE (2012/19/UE) 
- Diretiva relativa às pilhas (2013/56/UE & 2006/66/UE) 

Indicações sobre a eliminação

O símbolo do contentor de lixo com rodas barrado com uma cruz que se encontra no produto, na pilha/bateria e/ou na embalagem, alerta-o para o facto de que estes produtos não podem ser eliminados no lixo doméstico normal no fim da sua vida útil, mas devem ser eliminados separadamente. Para as embalagens, por favor, respeite as prescrições legais em vigor no seu país sobre a separação de resíduos.

Obtenha mais informações sobre a reciclagem destes produtos junto da câmara municipal, do centro ou ponto de recolha local ou do seu parceiro Sennheiser.

A recolha separada de aparelhos elétricos e eletrónicos antigos, pilhas/baterias e embalagens serve para promover a reciclagem e/ou reutilização e evitar efeitos negativos causados, por exemplo, por substâncias potencialmente nocivas. Assim, contribui significativamente para a proteção do ambiente e da saúde.

Conformidade CE

- 
- Diretiva RoHS (2011/65/UE)

O abaixo assinado Sennheiser electronic GmbH & Co. KG declara que o presente tipo de equipamento de rádio XS WIRELESS 1 (composto por SKM-XSW, SK-XSW, EM-XSW1 e EM-XSW1 DUAL) está em conformidade com a Diretiva 2014/53/UE.

A declaração encontra-se disponível no nosso site da Internet www.sennheiser.com/download. As informações sobre as homologações e as certificações podem ser consultadas no capítulo „Compliance“.

Condições adicionais e restrições para a utilização de frequências

Provavelmente, no seu país aplicam-se condições adicionais e restrições especiais à utilização de frequências. Antes da colocação em funcionamento do produto, consulte o seguinte endereço: www.sennheiser.com/frequency-information

Technische specificaties

System

Modulatiewijze	Breedband-FM
Frequenties	A: 548 tot 572 MHz GB: 606 tot 630 MHz B: 614 tot 638 MHz BC: 670 tot 694 MHz C: 766 tot 790 MHz D: 794 tot 806 MHz E: 821 tot 832 MHz en 863 tot 865 MHz K: 925 tot 937,5 MHz
Schakelbandbreedte	Tot max. 24 MHz
Frequenties	8 kanaalbanken met maximaal 10 vooraf ingestelde kanalen
Signaal-/ruisverhouding	≥ 103 dBA
Vervormingsfactor	≤ 0,9%
Temperatuurbereik	In bedrijf: 0°C tot +40°C Opslag: -20°C tot +70°C
Synchronisatie van de zender	2,4 GHz, RF Power <3 mW, Low Power OQPSK (alleen actief tijdens de synchronisatie)

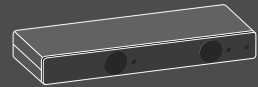

Ontvanger

	EM-XSW1	EM-XSW1 DUAL
Ontvangerprincipe	Double-superheterodyn	
Diversity-principe	Antenna switching diversity via interne antennes	
Gevoeligheid (bij piekslag)	< 3 μV bij 52 dB(A) _{eff} S/N	
Audiofrequentie	50 tot 16.000 Hz (-3 dB)	
Max. audio-uitgangsspanning (bij piekslag, 1 kHz NF)	6,3 mm jackplug (niet-symmetrisch): +6 dBu XLR-bus (symmetrisch) +12 dBu	
Audio-instelbereik	45 dB, in stappen van 5 dB instelbaar	
Voedingsspanning	12 V ⁻⁻⁻ nom./300 mA	12 V ⁻⁻⁻ nom./500 mA
Ruisfilter (squelch)	Instelbaar van 3 dBμV tot 28 dBμV (gecombineert met pilot-toon)	
Line-/mic-piek	20 dB omschakelbaar	
Behuizingsmateriaal	Robuuste ABS-behuizing	
Afmetingen (bxhxd)	Ca. 200 x 42 x 127 mm	Ca. 320 x 42 x 127 mm
Gewicht	Ca. 340 g	Ca. 610 g

Zender

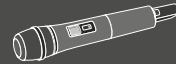

SK-XSW

SKM-XSW

e 825

e 835

HF-uitgangsvermogen	10 mW	
Audiofrequentie	50 tot 16.000 Hz (line) 80 tot 16.000 Hz (mic)	80 tot 14.000 Hz 80 tot 16.000 Hz
Audio-ingang	3,5-mm jackplug	–
Max. ingangsspanning (mic/line) bij een vervormingsfactor van 3%	typ. 1,5 V _{RMS} mic/ typ. 2,6 V _{RMS} line @ –30 dB gain	–
Voedingsspanning	2 batterijen, type AA, 1,5 V	2 batterijen, type AA, 1,5 V
Bedrijfstijd	ca. 10 uur	
Microfoontype	–	Dynamisch
Ingangsgevoeligheid kapsel	–	1,5 mV/Pa
Richtkarakteristiek	–	Nier
Instelbereik van de zendergevoeligheid	0 tot –30 dB in stappen van 10 dB instelbaar	
Behuizingsmateriaal	robuust ABS	
Afmetingen	ca. 71 x 96 x 28 mm (bx dx h)	ca. 260 x 50 mm (lx Ø)

Microfoons

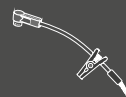
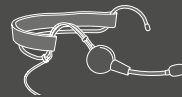

ME 2-2

ME 3-II

e 908T

Omvormerprincipe	Condensator, permanent gepolariseerd	Condensator, permanent gepolariseerd	Condensator, permanent gepolariseerd
Gevoeligheid	20 mV/Pa	1,6 mV/Pa	0,6 mV/Pa
Richtkarakteristiek	Kogel	Nier	Nier
Max. geluidsdruk	130 dB	150 dB	147 dB

Voedingsadapter NT12-5CW

Nominale ingangsspanning	100 tot 240 V~
Netfrequentie	50 of 60 Hz
Ingangsstroomsterkte	≤ 200 mA
Nominale uitgangsspanning	12 V=
Uitgangsstroomsterkte	≤ 500 mA
Stand-by stroomverbruik	≤ 0,075 W @230 V AC ≤ 0,1 W @115 V AC
Energie-efficiencyklasse	DoE Level VI
Temperatuurbereik	0°C tot +40°C
Opslagtemperatuur	-20°C tot +60°C
Relatieve luchtvochtigheid	max. 95%
Gewicht (zonder adapter)	ca. 65 g
Kabellengte	ca. 1,83 m

Stekkeraansluitingen

EM-XSW1

6,3-mm-mono-jackplug

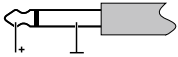

XLR-3-stekker

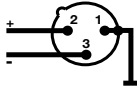

SK-XSW

3,5 mm jackplug





Verklaringen van de fabrikant

Garantie

Sennheiser electronic GmbH & Co. KG verleent op dit product een garantie van 24 maanden. De op dit moment geldende garantiebepalingen kunt u downloaden van het internet onder www.sennheiser.com of bij uw Sennheiser-leverancier opvragen.

In overeenstemming met onderstaande eisen

- WEEE-richtlijn (2012/19/EU) 
- Batterijrichtlijn (2013/56/EU & 2006/66/EU) 

Aanwijzingen voor het behandelen als afval

Symbolen van bijv. een afvalcontainer, batterij/accu en/of verpakking met een streep erdoor wil zeggen dat deze producten aan het einde van hun levensduur niet via het huishoudelijke afval mogen worden afgevoerd, maar naar een aparte inzamelplaats moet worden afgevoerd. Zie voor verpakkingen a.u.b. de wettelijke voorschriften voor het gescheiden inleveren van afval in uw land.

Meer informatie over het recyclen van dit product kunt u opvragen bij uw gemeentelijke autoriteiten, de gemeentelijk inzamelplaatsen of uw Sennheiser-leverancier.

Het gescheiden inzamelen van oude elektrische en elektronische apparaten, batterijen/accu's en verpakkingen heeft tot doel het hergebruik en/of de terugwinning van grondstoffen te stimuleren en negatieve effecten, bijv. door eventueel aanwezige giftige stoffen, te voorkomen. Hiermee levert u een belangrijke bijdrage aan de bescherming van het milieu en de gezondheid.

CE-overeenstemming

- 
- RoHS-richtlijn (2011/65/EU)

Hierbij verklaar ik, Sennheiser electronic GmbH & Co. KG, dat het type radioapparatuur XS WIRELESS 1 (bestaande uit SKM-XSW, SK-XSW, EM-XSW1, EM-XSW1 DUAL) conform is met Richtlijn 2014/53/EU.

De verklaring is op internet onder www.sennheiser.com/download beschikbaar.

Informatie over vergunningen en certificeringen vindt u in het hoofdstuk „Compliance“.

Randvoorwaarden en beperkingen voor het gebruik van frequenties

In uw land gelden mogelijk andere randvoorwaarden en beperkingen voor het gebruik van frequenties. Zie voor de inbedrijfstelling van het product eerst de informatie onder het onderstaande adres: www.sennheiser.com/frequency-information

Dane techniczne

System

Rodzaj modulacji	Szerokopasmowa
Zakresy częstotliwości	A: od 548 do 572 MHz GB: od 606 do 630 MHz B: od 614 do 638 MHz BC: od 670 do 694 MHz C: od 766 do 790 MHz D: od 794 do 806 MHz E: od 821 do 832 MHz i od 863 do 865 MHz K: od 925 do 937,5 MHz
Szerokość pasma	Do 24 MHz
Częstotliwości	8 ścieżek kanałów, każda z maks. 10 wstępnie ustawionymi kanałami
Stosunek sygnału do szumu	≥ 103 dBA
Współczynnik zniekształceń nieliniowych	$\leq 0,9$ %
Zakres temperatur	Eksploatacja: od 0 °C do +40 °C Przechowywanie: od -20 °C do +70 °C
Synchronizacja nadajnika	2,4 GHz, RF Power <3 mW, Low Power OQPSK (aktywny tylko podczas synchronizacji)

Odbiornik

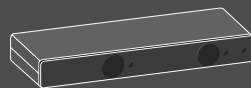

	EM-XSW1	EM-XSW1 DUAL
Zasada odbiornika	Odbiornik superheterodynowy z podwójną przemianą częstotliwości	
Zasada dywersyfikacji	Dywersyfikacja anten poprzez anteny wewnętrzne	
Czułość (przy skoku maksymalnym)	$< 3 \mu\text{V}$ przy 52 dB(A) _{eff} S/N	
Pasma przenoszenia audio	50 do 16 000 Hz (-3 dB)	
Maks. Napięcie wyjściowe audio (przy skoku maksymalnym, 1 kHz NF)	Gniazdo jack 6,3 mm (niesymetryczne): +6 dBu Gniazdo XLR (symetryczne): +12 dBu	
Zakres ustawiania audio	45 dB, ustawialne w 5 krokach dB	
Zasilanie napięciowe	12 V _{nom.} / 300 mA	12 V _{nom.} / 500 mA
Blokada szumów (squelch)	Ustawialne od 3 dB μV do 28 dB μV (w połączeniu z sygnałem pilota)	
Poziom Line/Mic	20 dB możliwe do przełączenia	
Materiał obudowy	Solidna obudowa ABS	
Wymiary (szer. x wys. x gł.)	ok. 200 x 42 x 127 mm	ok. 320 x 42 x 127 mm
Waga	ok. 340 g	ok. 610 g

Nadajnik

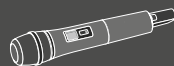

SKM-XSW

SKM-XSW

e 825

e 835

Moc wyjściowa HF	10 mW		
Pasma przenoszenia audio	od 50 do 16 000 Hz (Line) od 80 do 16 000 Hz (Mic)	od 80 do 14000 Hz	od 80 do 16000 Hz
Wejście audio	Gniazdo jack 3,5 mm		–
Maks. napięcie wejściowe (Mic/Line) przy 3 % współczynnika zniekształceń nieliniowych	typ. 1,5 V _{RMS} Mic/ typ. 2,6 V _{RMS} Line @ –30 dB Gain		–
Zasilanie napięciowe	2 baterie typ AA, 1,5 V		2 baterie typ AA, 1,5 V
Czas pracy	ok. 10 godzin		
Typ mikrofonu	–	Dynamiczny	
Czułość wejściowa gniazda, zamknięcie	–	1,5 mV/Pa	
Charakterystyka kierunkowości	–	Kardioidalna	
Zakres ustawień czułości nadajnika	0 do –30 dB ustawialne w 10 krokach dB		
Materiał obudowy	Solidna obudowa ABS		
Wymiary	ok. 71 x 96 x 28 mm (szer. x wys. x gł.)	ok. 260 x 50 mm (dł. x Ø)	
Waga	ok. 95 g	ok. 245 g	

Mikrofony

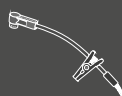
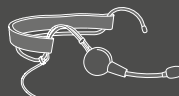

ME 2-2

ME 3-II

e 908T

Przetwornik	Kondensator, stale spolaryzowany	Kondensator, stale spolaryzowany	Kondensator, stale spolaryzowany
Czułość	20 mV/Pa	1,6 mV/Pa	0,6 mV/Pa
Charakterystyka kierunkowości	Dookolna	Kardioidalna	Kardioidalna
Maks. poziom ciśnienia akustycznego	130 dB	150 dB	147 dB

Sieć NT 12-5CW

Znamionowe napięcie wejściowe	od 100 do 240 V~
Częstotliwość sieci	50 lub 60 Hz
Prąd wejściowy	≤ 200 mA
Znamionowe napięcie wyjściowe	12 V $\overline{=}$
Prąd wyjściowy	≤ 500 mA
Pobór mocy w trybie gotowości	≤ 0,075 W @230 V AC ≤ 0,1 W @115 V AC
Klasa wydajności energetycznej	DoE Level VI
Zakres temperatur	od 0 °C do +40 °C
Temperatura przechowywania	od -20 °C do +60 °C
Względna wilgotność powietrza	maks. 95 %
Waga (bez adaptera)	<ok. 65 g
Długość przewodu	<ok. 1,83 m

Przypisanie pinów

EM-XSW1

Wtyk jack 6,3 mm mono

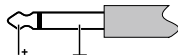

SK-XSW

Wtyk XLR-3

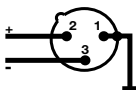

Wtyk jack 3,5 mm

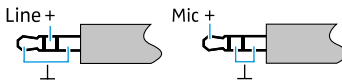

Deklaracje producenta

Gwarancja

Sennheiser electronic GmbH & Co. KG udziela na ten produkt 24-miesięcznej gwarancji. Aktualnie obowiązujące warunki gwarancji można uzyskać w Internecie na stronie www.sennheiser.com lub u przedstawiciela firmy Sennheiser.

Zgodnie z następującymi wymaganiami

- Dyrektywa WEEE (2012/19/UE) 
- Dyrektywa w sprawie baterii i akumulatorów (2013/56/UE & 2006/66/UE) 

Informacje dotyczące utylizacji

Symbol przekreślonego śmietnika na kółkach, umieszczony na produkcie, baterii / akumulatorze i / lub opakowaniu, oznacza, że produktów tych nie należy wyrzucać do pojemnika na zwykłe odpady komunalne po zakończeniu ich eksploatacji, lecz należy je przekazać do specjalnego punktu recyklingu. W przypadku opakowań prosimy uwzględnić krajowe przepisy ustawowe dotyczące segregacji odpadów.

Dalsze informacje dotyczące recyklingu tych produktów można uzyskać w lokalnym urzędzie gminy, komunalnych punktach zbiórki odpadów lub u lokalnego przedstawiciela firmy Sennheiser.

Oddzielne zbieranie zużytych urządzeń elektrycznych i elektronicznych, baterii / akumulatorów i opakowań służy wspieraniu odzysku i/lub ponownego wykorzystania surowców wtórnych oraz minimalizowaniu ich negatywnych skutków, np. ze względu zawartość potencjalnie szkodliwych substancji. W ten sposób przyczyniają się Państwo do ochrony środowiska i zdrowia.

Zgodność WE

- 
- Dyrektywa RoHS (2011/65/UE)

Sennheiser electronic GmbH & Co. KG niniejszym oświadcza, że typ urządzenia radiowego XS WIRELESS 1 (składa się z SKM-XSW, SK-XSW, EM-XSW1, EM-XSW1 DUAL) jest zgodny z dyrektywą 2014/53/UE.

Deklaracja jest dostępna w Internecie na stronie www.sennheiser.com/download.

Informacje dotyczące atestów i certyfikatów znajdują się w rozdziale „Compliance”.

Warunki ramowe i ograniczenia dotyczące wykorzystania częstotliwości

Prawdopodobnie w Państwa kraju obowiązują specjalne warunki ramowe i ograniczenia dotyczące wykorzystania częstotliwości. Proszę przez uruchomieniem produktu zasięgnąć odpowiednich informacji pod adresem: www.sennheiser.com/frequency-information.

Tekniska data

System

Modulationstyp	Bredbands-FM
Högfrekvensomfång	A: 548 till 572 MHz GB: 606 till 630 MHz B: 614 till 638 MHz BC: 670 till 694 MHz C: 766 till 790 MHz D: 794 till 806 MHz E: 821 till 832 MHz och 863 till 865 MHz K: 925 till 937,5 MHz
Kanalbandsbredd	Upp till 24 MHz
Frekvenser	8 kanaler med upp till 10 förinställda kanaler vardera
Signalbrusavstånd	≥ 103 dBA
Övertonshalt	≤ 0,9 %
Temperaturområde	Vid användning: 0 °C till +40 °C Förvaring: -20 °C till +70 °C
Sändarsynkronisering	2,4 GHz, RF Power <3 mW, Low Power OQPSK (endast aktiv under synkronisering)

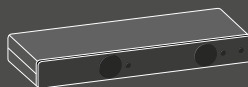

Mottagare

	EM-XSW1	EM-XSW1 DUAL
Mottagningsprincip	Double-superheterodyn	
Diversity-princip	Antenna Switching Diversity via interna antenner	
Känslighet (vid peak)	< 3 μ V vid 52 dB(A) _{eff} S/N	
Ljudöverföringsområde	50 till 16 000 Hz (-3 dB)	
Max. ljudutspänning (vid peak, 1 kHz LF)	6,3 mm-honkontakt (osymmetrisk): +6 dBu XLR-uttag (symmetrisk): +12 dBu	
Ljudinställningsområde	45 dB, kan ställas in i 5 dB-steg	
Strömförsörjning	12 V --- nom./300 mA	12 V --- nom./500 mA
Brusspär (squelch)	Kan ställas in mellan 3 dB μ V och 28 dB μ V (i kombination med pilotton)	
Line/Mic-nivå	20 dB omkopplingsbar	
Höljesmaterial	Robust ABS-hölje	
Mått (B x H x D)	Ca 200 x 42 x 127 mm	Ca 320 x 42 x 127 mm
Vikt	Ca 340 g	Ca 610 g

Sändare

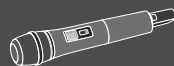

	SK-XSW	SKM-XSW	
		e 825	e835
HF-uteffekt	10 mW		
Ljudöverföringsområde	50 till 16 000 Hz (Line) 80 till 16 000 Hz (Mic)	80 till 14000 Hz	80 till 16000 Hz
Ljudingång	3,5 mm-honkontakt	–	
Max. inspänning (Mic/Line) vid 3 % övertonshalt	Normalt 1,5 V _{RMS} Mic/ normalt 2,6 V _{RMS} Line @ -30 dB Gain	–	
Strömförsörjning	2 batterier, typ AA, 1,5 V	2 batterier, typ AA, 1,5 V	
Funktionstid	ca 10 timmar		
Mikrofontyp	–	Dynamisk	
Kapselns ingångskänslighet	–	1,5 mV/Pa	
Riktningsskarakteristik	–	Kardioid	
Inställningsområde sändarens känslighet	0 till -30 dB kan ställas in i 10 dB-steg		
Höljesmaterial	Robust ABS		
Mått	Ca 71 x 96 x 28 mm (B x H x D)	Ca 260 x 50 mm (L x Ø)	
Vikt	Ca 95 g	Ca 245 g	

Mikrofoner

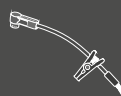
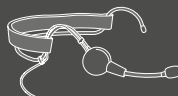

	ME 2-2	ME 3-II	e 908T
Omvandlingsprincip	Kondensator, konstant polariserad	Kondensator, konstant polariserad	Kondensator, konstant polariserad
Känslighet	20 mV/Pa	1,6 mV/Pa	0,6 mV/Pa
Riktningsskarakteristik	Kula	Kardioid	Kardioid
Max. ljudtrycksnivå	130 dB	150 dB	147 dB

Nätadapter NT 12-5CW

Nominell inspänning	100 till 240 V~
Nätfrekvens	50 eller 60 Hz
Inström	≤ 200 mA
Nominell utspänning	12 V 
Utström	≤ 500 mA
Utström	≤ 0,075 W @230 V AC
	≤ 0,1 W @115 V AC
Standby-effektförbrukning	≤ 0,1 W
Energieffektivitetsklass	Doe Level VI
Temperaturområde	0 °C till +40 °C
Lagringstemperatur	-20 °C till +60 °C
Relativ luftfuktighet	max. 95 %
Vikt (utan adapter)	Ca 65 g
Kabellängd	Ca 1,83 m

Kontaktschema

EM-XSW1

6,3 mm-monohankontakt

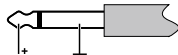

SK-XSW

XLR 3-kontakt

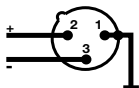

3,5 mm-hankontakt





Tillverkarintyg

Garanti

Sennheiser electronic GmbH & Co. KG ger en garanti på 24 månader för den här produkten. Aktuella garantivillkor finns på internet på www.sennheiser.com eller hos din Sennheiser-återförsäljare.

Produkten överensstämmer med följande krav

- WEEE-direktivet (2012/19/EU) 
- Batteridirektivet (2013/56/EU & 2006/66/EU) 

Avfallshantering

Symbolen med den överstrukna soptunnan på produkten, batterier/uppladdningsbara batterier och/eller förpackningen anger att dessa produkter inte får slängas som vanligt hushållsavfall utan måste sorteras separat. Förpackningar ska sorteras enligt gällande avfallsbestämmelser i ditt land.

Mer information om hur dessa produkter ska återvinnas kan du få från din kommun, miljöstation eller återvinningscentral eller av din Sennheiser-återförsäljare.

Ett separat insamlande av gamla elektriska och elektronisk apparater, batterier/uppladdningsbara batterier och förpackningar har som syfte att främja återvinningen och/eller att förebygga negativa effekter exempelvis orsakade av skadliga ämnen. På detta sätt bidrar du till att skydda miljön och vår hälsa.

CE-överensstämmelse

- 
- RoHS-direktivet (2011/65/EU)

Härmed försäkras Sennheiser electronic GmbH & Co. KG att denna typ av radioutrustning XS WIRELESS 1 (består av SKM-XSW, SK-XSW, EM-XSW1 och EM-XSW1 DUAL) överensstämmer med direktiv 2014/53/EU.

Intygen finns på Internet på www.sennheiser.com/download.

Information om godkännanden och certifieringar finns i kapitel „Compliance“.

Förutsättningar och begränsningar för användning av frekvenser

Eventuellt gäller särskilda förutsättningar och begränsningar för användning av frekvenser i ditt land.. Ta reda på mer innan produkten används på: www.sennheiser.com/frequency-information.

Tekniske data

System

Modulationstype	Bredbånd-FM
Frekvensområder	A: 548 til 572 MHz GB: 606 til 630 MHz B: 614 til 638 MHz BC: 670 til 694 MHz C: 766 til 790 MHz D: 794 til 806 MHz E: 821 til 832 MHz og 863 til 865 MHz K: 925 til 937,5 MHz
Koblingsbåndbredde	Op til 24 MHz
Frekvenser	8 kanalrækker hver med op til 10 forindstillede kanaler
Signal-støj-afstand	≥ 103 dBA
Klirfaktor	≤ 0,9 %
Temperaturområde	Under drift: 0 °C til +40 °C Opbevaring: -20 °C til +70 °C
Sender-synkronisering	2,4 GHz, RF Power <3 mW, Low Power OQPSK (kun aktiv under synkronisering)

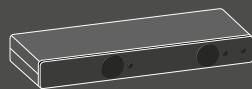

Modtager

	EM-XSW1	EM-XSW1 DUAL
Modtagerprincip	Double-superheterodyn	
Diversity princip	Antenna Switching Diversity via interne antenner	
Følsomhed (ved maks. slaglængde)	< 3 μ V ved 52 dB(A) _{eff} S/N	
Audio-sendeområde	50 til 16 000 Hz (-3 dB)	
Maks. audio-udgangsspænding (ved maks. slaglængde, 1 kHz NF)	6,3 mm-jackstik (usymmetrisk): +6 dBu XLR-bøsning (symmetrisk): +12 dBu	
Audio-indstillingsområde	45 dB, kan indstilles i trin på 5 dB	
Spændingsforsyning	12 V _{DC} nom./300 mA	12 V _{DC} nom./500 mA
Støjspærre (squellch)	Kan indstilles fra 3 dB μ V til 28 dB μ V (kombineret med pilottone)	
Line-/mic-niveau	20 dB kan omstilles	
Husmateriale	Robust ABS-hus	
Dimensioner (B x H x D)	Ca. 200 x 42 x 127 mm	Ca. 320 x 42 x 127 mm
Vægt	Ca. 340 g	Ca. 610 g

Sender

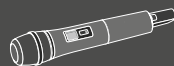

SK-XSW

SKM-XSW

e 825

e 835

HF-udgangseffekt	10 mW	
Audio-sendeområde	50 til 16 000 Hz (line) 80 til 16 000 Hz (mic)	80 til 14000 Hz 80 til 16000 Hz
Audio-indgang	3,5 mm-jackstik	–
Maks. indgangsspænding (mic/line) ved 3 % klirfaktor	Typ. 1,5 V _{RMS} mic/ typ. 2,6 V _{RMS} line @ -30 dB gain	–
Spændingsforsyning	2 batterier, type AA, 1,5 V	2 batterier, type AA, 1,5 V
Funktionstid	Ca. 10 timer	
Mikrofontype	–	Dynamisk
Indgangsfølsomhed kapsel	–	1,5 mV/Pa
Retningskarakteristik	–	Nyre
Indstillingsområde senderfølsomhed	0 til -30 dB, kan indstilles i trin på 10 dB	
Husmateriale	Robust ABS	
Dimensioner	Ca. 71 x 96 x 28 mm (B x H x D)	Ca. 260 x 50 mm (L x Ø)

Mikrofoner

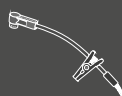
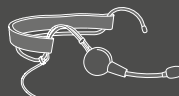

ME 2-2

ME 3-II

e 908T

Omformerprincip	Kondensator, permanent polariseret	Kondensator, permanent polariseret	Kondensator, permanent polariseret
Følsomhed	20 mV/Pa	1,6 mV/Pa	0,6 mV/Pa
Retningskarakteristik	Kugle	Nyre	Nyre
Maks. lydtryksniveau	130 dB	150 dB	147 dB

Netdel NT 12-5CW

Nominel indgangsspænding	100 til 240 V~
Netfrekvens	50 eller 60 Hz
Indgangsstrøm	≤ 200 mA
Nominel udgangsspænding	12 V ⁼⁼
Udgangsstrøm	≤ 500 mA
Stand-by-effektforbrug	≤ 0,075 W @230 V AC ≤ 0,1 W @115 V AC
Energieffektivitetsklasse	DoE Level VI
Temperaturområde	0 °C til +40 °C
Opbevaringstemperatur	-20 °C til +60 °C
Relativ luftfugtighed	Maks. 95 %
Vægt (uden adapter)	Ca. 65 g
Kabellængde	Ca. 1,83 m

Stikkonfiguration

EM-XSW1

6,3 mm-mono-jackstik

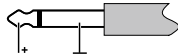

SK-XSW

XLR-3-stik

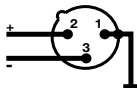

3,5 mm-jackstik





Producenterklæringer

Garanti

Sennheiser electronic GmbH & Co. KG yder 24 måneders garanti på dette produkt. De gældende garantibetingelser findes på internetadressen www.sennheiser.com eller de kan fås hos din Sennheiser-forhandler.

Overensstemmelse med følgende direktiver

- WEEE-direktivet (2012/19/EU) 
- Batteridirektiv (2013/56/EU & 2006/66/EU) 

Henvisninger vedr. bortskaffelse

Symbolet med den overstregede skraldespand på hjul på produktet, batteriet/det genopladelige batteri og/eller emballagen gør opmærksom på, at disse produkter ikke må bortskaffes med det normale husholdningsaffald efter afslutningen af sin levetid men skal bortskaffes separat i overensstemmelse med forskrifterne. Overhold de gældende lovmæssige forskrifter i dit land angående affaldssortering med henblik på emballagerne.

Yderligere informationer om genanvendelse af disse produkter kan fås på kommunekontoret, de kommunale genbrugsstationer eller hos din Sennheiser-partner.

Den separate indsamling af udtjent el- og elektronikudstyr, batterier/genopladelige batterier og emballager har til formål at fremme genanvendelsen og/eller genvindingen og undgå negative følger, f.eks. som følge af potentielt indeholdte skadelige stoffer. Hermed yder du et vigtigt bidrag til at beskytte miljøet og sundheden.

CE-overensstemmelse

- 
- RoHS-direktiv (2011/65/EU)

Hermed erklærer Sennheiser electronic GmbH & Co. KG, at radioudstyrstypen XS WIRELESS 1 (bestående af SKM-XSW, SK-XSW, EM-XSW1, EM-XSW1 DUAL) er i overensstemmelse med direktiv 2014/53/EU.

Erklæringen kan findes på internetadressen www.sennheiser.com/download. Læs de nationalt gældende bestemmelser inden ibrugtagning!

Informationer om godkendelser og certificeringer findes i kapitlet „Compliance“.

Rammebetingelser og begrænsninger for anvendelsen af frekvenser

I dit land gælder der muligvis særlige rammebetingelser og begrænsninger for anvendelsen af frekvenser. Før du anvender produktet, kan du søge efter informationer på følgende adresse: www.sennheiser.com/frequency-information.

Tekniset tiedot

Järjestelmä

Modulaatiotyyppi	Laajakaista-FM
Taajuusalueet	A: 548–572 MHz GB: 606–630 MHz B: 614–638 MHz BC: 670–694 MHz C: 766–790 MHz D: 794–806 MHz E: 821–832 MHz ja 863–865 MHz K: 925–937,5 MHz
Kaistanleveys	Jopa 24 MHz
Taajuudet	8 taajuusaluetta, joista jokaisella jopa 10 esiasetettua kanavaa
Signaali-kohinasuhde	≥ 103 dBA
Särökerroin	≤ 0,9 %
Lämpötila-alue	Käytössä: 0 °C ... +40 °C Säilytys: –20 °C ... +70 °C
Synkronointi lähettimen kanssa	2,4 GHz, RF Power <3 mW, Low Power OQPSK (aktiivinen vain synkronoinnin aikana)

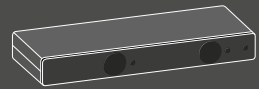

Vastaanotin

	EM-XSW1	EM-XSW1 DUAL
Vastaanottimen periaate	Kaksoissuperheterodyne	
Diversity-periaate	Antenna Switching Diversity sisäisten antennien kautta	
Herkkyys (maksimipoikkeamalla)	< 3 μV arvolla 52 dB(A) _{eff} S/N	
Audiosignaalien taajuusalue	50–16 000 Hz (–3 dB)	
Audiosignaalien maksimilähtöjännite (maksimipoikkeamalla, 1 kHz NF)	6,3 mm:n jakkiliitin (epäsymmetrinen) +6 dBu XLR-liitin (symmetrinen): +12 dBu	
Audion säätöalue	45 dB, säädettävissä 5 dB:n askelin	
Jännitelähde	12 V ^{DC} nim. / 300 mA	12 V ^{DC} nim. / 500 mA
Kohinasalpa (Squelch)	Säädettävissä välillä 3–28 dBμV (pilottiaäneen yhdistettynä)	
Line-/Mic-taso	20 dB vaihdettavissa	
Kotelon materiaali	tukeva ABS-kotelo	
Mitat (L x K x S)	n. 200 x 42 x 127 mm	n. 320 x 42 x 127 mm
Paino	n. 340 g	n. 610 g

Lähetin

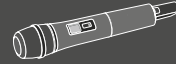

	SK-XSW	SKM-XSW	
		e 825	e 835
HF-lähtöteho		10 mW	
Audiosignaalien taajuusalue	50–16 000 Hz (Line) 80–16 000 Hz (Mic)	80–14000 Hz	80–16000 Hz
Audiotulo	3,5 mm:n jakkiliitin	–	
Maksimitulojännite (Mic/Line), kun särökerroin on 3 %	tyyp. 1,5 V _{RMS} Mic/ tyyp. 2,6 V _{RMS} Line @ –30 dB Gain	–	
Jännitelähde	2 AA-paristoa, 1,5 V	2 AA-paristoa, 1,5 V	
Toiminta-aika	n. 10 tuntia		
Mikrofonityyppi	–	Dynaaminen	
Kapselin tuloherkkyys	–	1,5 mV/Pa	
Suuntakuvio	–	Hertta	
Lähettimen herkkyyden säätöalue	0–30 dB, säädettävissä 10 dB:n askelin		
Kotelon materiaali	tukeva ABS		
Mitat	n. 71 x 96 x 28 mm (L x K x S)	n. 260 x 50 mm (P x Ø)	

Mikrofonit

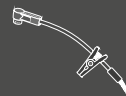
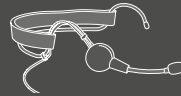

	ME 2-2	ME 3-II	e 908T
Muuntajaperiaate	Kondensaattori, pysyvästi polarisoitu	Kondensaattori, pysyvästi polarisoitu	Kondensaattori, pysyvästi polarisoitu
Herkkyyys	20 mV/Pa	1,6 mV/Pa	0,6 mV/Pa
Suuntakuvio	Kuula	Hertta	Hertta
Maks. äänenpainetaso	130 dB	150 dB	147 dB

Verkkolaite NT 12-5CW

Nimellistulojännite	100–240 V~
Verkkotaajuus	50 tai 60 Hz
Tulovirta	≤ 200 mA
Nimellislähtöjännite	12 V==
Antovirta	≤ 500 mA
Stand-by-tehonotto	≤ 0,075 W @230 V AC ≤ 0,1 W @115 V AC
Energiatohokkuusluokka	DoE Level VI
Lämpötila-alue	0 °C ... +40 °C
Varastointilämpötila	-20 °C ... +60 °C
Suhteellinen ilmankosteus	maks. 95 %
Paino (ilman adapteria)	n. 65 g
Kaapelin pituus	n. 1,83 m

Pistokevaraus

EM-XSW1

6,3 mm:n monojakkiliitin

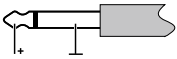

XLR-3-pistoke

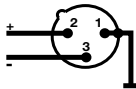

SK-XSW

3,5 mm:n jakkiliitin

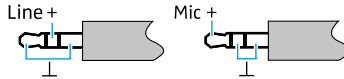



Valmistajan vakuutukset

Takuu

Sennheiser electronic GmbH & Co. KG myöntää tälle tuotteelle 24 kuukauden takuun. Tällä hetkellä voimassa olevat takuehdot voi katsoa internetistä (www.sennheiser.com) tai ne voi pyytää lähimmältä Sennheiser-edustajalta.

Tuote täyttää seuraavien direktiivien vaatimukset

- WEEE-direktiivi (2012/19/EU) 
- Paristodirektiivi (2013/56/EU & 2006/66/EU) 

Ohjeet hävittämiseen

Yliivivattu pyörillä olevan jätetynnyrin tuotteessa, akussa ja/tai pakkauksessa oleva merkki muistuttaa siitä, että näitä tuotteita ei saa hävittää käyttöiän lopussa tavanoimaisten talousjätteiden joukossa, vaan tuote on toimitettava hävitettäväksi sen kaltaisille tuotteille tarkoitettuun keräyspisteeseen. Pakkauksiin liittyen huomioi oman maasi jätteiden lajittelua koskeva lainsäädäntö.

Lisätietoja näiden tuotteiden kierrätyksestä on saatavissa paikallishallinnosta, kunnallisista keräys- tai palautuspisteistä tai lähimmältä Sennheiser-edustajalta.

Erikseen tapahtuvan sähkö- ja elektroniikkalaitteiden, paristojen/akkujen ja pakkausten keräämisen tarkoituksena on edistää toisaalta sähkö- ja elektroniikkaromun uusiokäyttöä niin materiaalien osalta kuin muissakin muodoissa sekä ehkäistä toisaalta tällaisesta romusta aiheutuvat haittavaikutukset, esimerkiksi romun mahdollisesti sisältämien haitallisten aineiden vuoksi. Näin sinulla on tärkeä osa elinympäristön ja terveyden suojelemisessa.

CE-vaatimustenmukaisuus

- 
- RoHS-direktiivi (2011/65/EU)

Sennheiser electronic GmbH & Co. KG vakuuttaa, että radiolaitetyyppi XS WIRELESS 1 (koostuen seuraavista osista: SKM-XSW, SK-XSW, EM-XSW1, EM-XSW1 DUAL) on direktiivin 2014/53/EU mukainen.

Lisätietoja saa internetosoitteesta www.sennheiser.com/download.

Tietoja hyväksynnöistä ja sertifiointeista on luvussa "Compliance".

Taajuusalueiden käyttöä koskevia rajoituksia

Taajuuksien käytölle on saatettu asettaa maassasi erityisiä rajoituksia. Ota selvää rajoituksista ennen tuotteen käyttöönottoa osoitteessa: www.sennheiser.com/frequency-information

Τεχνικά χαρακτηριστικά

Σύστημα

Τύπος διαμόρφωσης	Ευρεία ζώνη-FM
Περιοχές συχνοτήτων	A: 548 έως 572 MHz GB: 606 έως 630 MHz B: 614 έως 638 MHz BC: 670 έως 694 MHz C: 766 έως 790 MHz D: 794 έως 806 MHz E: 821 έως 832 MHz και 863 έως 865 MHz K: 925 έως 937,5 MHz
Εύρος ζώνης μεταγωγής	Έως 24 MHz
Συχνότητες	8 τράπεζες καναλιών με έως 10 προεπιλεγμένα κανάλια η καθεμία
Αναλογία σήματος προς θόρυβο	≥ 103 dBA
Συντελεστής παραμόρφωσης	≤ 0,9 %
Περιοχή θερμοκρασίας	Σε λειτουργία: 0 °C έως +40 °C Αποθήκευση: -20 °C έως +70 °C
Συγχρονισμός πομπού	2,4 GHz, RF Power <3 mW, Low Power OQPSK (μόνο κατά τη διάρκεια που ο συγχρονισμός είναι ενεργός)

Δέκτης

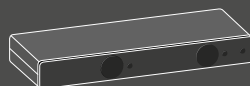

	EM-XSW1	EM-XSW1 DUAL
Αρχή δέκτη	Διπλός υπερετεροδύνατος	
Αρχή διαφορικότητας	Διαφορικότητα μεταγωγής κεραίας μέσω εσωτερικών κεραίων	
Ευαισθησία (σε περίπτωση μέγιστης απόκλισης)	< 3 μV σε 52 dB(A) _{eff} S/N	
Εύρος μετάδοσης ήχου	50 έως 16000 Hz (-3 dB)	
Μέγ. τάση εξόδου ήχου (σε περίπτωση μέγιστης απόκλισης, 1 kHz NF)	1σίο βύσμα 6,3 mm (ασύμμετρο): +6 dBu Βύσμα XLR (συμμετρικό): +12 dBu	
Εύρος ρύθμισης ήχου	45 dB, ρυθμιζόμενο σε βήματα των 5 dB	
Παροχή τάσης	12 V [≐] ονομαστική / 300 mA	12 V [≐] ονομαστική / 500 mA
Κύκλωμα φίμωσης (squelch)	Ρυθμιζόμενο από 3 dBμV έως 28 dBμV (σε συνδυασμό με τόνο πιλότου)	
Στάθμη Line/Mic	20 dB αναλλασσόμενη	
Υλικό περιβλήματος	ανθεκτικό περιβλήμα ABS	
Διαστάσεις (Π x Υ x Β)	περίπου 200 x 42 x 127 mm	περίπου 320 x 42 x 127 mm
Βάρος	περίπου 340 g	περίπου 610 g

Πομπός

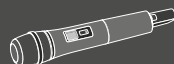

	SK-XSW	SKM-XSW	
		e 825	e 835
Ισχύς εξόδου υψηλής συχνότητας (HF)	10 mW		
Εύρος μετάδοσης ήχου	50 έως 16000 Hz (Line) 80 έως 16000 Hz (Mic)	80 έως 14000 Hz	80 έως 16000 Hz
Είσοδος ήχου	Ίσιο βύσμα 3,5 mm (ασύμμετρο)	–	
Μέγ. τάση εισόδου (Mic/Line) σε συντελεστή παραμόρφωσης 3 %	τυπ. 1,5 V _{RMS} Mic/ τυπ. 2,6 V _{RMS} Line @ –30 dB απολαβή	–	
Παροχή τάσης	2 μπαταρίες, τύπου AA, 1,5 V	2 μπαταρίες, τύπου AA, 1,5 V	
Χρόνος λειτουργίας	περίπου 10 ώρες		
Τύπος μικροφώνου	–	Δυναμικό	
Ευαισθησία εισόδου κάψας	–	1,5 mV/Pa	
Διάγραμμα κατευθυντικότητας	–	Καρδιοειδές	
Εύρος ρύθμισης ευαισθησίας πομπού	0 έως –30 dB ρυθμιζόμενο σε βήματα των 10 dB		
Υλικό περιβλήματος	ανθεκτικό ABS		
Διαστάσεις	περίπου 71 x 96 x 28 mm (Π x Υ x Β)	περίπου 260 x 50 mm (Μ x Ø)	

Μικρόφωνο

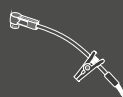
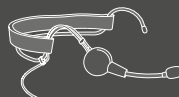

	ME 2-2	ME 3-II	e 908T
Αρχή μετατροπής	Πυκνωτής, συνεχής πόλωση	Πυκνωτής, συνεχής πόλωση	Πυκνωτής, συνεχής πόλωση
Ευαισθησία	20 mV/Pa	1,6 mV/Pa	0,6 mV/Pa
Διάγραμμα κατευθυντικότητας	Σφαιρικό	Καρδιοειδές	Καρδιοειδές
Μέγιστη στάθμη πίεσης ήχου	130 dB	150 dB	147 dB

Τροφοδοτικό NT 12-5CW

Όνομαστική τάση εισόδου	100 έως 240 V~
Συχνότητα ηλεκτρικού δικτύου	50 ή 60 Hz
Ρεύμα εισόδου	≤ 200 mA
Όνομαστική τάση εξόδου	12 V $\overline{-}$
Ρεύμα εξόδου	≤ 500 mA
Κατανάλωση ισχύος σε αναμονή	≤ 0,075 W @230 V AC ≤ 0,1 W @115 V AC
Κατηγορία ενεργειακής απόδοσης	DoE Level VI
Περιοχή θερμοκρασίας	0 °C έως +40 °C
Θερμοκρασία αποθήκευσης	-20 °C έως +60 °C
Σχετική υγρασία αέρα	μέγ. 95 %
Βάρος (χωρίς προσαρμογέα)	περίπου 65 g
Μήκος καλωδίου	περίπου 1,83 m

Αντιστοίχιση επαφών βύσματος

EM-XSW1

Μονοφωνικό ίσιο αρσενικό
βύσμα 6,3 mm

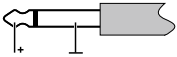

Βύσμα XLR-3

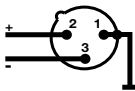

SK-XSW

Μονοφωνικό ίσιο αρσενικό
βύσμα 3,5 mm

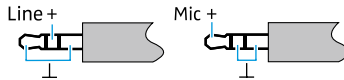



Δηλώσεις κατασκευαστή

Εγγύηση

Η εταιρεία Sennheiser electronic GmbH & Co. KG παρέχει για αυτήν τη συσκευή εγγύηση για 24 μήνες. Τους τρέχοντες έγκυρους όρους εγγύησης μπορείτε να τους βρείτε στο διαδίκτυο στη διεύθυνση www.sennheiser.com ή στην αντιπροσωπεία της Sennheiser.

Σε συμφωνία με τις παρακάτω απαιτήσεις

- Ευρωπαϊκή οδηγία ΑΗΗΕ (2012/19/ΕΕ) 
- Ευρωπαϊκή οδηγία για μπαταρίες (2013/56/ΕΕ & 2006/66/ΕΕ) 

Υποδείξεις για την απόρριψη

Το σύμβολο του διαγραμμένου τροχοφόρου κάδου απορριμμάτων στο προϊόν, την μπαταρία ή/και τη συσκευασία υποδεικνύει ότι αυτά τα προϊόντα δεν πρέπει να απορρίπτονται στα οικιακά απορρίμματα στο τέλος της διάρκειας ζωής τους, αλλά σε ξεχωριστό σύστημα συλλογής απορριμμάτων. Για τις συσκευασίες τηρήστε τις νομοθετικές διατάξεις για τη διαλογή απορριμμάτων που ισχύουν στη χώρα σας.

Για περισσότερες πληροφορίες σχετικά με την ανακύκλωση αυτών των προϊόντων, απευθυνθείτε στο δήμο σας, το δημόσιο σημείο συλλογής ή απόρριψης ή στην αντιπροσωπεία της Sennheiser.

Η ξεχωριστή συλλογή των αποβλήτων ηλεκτρικού και ηλεκτρονικού εξοπλισμού, των μπαταριών και των συσκευασιών συμβάλλει στη προώθηση της επαναχρησιμοποίησης ή/και της ανακύκλωσης και στην αποτροπή των αρνητικών συνεπειών εξαιτίας π.χ. της ύπαρξης πιθανών τοξικών ουσιών. Με αυτόν τον τρόπο συμβάλλετε σημαντικά στην προστασία του περιβάλλοντος και της υγείας.

Συμμόρφωση CE

- 
- Ευρωπαϊκή οδηγία RoHS (2011/65/ΕΕ)

Με την παρούσα ο/η Sennheiser electronic GmbH & Co. KG, δηλώνει ότι ο ραδιοεξοπλισμός XS WIRELESS 1 (αποτελείται από SKM-XSW, SK-XSW, EM-XSW1, EM-XSW1 DUAL) πληροί την οδηγία 2014/53/ΕΕ.

Η δήλωση διατίθεται στο διαδίκτυο στη διεύθυνση www.sennheiser.com/download.

Για πληροφορίες σχετικά με εγκρίσεις και πιστοποιήσεις ανατρέξτε στο κεφάλαιο „Compliance“.

Γενικές προϋποθέσεις και περιορισμοί για τη χρήση συχνοτήτων

Στη χώρα σας ενδέχεται να ισχύουν ειδικές προϋποθέσεις και περιορισμοί για τη χρήση συχνοτήτων. Ενημερωθείτε πριν από την έναρξη χρήσης του προϊόντος στην ακόλουθη διεύθυνση: www.sennheiser.com/frequency-information

Технические характеристики

Система

Тип модуляции	Широкополосная ЧМ	
Диапазоны частот	A: 548—572 МГц B: 614—638 МГц C: 766—790 МГц E: 821—832 МГц и 863—865 МГц	GB: 606—630 МГц BC: 670—694 МГц D: 794—806 МГц K: 925—937,5 МГц
Переключаемая РЧ-полоса	До 24 МГц	
Частоты	8 канальных банков с 10 предустановленными каналами в каждом	
Отношение сигнал/шум	≥ 103 дБ (а)	
Коэффициент нелинейных искажений	≤ 0,9 %	
Диапазон температур	Работа: от 0 до +40 °С Хранение: от -20 до +70 °С	
Синхронизация передатчиков	2,4 ГГц, квадратурная фазовая модуляция со смещением, низковольтный источник питания (работает только во время синхронизации)	

Приемник

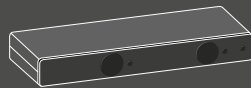

	EM-XSW1	EM-XSW1 DUAL
Принцип приема	Супергетеродинный приемник с двойным преобразованием частоты	
Принцип разнесенного приема	Разнесение антенн с переключением, внутренние антенны	
Чувствительность (при пиковой девиации)	< 3 мкВ при 52 дБ (а) _{эфф.} с/ш	
Диапазон частот передачи аудиосигнала	50—16 000 Гц (-3 дБ)	
Макс. напряжение звукового выхода (при пиковой девиации, 1 кГц НЧ)	Гнездо Jack диаметром 6,3 мм (асимметричное): +6 дБ Штекер XLR (симметричный): +12 дБ	
Диапазон настройки аудиосигнала	45 дБ, настройка с шагом 5 дБ	
Электропитание	12 В ⁻ / 300 мА	12 В ⁻ / 500 мА
Система отключения звукового тракта (Squelch)	Возможность настройки в диапазоне 3—28 дБмкВ (в комбинации с Пилот-тоном)	
Уровень Line/Mic	20 дБ, переключаемый	
Материал корпуса	Прочный корпус из АБС-пластика	
Размеры (Ш x В x Г)	прим. 200 × 42 × 127 мм	прим. 320 × 42 × 127 мм
Вес	прим. 340 г	прим. 610 г

Передатчик

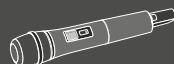

SK-XSW

SKM-XSW

e 825

e 835

Мощность РЧ-выхода	10 мВт		
Диапазон частот передачи аудиосигнала	50—16 000 Гц (Line) 80—16 000 Гц (Mic)	80—14 000 Гц	80—16 000 Гц
Аудиовход	Гнездо Jack диаметром 3,5 мм	—	
Максимальное входное напряжение (Mic/Line) при коэффициенте нелинейных искажений 3 %	тип. 1,5 В _{скз} Mic/ тип. 2,6 В _{скз} Line @ -30 дБ усиление	—	
Электропитание	2 батарейки, типа АА, 1,5 В	2 батарейки, типа АА, 1,5 В	
Время работы	прим. 10 ч		
Тип микрофона	—	Динамический	
Чувствительность входа капсуля	—	1,5 мВ/Па	
Характеристика направленности	—	кардиоидная	
Диапазон настройки чувствительности передатчика	от 0 до -30 дБ с шагом 10 дБ		
Материал корпуса	Прочный АБС-пластик		
Размеры	прим. 71 x 96 x 28 мм (Ш x В x Г)	прим. 260 x 50 мм (Д x Ø)	
Вес	прим. 95 г	прим. 245 г	

Микрофоны

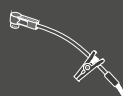
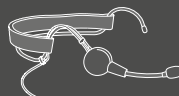

ME 2-2

ME 3-II

e 908T

Принцип преобразования	конденсаторный, поляризованный	конденсаторный, поляризованный	конденсаторный, поляризованный
Чувствительность	20 мВ/Па	1,6 мВ/Па	0,6 мВ/Па
Характеристика направленности	круговая	кардиоидная	кардиоидная
Максимальный уровень звукового давления	130 дБ	150 дБ	147 дБ

Блок питания NT 12-5CW

Номинальное входное напряжение	100—240 В ~
Частота сетевого напряжения	50 или 60 Гц
Входной ток	≤ 200 мА
Номинальное выходное напряжение	12 В ⁼⁼
выходной ток	≤ 500 мА
Потребляемая мощность в режиме ожидания	≤ 0,075 Вт @230 В AC ≤ 0,1 Вт @115 В AC
Класс энергоэффективности	DoE Level VI
Диапазон температур	от 0 до +40 °С
Температура хранения	от -20 до +60 °С
Относительная влажность воздуха	макс. 95 %
Вес (без адаптера)	прим. 65 г
Кабельтов	прим. 1,83 м

Разводка штекеров

EM-XSW1

Штекер типа Jack
моно диаметром 6,3 мм

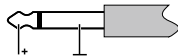

SK-XSW

Штекер XLR-3 Штекер типа Jack
диаметром 3,5 мм

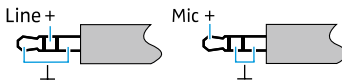
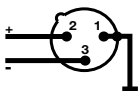



Декларации изготовителя

Гарантия

Компания Sennheiser electronic GmbH & Co. KG предоставляет гарантию на данное изделие сроком 24 месяца. Действующие условия предоставления гарантии можно узнать на сайте www.sennheiser.com или у партнеров Sennheiser.

Соответствие требованиям законодательства

- Директива WEEE (2012/19/EC) 
- Директива по элементам питания (2013/56/EC & 2006/66/EC) 

Указания относительно утилизации

Значок в виде зачеркнутого мусорного контейнера на колесах, приведенный на изделии, батарее/аккумуляторе и/или упаковке, обращает внимание на то, что эти изделия после завершения срока службы нельзя выбрасывать с бытовыми отходами. Такие изделия собираются и утилизируются отдельно. В отношении упаковок соблюдайте предписания законодательства по сортировке отходов, действующие в вашей стране.

Дополнительные сведения об утилизации данных изделий можно получить в муниципальных органах, локальных пунктах сбора и возврата, а также у партнеров Sennheiser в вашем регионе.

Целью раздельного сбора пришедших в негодность электроприборов и электронных устройств, батареек/аккумуляторов и упаковки является поощрение повторного использования материалов и/или их переработки, а также предотвращение отрицательных эффектов, например высвобождения потенциально содержащихся в изделиях опасных веществ. Поддерживая такой порядок, вы делаете важный вклад в сохранение окружающей среды и защиту здоровья окружающих вас людей.

Соответствие стандартам ЕС

- 
- Директива RoHS (2011/65/EC)

Настоящим Sennheiser electronic GmbH & Co. KG заявляет, что радиосистема XS WIRELESS 1 (состоит из SKM-XSW, SK-XSW, EM-XSW1 и EM-XSW1 DUAL) соответствует Директиве 2014/53/EC.

Полный текст заявления приведен на сайте www.sennheiser.com/download.

Информация о допусках и сертификатах приведена в главе «Compliance»..

Общие условия и ограничения использования частот

В вашей стране могут действовать особые условия использования частот и ограничения на этот счет. Перед использованием изделия посетите наш сайт, чтобы узнать больше: www.sennheiser.com/frequency-information.

技术参数

系统

调制方式	宽频FM
频率范围	A: 548至572 MHz GB: 606至630 MHz B: 614至638 MHz BC: 670至694 MHz C: 766至790 MHz D: 794至806 MHz E: 821至832 MHz和863至865 MHz K: 925至937.5 MHz
开关带宽	至24 MHz
频率	8个分别带有最多可达到10个预设频道的频道库
信噪比	≥ 103 dBA
非线性谐波失真系数	≤ 0.9%
温度范围	运行中: 0°C至+40°C 存放: -20°C至+70°C
发射机同步	2.4 GHz, RF Power <3 mW, Low Power QPSK (仅在同步期间激活)

接收器

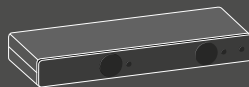

	EM-XSW1	EM-XSW1 DUAL
接收机工作原理	双重超外差	
分集原理	内设天线上的天线交换分集	
灵敏度 (峰值偏差时)	52 dB(A) _{eff} S/N时 < 3 μV	
音频传输范围	50至16 000 Hz (-3 dB)	
最大音频输出电压 (在峰值偏差上, 1 kHz低频)	6.3 mm插孔 (非对称): +6 dBu XLR插孔 (对称): +12 dBu	
音频设置范围	45 dB, 每步可调整	
电源供应	12 V $\overline{=}$ 标称/300 mA	12 V $\overline{=}$ 标称/500 mA
静噪 (Squelch)	从3 dBμV至28 dBμV可调 (结合导频音)	
线路/麦克风电平	20 dB, 可切换	
外壳材料	坚固型ABS外壳	
尺寸 (宽 x 高 x 深)	约200 x 42 x 127 mm	约320 x 42 x 127 mm
重量	约340 g	约610 g

发射机

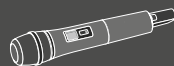

	SKM-XSW	SKM-XSW	
		e 825	e 835
高频输出功率	10 mW		
音频传输范围	50至16000 Hz (线路) 80至16000 Hz (麦克风)	80至14000 Hz	80至16000 Hz
音频输入端	3.5 mm插孔	-	
3%非线性谐波失真系数时的 最大输入电压 (线路/麦克风)	1.5 V _{RMS} Mic型/ 2.6 V _{RMS} Line型 @ -30 dB Gain	-	
电源供应	2枚AA型1.5 V电池	2枚AA型1.5 V电池	
工作时间	约10小时		
麦克风类型	-	动圈式	
话筒头输入信号灵敏度	-	1.5 mV/Pa	
拾音特征	-	心形	
发射机灵敏度设置范围	0至-30 dB, 每步可调整10 dB		
外壳材料	坚固型ABS		
尺寸	约71 x 96 x 28 mm (宽 x 高 x 深)	约260 x 50 mm (长度 x Ø)	
重量	约95 g	约245 g	

麦克风

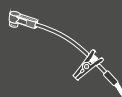
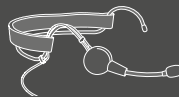

	ME 2-2	ME 3-II	e 908T
换能原理	电容、 驻极体	电容、 驻极体	电容、 驻极体
灵敏度	20 mV/Pa	1.6 mV/Pa	0.6 mV/Pa
拾音特征	全方向	心形	心形
最大声压级	130 dB	150 dB	147 dB

电源适配器NT 12-5CW

额定输入电压	100至240 V~
电源频率	50或60 Hz
输入电流	≤ 200 mA
标称输出电压	12 V $\overline{\overline{=}}$
输出电流	≤ 500 mA
待机功耗	≤ 0,075 W @230 V AC ≤ 0,1 W @115 V AC
节能等级	DoE Level VI
温度范围	0°C 至 +40°C
存放温度	-20°C 至 +60°C
相对空气湿度	最高95%
重量 (不含适配器)	约65 g
电缆长度	约1,83 m

插头配置

EM-XSW1

6.3 mm单声道TRS插头

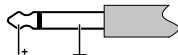

SK-XSW

XLR-3插头

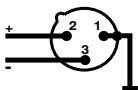

3.5 mm TRS插头





制造商声明

质保

Sennheiser electronic GmbH & Co. KG 公司为本产品承担 24 个月的保修服务。您可以登录公司网站 www.sennheiser.com 或通过 Sennheiser 经销商了解现行的质保条件。

本产品满足以下标准要求：

- WEEE 标准 (2012/19/EU) 
- 电池标准 (2013/56/EU & 2006/66/EU) 

有关废弃处理的提示

在产品、蓄电池/电池和/或包装上有垃圾箱车轮上画了一个叉的标志表示该产品使用寿命到期时不得作为一般生活垃圾进行废弃处理，而需分类收集处理。注意遵守您所在国家对包装垃圾分类的法律规定。

关于产品循环再利用的其它信息请从当地主管部门、城市收集或回收站点或者 Sennheiser 合作商处获取。

分开收集电气电子设备、蓄电池/电池以及包装是为了资源再利用，或者是当地主管部门的要求，同时也是为了避免负面影响，如避免隐含的有害物质。这样，您也为环境保护和健康保护作出了重要贡献。

CE 一致性声明

- 
- RoHS 标准 (2011/65/EU)

Sennheiser electronic GmbH & Co. KG 在此声明，无线电设备型号 XS WIRELESS 1 包括 SKM-XSW、SK-XSW、EM-XSW1 和 EM-XSW1 DUAL，符合标准 2014/53/EU。

您可以在本公司网站 www.sennheiser.com/download 下载此声明。

频率使用的框架条件和限制

您所在的地区对频率使用可能有特殊的框架条件和限制。在调试产品前请访问以下网址获取信息：www.sennheiser.com/frequency-information

China RoHS

部件名称 (Parts) *= 如果包含 (if available)	有害物质						产品环保年限 (EFUP)
	铅 (Pb)	汞 (Hg)	镉 (Cd)	六价铬 (Cr ⁶⁺)	多溴 联苯 (PBB)	多溴二 苯醚 (PBDE)	
金属部件 (Metal Parts)	x	o	o	o	o	o	15
电路模块 (Circuit Modules)	x	o	o	o	o	o	15
电缆及电缆组件 (Cables and Cable Assemblies)	x	o	o	o	o	o	15
电路开关 (Circuit Breakers)*	x	o	o	o	o	o	15
外部电力适配器 (External Power Supply)*	x	o	o	o	o	o	10
电池 (Battery)*	x	o	o	o	o	o	5

本表格依据 SJ/T 11364 的规定编制。

- o: 表示该有害物质在该部件所有均质材料中的含量均在 GB/T 26572规定的限量要求以下。
- x: 表示该有害物质至少在该部件的某一均质材料中的含量超出 GB/T 26572规定的限量要求。

有关许可和认证的信息请参见章节“Compliance”。

DE

EN

FR

IT

ES

PT

NL

PL

SE

DK

FI

GR

RU

ZH

KO

COMPLIANCE

기술 데이터

System

변조 방법	광대역 FM
주파수 범위	A: 548 ~ 572 MHz GB: 606 ~ 630 MHz B: 614 ~ 638 MHz BC: 670 ~ 694 MHz C: 766 ~ 790 MHz D: 794 ~ 806 MHz E: 821 ~ 832 MHz 및 863 ~ 865 MHz K: 925 ~ 937.5 MHz
스위치 대역폭	최대 24 MHz
주파수	각각 최대 10개의 사전 설정된 채널이 있는 8개의 채널 बैं크
신호-잡음 간격	≥ 103 dBA
왜곡률	≤ 0.9%
온도 범위	작동 중: 0°C ~ +40°C 보관: -20°C ~ +70°C
송신기 동기화	2.4 GHz, RF Power < 3 mW, Low Power OQPSK (동기화 작동 중에만 해당)

수신기

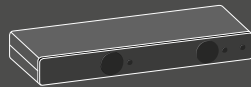

	EM-XSW1	EM-XSW1 DUAL
수신기 유형		더블 슈퍼 헤테로 다인
다이버시티 유형		내부 안테나를 통한 안테나 스위칭 다이버시티
감도 (피크 편차)		< 3 μV, 52 dB(A) _{eff} S/N
오디오 전송 범위		50 ~ 16,000 Hz (-3 dB)
최대 오디오 출력 전압 (피크 편차, 1 kHz NF)		6.5 mm 잭 플러그 (비대칭): +6 dBu XLR 잭 (대칭): +12 dBu
오디오 조정 범위		5 dB 단위로 45 dB 설정 가능
공급 전압	12 V ⁼⁼ 공칭 / 300 mA	12 V ⁼⁼ 공칭 / 500 mA
노이즈 게이트 (스quelch)		3 dBμV 단위로 최대 28 dBμV까지 설정 가능 (파일럿 톤과 조합)
Line/Mic 레벨		20 dB 전환 가능
케이스 소재		견고한 ABS 케이스
치수 (가로 x 세로 x 높이)	약 200 x 42 x 127 mm	약 320 x 42 x 127 mm
중량	약 340 g	약 610 g



송신기

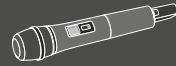

SK-XSW

SKM-XSW

e 825

e 835

HF OUT PUT 출력	10 mW	
오디오 전송 범위	50 ~ 16,000 Hz (Line) 80 ~ 16,000 Hz (Mic)	80 ~ 14,000 Hz 80 ~ 16,000 Hz
오디오 입력	3.5 mm 플러그 잭	-
최대 입력 전압 (Mic/Line), 왜곡율 3%	타입 1.5 V _{RMS} Mic/ 타입 2.6 V _{RMS} Line @ -30 dB Gain	-
공급 전압	2개의 건전지, 타입 AA, 1.5 V	2개의 건전지, 타입 AA, 1.5 V
작동 시간	약 10시간	
마이크 타입	-	동적
입력 감도 캡슐	-	1.5 mV/Pa
방향 특성	-	결절
송신기 감도 조정 범위	0 ~ -30 dB, 10 dB 단위로 설정 가능	
케이스 소재	견고한 ABS	
치수	약 71 x 96 x 28 mm (가로 x 세로 x 높이)	약 260 x 50 mm (L x Ø)
중량	약 95 g	약 245 g

마이크

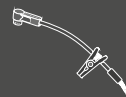
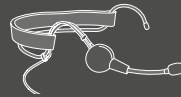

ME 2-2

ME 3-II

e 908T

컨버터 유형	콘덴서, 영구 편향	콘덴서, 영구 편향	콘덴서, 영구 편향
감도	20 mV/Pa	1.6 mV/Pa	0.6 mV/Pa
방향 특성	불	결절	결절
최대 음압 레벨	130 dB	150 dB	147 dB

전원 부품 NT 12-5CW

공칭 입력 전압	100 ~ 240 V-
전원 주파수	50 또는 60 Hz
입력 전류	≤ 200 mA
정격 출력 전압	12 V ^{DC}
출력 전류	≤ 500 mA
대기 전력 소비	≤ 0.075 W @230 V AC ≤ 0.1 W @115 V AC
에너지 효율 등급	DoE Level VI
온도 범위	0°C ~ +45°C
보관 온도	-20°C ~ +60°C
상대 습도	최대 95%
무게 (어댑터 제외)	약 65 g
케이블 길이	약 1.83 m

잭 할당

EM-XSW1

6.3 mm 모노 잭 플러그

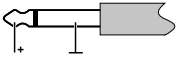

XLR-3 잭

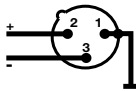

SK-XSW

3.5 mm 잭 플러그

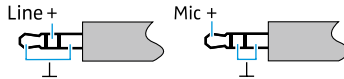

제조사 선언

품질 보증

Sennheiser electronic GmbH & Co. KG는 24개월 동안 이 제품에 대한 품질을 보장합니다. 현재 유효한 보증 조건은 www.sennheiser.com 또는 Sennheiser 상담원을 통해 확인할 수 있습니다.

다음의 요건을 준수합니다.

- WEEE 지침 (2012/19/EU)



- 배터리 지침 (2013/56/EU & 2006/66/EU)



폐기 지침

바퀴 달린 쓰레기통에 엑스 표시된 기호가 있는 제품이나 배터리 또는 포장의 경우, 이 제품 수명이 다했을 때 가정용 쓰레기로 폐기해서는 안 되며 별도의 폐기업체에 전달해야 합니다. 포장재의 경우 해당 국가의 쓰레기 분리 수거 규정에 따라 폐기하십시오.

이 제품의 재활용에 관한 자세한 정보는 구청이나 지역 수거업체 또는 Sennheiser 파트너에 문의하십시오.

전기전자 폐기물이나 배터리 또는 포장의 분리 수거는 재사용 및 재활용 촉진에 도움이 되며 잠재적으로 들어 있는 유해물질 등으로 인한 부정적인 효과를 방지하는 데 도움이 됩니다. 이에 분리 수거를 하면 환경과 인체 보호에 기여를 하는 것입니다.

CE 적합성 선언



- RoHS 지침 (2011/65/EU)

이에 Sennheiser electronic GmbH & Co. KG는 SKM-XSW, SK-XSW, EM-XSW1 및 EM-XSW1 DUAL 으로 구성된 무선기기 모델 XS WIRELESS 1이 2014/53/EU 지침에 부합함을 선언합니다.

이 선언서는 www.sennheiser.com/download에 수록되어 있습니다.

승인 및 인증에 대한 정보는 «Compliance» 장을 참조하십시오.

주파수 사용을 위한 필수 조건과 제한

국가마다 주파수 사용에 대한 별도 조건 및 제한이 있을 수 있습니다. 제품을 처음 사용하기 전에 다음 주소에서 정보를 확인하십시오 www.sennheiser.com/frequency-information.

EM-XSW1



EM-XSW1 DUAL

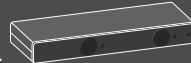

SK-XSW



SKM-XSW

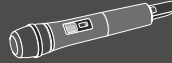

In compliance with

Canada	EM EM DUAL SK SKM		Industry Canada RSS 210
Europe	EM EM DUAL SK SKM		EMC EN 301489-1/-3/-9 Radio EN 300422-2, EN 301440 Safety EN 60065, EN 62311 (SAR), EN 62368-1
USA	EM, EM DUAL SK/SKM		FCC Part 15 FCC Part 74, FCC Part 15

DE

EN

FR

IT

ES

PT

NL

PL

SE

DK

FI

GR

RU









ZH

KO

COMPLIANCE



Certified by

Range A: 548 - 572 MHz







Europe	EM EM DUAL SK SKM		
USA	EM EM DUAL SK SKM	FCC ID: DMOEMXSW1 FCC ID: DMOEMXSW1D FCC ID: DMOSKXSW FCC ID: DMOSKMXSW	
Canada	EM EM DUAL SK SKM	IC: 2099A-EMXSW1 IC: 2099A-EMXSW1D IC: 2099A-SKXSW IC: 2099A-SKMXSW	
Australia/New Zealand	EM EM DUAL SK SKM		
Singapore	EM SK SKM	<div style="border: 1px solid black; padding: 5px; text-align: center;">Complies with IMDA Standards DB100582</div>	
Philippines	EM EM DUAL SK SKM	 NTC	ESD-1714240C ESD-1816607C ESD-1714242C ESD-1714241C
Vietnam	SK SKM		CÔNG TY TNHH GV A1359291216AF04A2 CÔNG TY TNHH GV A1365291216AF04A2
Brazil	EM EM DUAL SK SKM	   	01187-17-07356 01626-18-07356 00995-17-07356 01188-17-07356

Certified by

Range GB: 606 - 630 MHz

Europe	EM EM DUAL SK SKM		
Philippines	EM EM DUAL SK SKM		ESD-1714240C ESD-1816607C ESD-1714242C ESD-1714241C



Range B: 614 - 638 MHz

Europe	EM EM DUAL SK, SKM		
Australia/New Zealand	EM EM DUAL SK, SKM		
Singapore	EM SK SKM	<div style="border: 1px solid black; padding: 5px; display: inline-block;">Complies with IMDA Standards DB100582</div>	
Philippines	EM EM DUAL SK SKM		ESD-1714240C ESD-1816607C ESD-1714242C ESD-1714241C
Brazil	EM		01187-17-07356
	EM DUAL		01626-18-07356
	SK		00995-17-07356
	SKM		01188-17-07356



- DE
- EN
- FR
- IT
- ES
- PT
- NL
- PL
- SE
- DK
- FI
- GR
- RU
- ZH
- KO
- COMPLIANCE

Certified by



Range BC: 670 - 694 MHz

Europe	EM EM DUAL SK, SKM	
Australia/New Zealand	EM EM DUAL SK, SKM	

Range C: 766 - 790 MHz

Europe	EM EM DUAL SK SKM			
China	SK SKM	CMIIT ID: 2016DJ6109 CMIIT ID: 2016DJ6104		
Indonesia	SK SKM	<table border="1" data-bbox="464 646 680 774"> <tr> <td>52103/SDPPI/2017 7004</td> </tr> <tr> <td>52099/SDPPI/2017 7004</td> </tr> </table>	52103/SDPPI/2017 7004	52099/SDPPI/2017 7004
52103/SDPPI/2017 7004				
52099/SDPPI/2017 7004				
Philippines	EM EM DUAL SK SKM	 NTC ESD-1714240C ESD-1816607C ESD-1714242C ESD-1714241C		

Range D: 794 - 806 MHz

Europe	EM EM Dual SK SKM			
Indonesia	SK SKM	<table border="1" data-bbox="464 1050 680 1177"> <tr> <td>52103/SDPPI/2017 7004</td> </tr> <tr> <td>52099/SDPPI/2017 7004</td> </tr> </table>	52103/SDPPI/2017 7004	52099/SDPPI/2017 7004
52103/SDPPI/2017 7004				
52099/SDPPI/2017 7004				
Philippines	EM EM DUAL SK SKM	 NTC ESD-1714240C ESD-1816607C ESD-1714242C ESD-1714241C		
Thailand	EM EM DUAL SK SKM	เครื่องโทรคมนาคมและอุปกรณ์นี้ มีความ สอดคล้องตามข้อกำหนดของ กทช A55001-17 A55034-18 A55003-17 A55002-17		

Certified by

Range E: 821 - 832 and 863 - 865 MHz

Europe	EM EM DUAL SK SKM	
Indonesia	SK	52104/SDPPI/2017 7004
	SKM	52062/SDPPI/2017 7004



Range K: 925 - 937,5 MHz

South Korea	EM EM DUAL SK SKM Remote Module		MSIP-REM-SE9-XSWEM R-REM-SE9-EMXSW1D MSIP-CRM-SE9-XSWSK MSIP-CRM-SE9-XSWSKM MSIP-CRM-WOL-CC2500
-------------	---	---	---

NT 12-5CW



In compliance with

Europe		EMC Safety RoHs Energy efficiency level V Commission Regulation 278/2009 and 1275/2008 (EU) No.	EN 55032, EN 55024 EN 60950-1 EN 50581
USA/Canada		EMC Safety Energy efficiency level	FCC 47 CFR 15 B ICES 003, CAN ICES-3(B)/NMB-3(B) UL 60950-1 CAN/CSA-C22.2 No. 60950-1 DOE Level VI
China		EMC Safety RoHS	GB13837, GB17625 GB4943 
Australia/New Zealand		EMC Safety	AS/NZS CISPR 22 AS/NZS 60950-1

Certified by

Europe



USA/Canada



E310721

Australia/New Zealand



Japan



China



South Korea



MSIP-REM-S8L-5WVI-12-120050

Argentina



Mexico



Taiwan



Russia





Sennheiser electronic GmbH & Co. KG

Am Labor 1, 30900 Wedemark, Germany

www.sennheiser.com

Printed in Taiwan, Publ. 08/18, 571314/A06