

The AT-063AP is a flush-mounted wall attenuator and uses a transformer which allows connection of a wide range of loads (6 W or less). Volume can be adjusted in five steps. The AT-063AP features push-in terminal block for easy connection.



Article number:AT-063AP

Specifications

Finish	ABS resin, white,
Operating temperature	-10 °C to +50 °C

Appearance

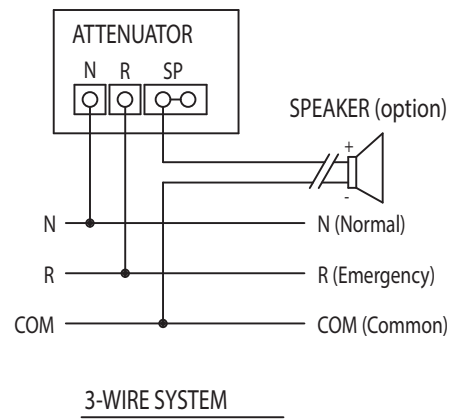
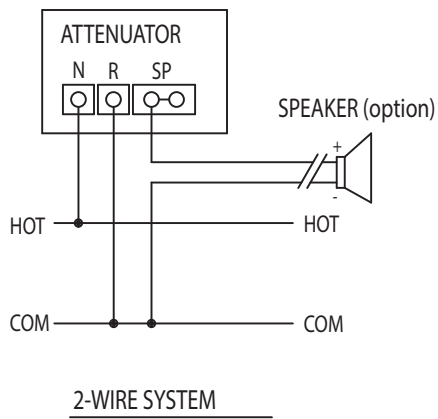
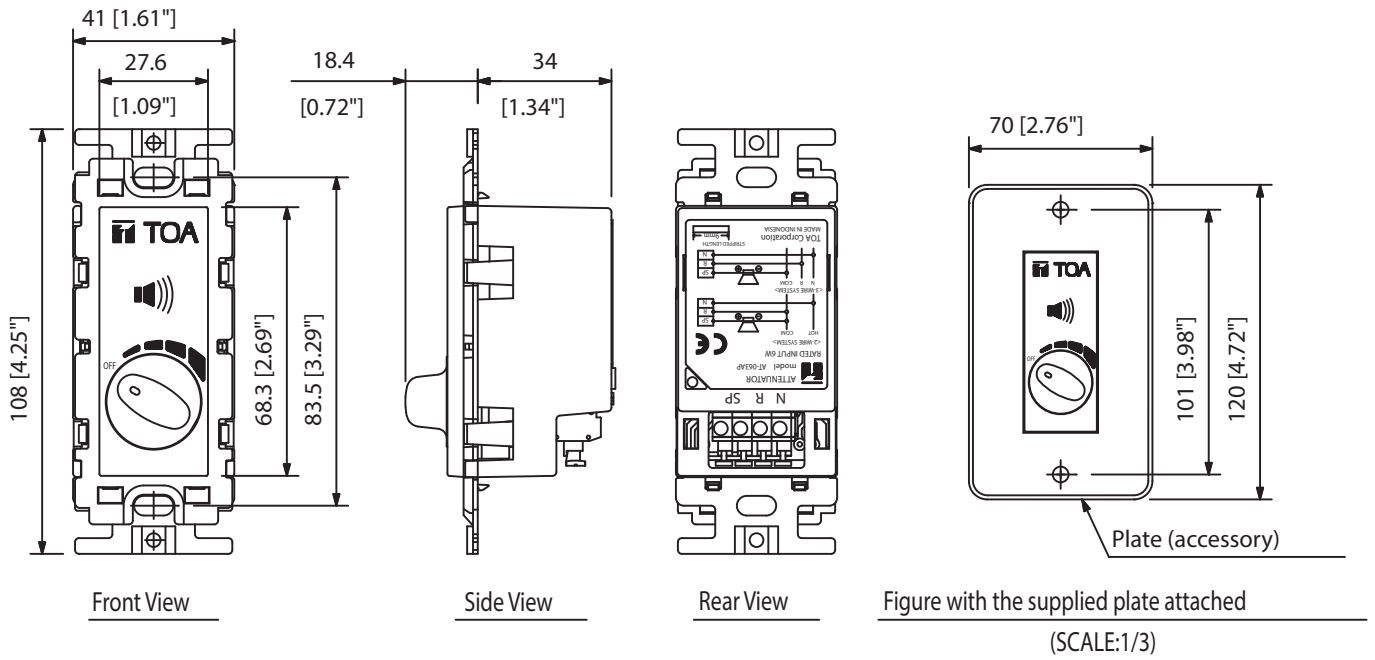

UNIT:mm SCALE:1/2