

DESCRIPTION

The AT-4120 AS is a flush or surface mounting wall attenuator and uses matching transformer which allows connection of speaker loads under 120W. Volume can be adjusted in eight steps. AT-4120 AS is a square type volume control featuring override relay with LED indicator. AT-4120 AS can be connected in 2, 3, or 4 wiring system.

SPECIFICATIONS

Input Capacity	120 Watt
Attenuations	8 steps (0dB, -3dB, -6dB, -9dB, -12dB, -15dB, -18dB, OFF)
Override Indicator	Red LED (4-wire connection only)
Overriding Voltage	24V DC, 11mA (4-wire connection only)
Dimensions	86 (W) x 86 (H) x 51 (D) mm
Weight	0.48 Kg
Color	White (RAL 9016 or equivalent)
Finish	Knob, Cover Panel : ABS Resin, White (RAL 9016 or equivalent) Front Panel (Plate) : Surface treated steel plate
Terminal	Screw type x 5 (Terminals)
Usable Cable	Cable range : 22 - 14 AWG
Accessories	Back Box (85.5 (W) x 85.5 (H) x 60 (D) mm) Plate mounting screw 2

APPEARANCE

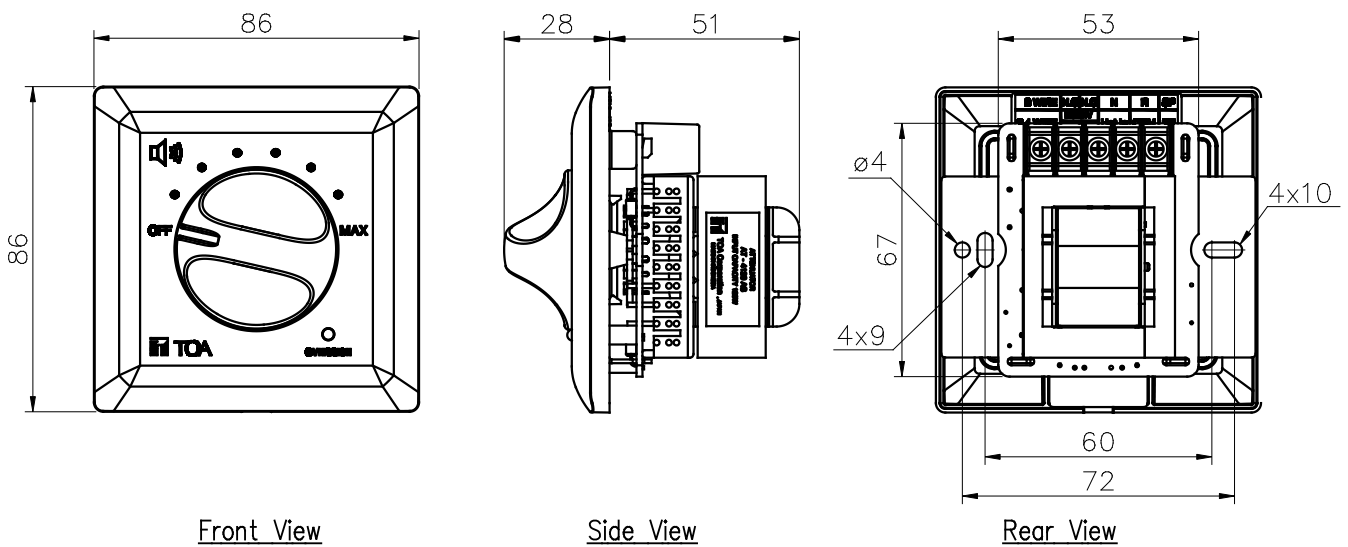

From Output Amplifier

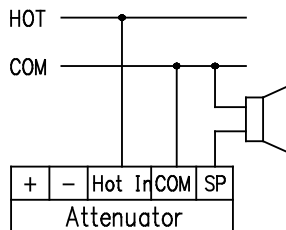

2 - WIRE CONNECTION

From Output Amplifier

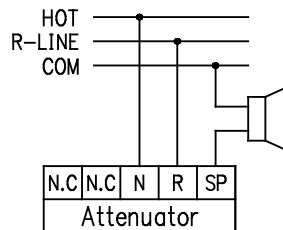

3 - WIRE CONNECTION

From Output Amplifier

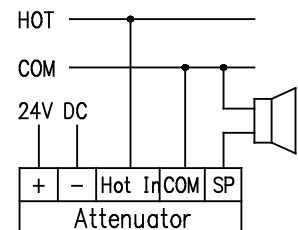

4 - WIRE CONNECTION

Note : N.C is NOT CONNECTED

UNIT : mm SCALE : 1/2

BACK BOX

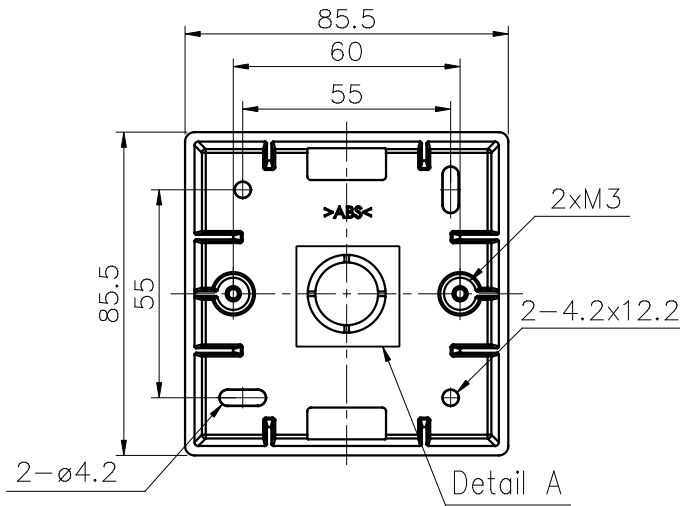

FRONT VIEW

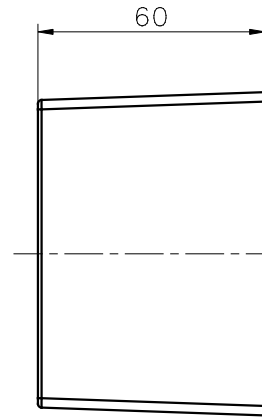

SIDE VIEW

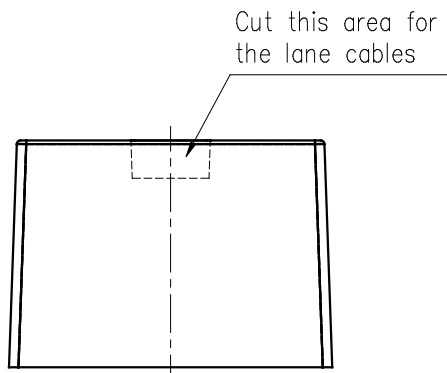

TOP VIEW

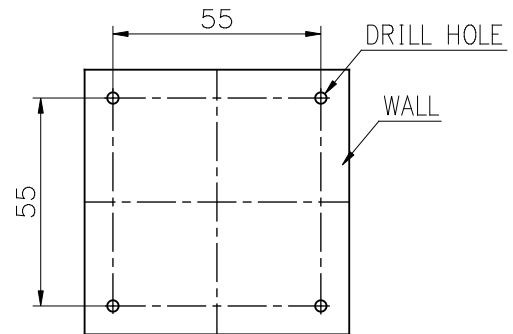

Layout dimension of wall for surface mounting.

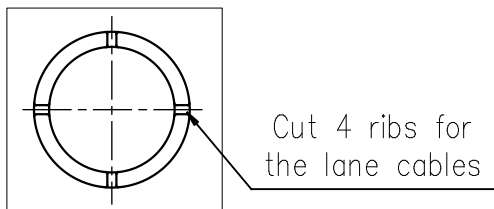

Detail A
SCALE 1:1

Note : Drill hole dimensions depend on wall type.