



INSTRUCTION MANUAL

DIGITAL MIXER

D-901

(Version 3)

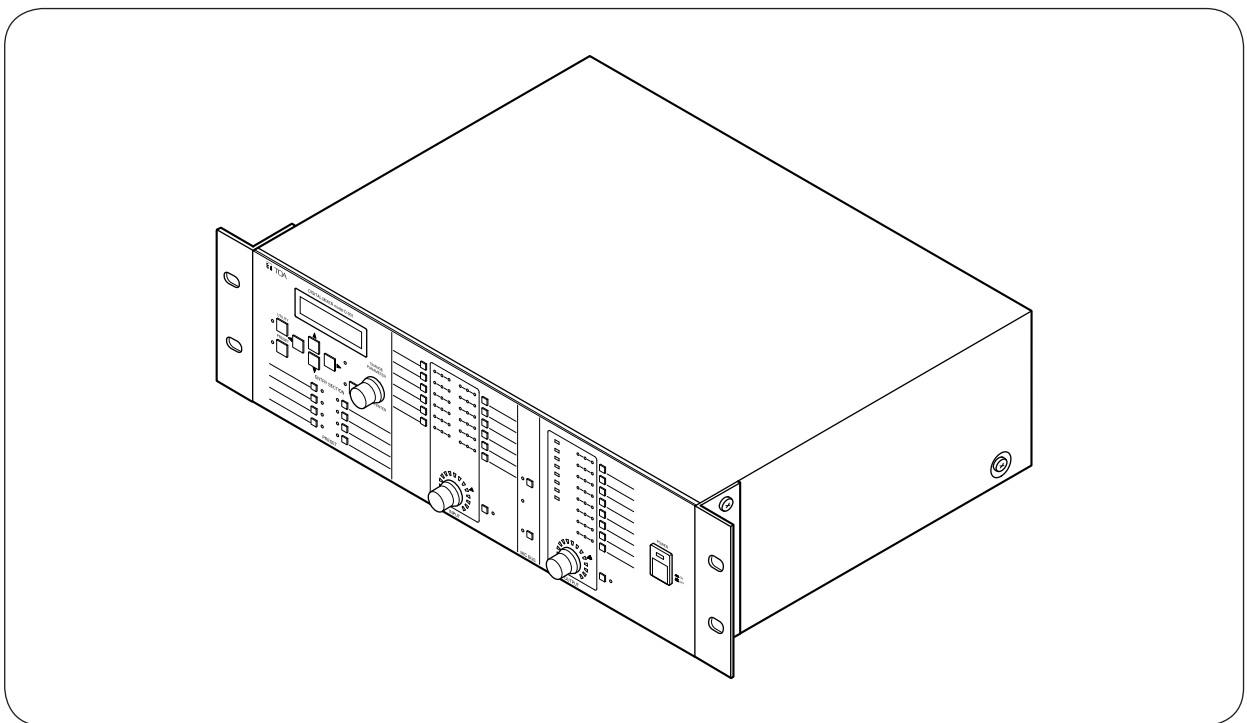

Thank you for purchasing TOA's Digital Mixer.

Please carefully follow the instructions in this manual to ensure long, trouble-free use of your equipment.

Traceability Information for Europe

Manufacturer:
TOA Corporation
7-2-1, Minatojima-Nakamachi, Chuo-ku, Kobe, Hyogo,
Japan

Authorized representative:
TOA Electronics Europe GmbH
Suederstrasse 282, 20537 Hamburg,
Germany

TABLE OF CONTENTS

1. SAFETY PRECAUTIONS	6
2. GENERAL DESCRIPTION	7
3. FEATURES	7
4. HANDLING PRECAUTIONS	7
5. NOMENCLATURE AND FUNCTIONS	
5.1. D-901 Digital Mixer	
Front	8
Rear	11
5.2. Optional Modules	
5.2.1. D-921F Microphone/Line Input Module	12
5.2.2. D-921E Microphone/Line Input Module	12
5.2.3. D-922F Microphone/Line Input Module	13
5.2.4. D-922E Microphone/Line Input Module	13
5.2.5. D-936R Stereo Input Module	13
5.2.6. D-923AE Digital Input Module	14
5.2.7. D-937SP Digital Input Module	14
5.2.8. D-971M Line Output Module	14
5.2.9. D-971E Line Output Module	14
5.2.10. D-971R Line Output Module	15
5.2.11. D-972AE Digital Output Module	15
5.2.12. D-961SP Digital Output Module	15
5.2.13. D-981 Remote Control Module	15
5.2.14. D-983 Remote Control Module	16
5.2.15. D-984VC VCA Control Module	16
6. SETTING BASICS	
6.1. Setting Procedures	17
6.2. Setting Flowcharts	
6.2.1. Input and output settings	18
6.2.2. Microphone bus settings	21
6.2.3. Preset memory settings	21
6.2.4. Utility settings	22
6.3. Setting Keys and Knob	23
6.4. Setting Screen Displays	24
7. INPUT/OUTPUT GAIN SETTINGS	
7.1. Input and Output Channel Control Section Settings	25
7.2. Input/Output Gain Setting Screen Operation	25
7.3. Input/Output Channel Gain Setting Screen Operation	25
8. INPUT-RELATED SETTINGS	
8.1. Phantom Power ON/OFF Settings (Only with D-921E or D-921F module)	26
8.2. PAD (Input Sensitivity) Settings (Only with D-921E or D-921F module)	26
8.3. Line Input Mode Selection (Only with D-936R module)	26
8.4. Channel Status Verification (Only with D-923AE or D-937SP module)	
8.4.1. Input signal status verification	27
8.4.2. Sampling frequency verification	27
8.4.3. Pre-emphasis verification	27
8.5. Line (Stereo) Input Selection (Only with D-936R or D-937SP module)	28
8.6. Input Trim Settings	
8.6.1. Input trim gain settings	28

8.6.2. Input trim polarity settings	28
8.7. High-Pass Filter Settings	
8.7.1. Cutoff frequency settings	29
8.7.2. Q settings	29
8.8. Equalizer Settings	
8.8.1. Gain settings	30
8.8.2. Center frequency settings	30
8.8.3. Q settings	30
8.9. Compressor/Auto-Leveler Mode Selection	31
8.10. Compressor Settings	
(only when the compressor mode is selected in Section 8.9.)	
8.10.1. Threshold level settings	31
8.10.2. Ratio settings	32
8.10.3. Attack time settings	32
8.10.4. Release time settings	32
8.10.5. Makeup gain settings	32
8.11. Auto-Leveler Settings	
(only when the auto-leveler mode is selected in Section 8.9.)	
8.11.1. Target level settings	33
8.11.2. Maximum gain settings	33
8.11.3. Attack time settings	33
8.11.4. Release time settings	34
8.12. Level Sense Settings	
8.12.1. Attack time settings	34
8.12.2. Release time settings	34
8.13. Gate Settings	
8.13.1. Threshold level settings	35
8.13.2. Hysteresis settings	35
8.13.3. Depth settings	35
8.13.4. Hold time settings	35
8.13.5. Attack time settings	35
8.13.6. Release time settings	35
8.14. Auto-Mixing Group Settings	37
8.15. Ducker Settings	
8.15.1. Priority settings	38
8.15.2. Attenuation settings	38
8.15.3. Attack time settings	39
8.15.4. Release time settings	39
8.16. NOM Attenuation ON/OFF Settings	39
8.17. Input Channel Gain Settings	40
8.18. Input Channel Group Trim Gain Settings (Only when Group is set)	40
8.19. Bus Assignment and Crosspoint Gain Settings	
8.19.1. Bus assignment settings	41
8.19.2. Crosspoint gain settings	41

9. OUTPUT SETTINGS

9.1. Output Channel Gain Settings	42
9.2. Output Channel Group Trim Gain Settings (Only when Group is set)	42
9.3. Crossover Settings (Only when Crossover function is enabled)	
9.3.1. Slope settings	43
9.3.2. Cutoff frequency settings	44
9.3.3. Q settings	44
9.3.4. Q2 settings	44
9.3.5. Crossover gain settings	44
9.3.6. Crossover filter polarity settings	44
9.4. Filter Settings	45

9.4.1. Parametric equalizer	47
9.4.2. High-pass filter	47
9.4.3. Low-pass filter	48
9.4.4. High shelving filter	48
9.4.5. Low shelving filter	48
9.4.6. Horn equalizer	49
9.4.7. Notch filter	49
9.4.8. All-pass filter	49
9.5. Compressor Settings	
9.5.1. Threshold level settings	50
9.5.2. Ratio settings	50
9.5.3. Attack time settings	51
9.5.4. Release time settings	51
9.5.5. Makeup gain settings	51
9.6. Delay Time Settings	51

10. MICROPHONE BUS SETTINGS

10.1. Feedback Suppression Settings	
10.1.1. Dynamic mode settings	52
10.1.2. Auto mode activation	53
10.1.3. Filter number settings	53
10.1.4. Dynamic mode filter initialization	53
10.1.5. Auto mode filter initialization	53
10.2. Feedback Suppression Filter Setting Confirmation	
10.2.1. Mode confirmation	54
10.2.2. Frequency confirmation	54
10.2.3. Filter gain confirmation	54
10.2.4. Q confirmation	54
10.3. Effect (Echo) Settings	
10.3.1. Echo gain settings	55
10.3.2. Feedback ratio settings	55
10.3.3. Feedback delay settings	55
10.3.4. Initial echo (pre-) delay settings	56
10.3.5. Low-pass filter frequency settings	56
10.3.6. Low-pass filter Q settings	56
10.4. Bus Assignment and Crosspoint Gain Settings (Microphone Bus → Output Channel)	
10.4.1. Bus assignment settings	56
10.4.2. Crosspoint gain settings	56

11. PRESET MEMORY SETTINGS

11.1. Preset Memory Save	57
11.2. Preset Memory Recall	58
11.3. Preset Memory Delete	58
11.4. Preset Memory Crossfade Time Settings	59
11.5. Initial Preset Memory Selection	60
11.6. Configuration Save	60

12. UTILITY SETTINGS

12.1. Stereo Link Settings	61
12.2. Group Settings	61
12.3. Crossover Configuration Settings	62
12.4. NOM Attenuation Settings	64
12.5. Contact Input/Output Settings (Available only when D-981, D-983 or D-984VC is used)	
12.5.1. Function assignment to the input contact	65

12.5.2. Function assignment to the output contact	67
12.6. Protect Settings	68
12.7. RS-232C Port Settings	
12.7.1. Control mode selection	70
12.7.2. RS-232C transmission rate settings	70
12.8. All Input/Output Channel Gain Confirmation	71
12.9. All Input/Output VCA Status Confirmation (Only when the D-984VC is used)	71
12.10. Module Type Confirmation	
12.10.1. Individual slots confirmation	72
12.10.2. All slots confirmation	73
12.11. Cooling Fan Operating Status Confirmation	73
12.12. Firmware Version Confirmation	73
13. RESTORING FACTORY DEFAULT SETTINGS	74
14. FIRMWARE UPDATE	75
15. RACK MOUNTING	78
16. CONNECTIONS	
16.1. Connection Example 1	79
16.2. Connection Example 2 (Broadcasting to two separate zones)	79
16.3. Removable Terminal Plug Connection	81
16.4. Ferrite Cable Clamp Attachment (For D-972AE only)	81
16.5. Connections of the D-984VC	
16.5.1. Connecting to the D-984VC	82
16.5.2. Input and output channel VCA controls	82
16.5.3. Contact controls	83
17. BLOCK DIAGRAM	84
18. LEVEL DIAGRAMS	
18.1. Analog Input/Output	86
18.2. Digital Input/Output	86
19. PARAMETER SETTING ITEMS AND SETTING RANGES	87
20. SPECIFICATIONS	
20.1. D-901 Digital Mixer	91
20.2. D-921F Microphone/Line Input Module (Optional)	92
20.3. D-921E Microphone/Line Input Module (Optional)	92
20.4. D-922F Microphone/Line Input Module (Optional)	92
20.5. D-922E Microphone/Line Input Module (Optional)	93
20.6. D-936R Stereo Input Module (Optional)	93
20.7. D-923AE Digital Input Module (Optional)	93
20.8. D-937SP Digital Input Module (Optional)	93
20.9. D-971M Line Output Module (Optional)	94
20.10. D-971E Line Output Module (Optional)	94
20.11. D-971R Line Output Module (Optional)	94
20.12. D-972AE Digital Output Module (Optional)	94
20.13. D-961SP Digital Output Module (Optional)	95
20.14. D-981 Remote Control Module (Optional)	95
20.15. D-983 Remote Control Module (Optional)	96
20.16. D-984VC VCA Control Module (Optional)	96

1. SAFETY PRECAUTIONS

- Before installation or use, be sure to carefully read all the instructions in this section for correct and safe operation.
- Be sure to follow all the precautionary instructions in this section, which contain important warnings and/or cautions regarding safety.
- After reading, keep this manual handy for future reference.

Safety Symbol and Message Conventions

Safety symbols and messages described below are used in this manual to prevent bodily injury and property damage which could result from mishandling. Before operating your product, read this manual first and understand the safety symbols and messages so you are thoroughly aware of the potential safety hazards.

WARNING

Indicates a potentially hazardous situation which, if mishandled, could result in death or serious personal injury.

CAUTION

Indicates a potentially hazardous situation which, if mishandled, could result in moderate or minor personal injury, and/or property damage.

When Installing the Unit

- Do not expose the unit to rain or an environment where it may be splashed by water or other liquids, as doing so may result in fire or electric shock.
- Use the unit only with the voltage specified on the unit. Using a voltage higher than that which is specified may result in fire or electric shock.
- Do not cut, kink, otherwise damage nor modify the power supply cord. In addition, avoid using the power cord in close proximity to heaters, and never place heavy objects -- including the unit itself -- on the power cord, as doing so may result in fire or electric shock.

When the Unit is in Use

- Should the following irregularity be found during use, immediately switch off the power, disconnect the power supply plug from the AC outlet and contact your nearest TOA dealer. Make no further attempt to operate the unit in this condition as this may cause fire or electric shock.
 - If you detect smoke or a strange smell coming from the unit.
 - If water or any metallic object gets into the unit
 - If the unit falls, or the unit case breaks
 - If the power supply cord is damaged (exposure of the core, disconnection, etc.)
 - If it is malfunctioning (no tone sounds.)
- To prevent a fire or electric shock, never open nor remove the unit case as there are high voltage components inside the unit. Refer all servicing to your nearest TOA dealer.
- Do not place cups, bowls, or other containers of liquid or metallic objects on top of the unit. If they accidentally spill into the unit, this may cause a fire or electric shock.

When Installing the Unit

- Never plug in nor remove the power supply plug with wet hands, as doing so may cause electric shock.
- When unplugging the power supply cord, be sure to grasp the power supply plug; never pull on the cord itself. Operating the unit with a damaged power supply cord may cause a fire or electric shock.
- Do not block the fan exhaust vent on the unit's rear and the ventilation slots on the bottom. Doing so may cause heat to build up inside the unit and result in fire.
- Avoid installing the unit in humid or dusty locations, in locations exposed to the direct sunlight, near the heaters, or in locations generating sooty smoke or steam as doing otherwise may result in fire or electric shock.
- When installing the unit in an equipment rack, observe the following instructions. Failure to do so may result in fire or personal injury.
 - Install the rack on a solid and stable surface. Then, secure it with anchor bolts or make other appropriate arrangements to prevent it from falling down or moving.
 - Use the screws supplied with the unit to mount on TOA's rack.
 - The AC outlet to which the unit's AC power cable is connected must have allowable current capacity over the unit's current consumption.

When the Unit is in Use

- Switch off the power, and unplug the power supply plug from the AC outlet for safety purposes when cleaning or leaving the unit unused for 10 days or more. Doing otherwise may cause a fire or electric shock.

This device is a Class I product.

Connect the supplied power cord only to the AC outlet with a ground terminal. Doing otherwise may result in electric shock.

2. GENERAL DESCRIPTION

TOA's D-901 is a 19-inch rack-mounted (3U high) digital mixer configured with 12 inputs, 8 buses, and 8 outputs. It features signal processing functions necessary for sound systems such as feedback suppression and auto-mixing. All functional parameters can be set at the unit*. Settings can be stored in the unit's internal memory as "preset memory" and can be recalled using the front panel-mounted operation keys.

* Can also be set at a PC using the setting software, which can be downloaded from our website "<http://www.toa-products.com/international/>".

3. FEATURES

- Acoustic feedback can be suppressed through simple operation.
- Auto-Mixing functions (Ducker*¹ and NOM Attenuation*²) automatically adjust the input signal volume.
- Signals are digitally processed, ensuring high-accuracy sound parameter settings.
- All settings can be performed at the unit using the LCD screen and setting keys and knobs located on the front panel. The settings can also be made at a PC using the dedicated software.
- Modular construction permits flexible configuration of inputs and outputs, from 2-IN/4-OUT to 12-IN/8-OUT systems.
- Up to 16 preset patterns can be stored in memory, which can be easily recalled from either the unit or connected external equipment.
- An RS-232C port permits remote control of the unit using an AMX or Crestron controller, or similar external equipment. The control protocol is available for download at our website <http://www.toa-products.com/international/>.
- A protect function prevents accidental changes of front panel key settings.
- The use of an optional D-981 or D-983 Remote Control Module, or an optional D-984VC VCA Control Module permits easy remote operation of volume control and preset memory recall.
- The use of an optional D-984VC VCA Control Module permits the sound volume to be adjusted from remote locations using the faders or volume controls.

*¹ Automatically adjusts all channel gains in response to input signal level. (Refer to p. 38.)

*² Automatically adjusts the input gain of open microphones corresponding to the number of open microphones in the system. (Refer to p. 39.)

Notes

- AMX is a trademark of AMX Corporation.
- Crestron is a trademark of Crestron Electronics, Inc.

4. HANDLING PRECAUTIONS

- **Warning:** This is a class A product. In a domestic environment this product may cause radio interference in which case the user may be required to take adequate measures.
- **Note:** This equipment has been tested and found to comply with the limits for a Class A digital device, pursuant to part 15 of the FCC Rules. These limits are designed to provide reasonable protection against harmful interference when the equipment is operated in a commercial environment. This equipment generates, uses, and can radiate radio frequency energy and, if not installed and used in accordance with the instruction manual, may cause harmful interference to radio communications. Operation of this equipment in a residential area is likely to cause harmful interference in which case the user will be required to correct the interference at his own expense.
- Use the unit in locations where the temperature is between +5 to +40 °C (no condensation) and the humidity is less than 90%.
- The D-901 is a precision audio component. To prevent failure, avoid locations where the unit may be exposed to strong shocks or vibrations.
- Do not place combustible material under the unit.
- To clean, be sure to first switch off the power, then wipe with a dry cloth. When extremely dirty, use a soft cloth dampened in neutral detergent. Never use benzene, thinner or chemically-treated towels, which may damage the unit's finish.

5. NOMENCLATURE AND FUNCTIONS

5.1. D-901 Digital Mixer

[Front]

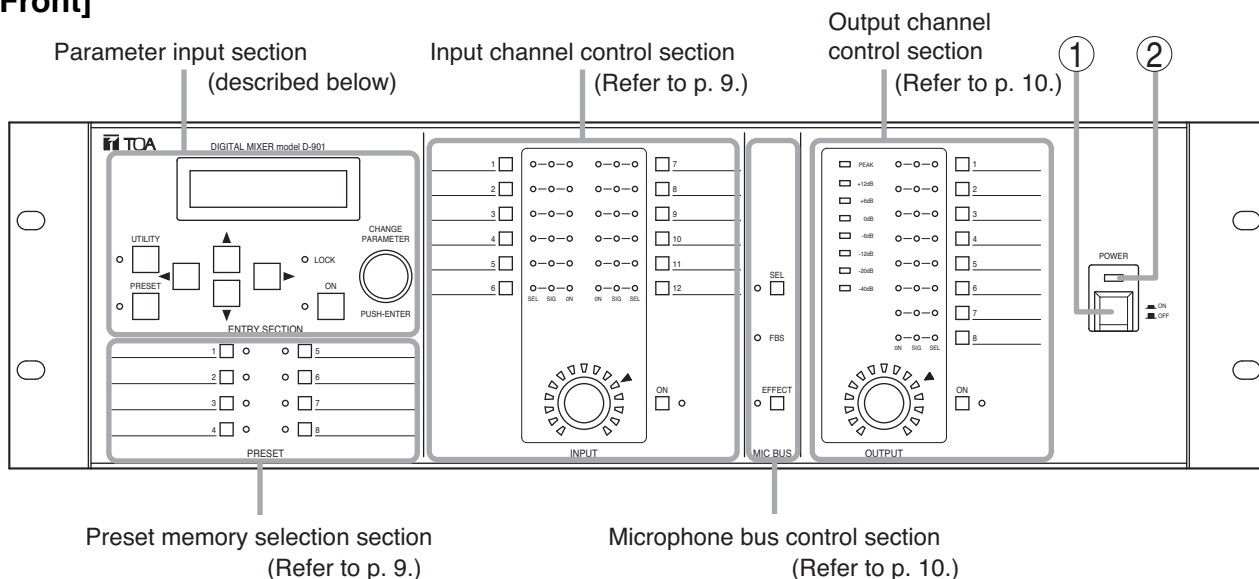

1. Power switch [POWER, ON/ OFF]
 The unit's power switches ON when this switch is pressed, and switches OFF when pressed again.

2. Power Indicator
 Lights when the power is switched ON.

Parameter Input Section

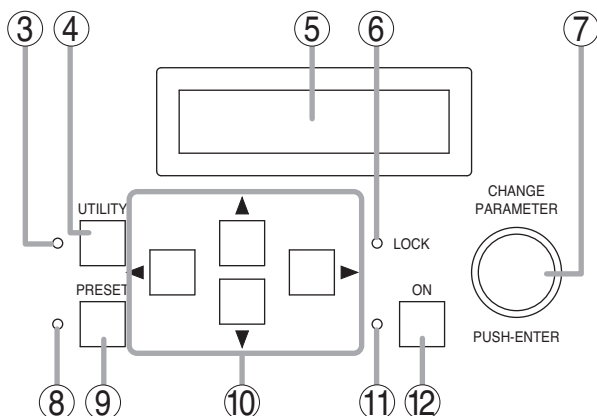

3. Utility Indicator
 Remains lit during selection of the utility function.

4. Utility Key [UTILITY]
 Selects the utility function. Pressing this key displays the utility function setting screen on the LCD screen (5). (Refer to p. 61.)

5. LCD Screen
 When the function key is pressed, its corresponding setting screen is displayed on this screen. If the unit's internal cooling fan malfunctions, the "ERROR" indication appears on the screen even during setting operation. In this case, contact your TOA dealer.

6. System Lock Indicator [LOCK]
 Lights when the protect function is enabled. (For more information on the protect function, refer to

p. 68.)
 Flashes when the D-901 is communicating with a PC.

7. Setting Knob [CHANGE PARAMETER, PUSH-ENTER]
 This knob can be rotated to change parameters or select setting contents, and also operates as a push switch. Pressing the knob when the [OK?] indication is displayed on the LCD screen (5) enables the corresponding function.

8. Preset Indicator
 Remains lit during preset memory selection.

9. Preset Key [PRESET]
 Recalls the settings stored in preset memory or saves the current parameters. The preset memory setting screen appears on the LCD screen (5) when this key is pressed. (Refer to p. 59.)

10. Screen Shift Keys []
 Pressing these keys change the setting items on the LCD screen (5).

11. Function ON/OFF Indicator
 Lights when the parameter shown on the LCD screen (5) is enabled (ON).

12. Function ON/OFF Key [ON]
 Parameters displayed on the LCD screen (5) are enabled (ON) when this key is pressed, and disabled (OFF) when pressed again.

Preset Memory Selection Section

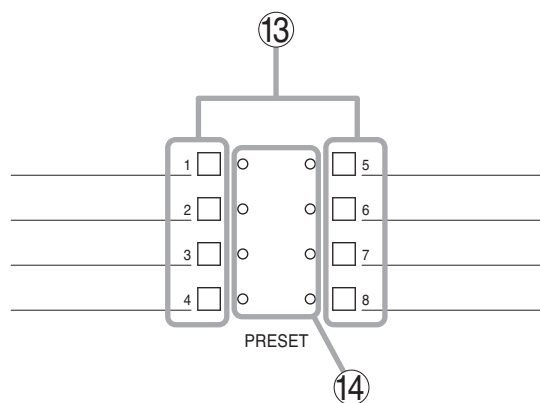

13. Preset Memory Selector Keys [1 – 8]

Recall preset memory patterns 1 – 8. To recall, press the desired Preset Memory Selector key, then press the Setting knob (7).

14. Preset Memory Indicators

The LED corresponding to the currently selected Preset Memory Selection key is illuminated.

Input Channel Control Section

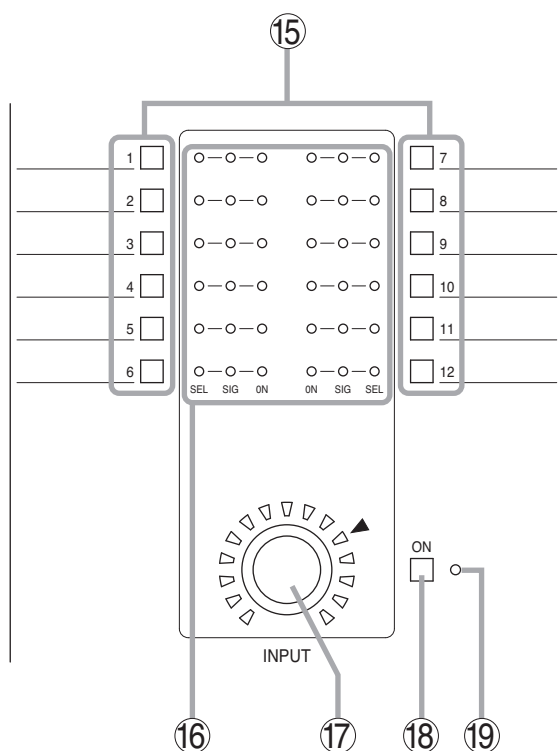

15. Input Channel Selector Keys [1 – 12]

Used to select the input channel for sound volume adjustment or parameter setting. The Input channel indicator [SEL] (16) lights when a key is pressed, causing the corresponding channel number to be displayed on the setting screen.

16. Input Channel Indicators [SEL, SIG, ON]

- SEL: Lights when the input channel is selected.
- SIG

Indicates the input signal level in two colors (red and green). The status of indicator shows as follows depending on the input signal levels.

Red: Signal level is 17 dB or more above the rated input signal level.

Green: Signal level is between -40 dB and $+17$ dB on the basis of the rated input signal level.

OFF: Signal level is lower than -40 dB below the rated input signal level.

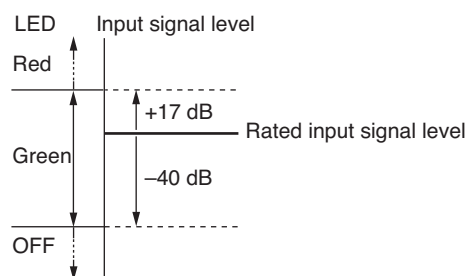

Notes

- The indicator lights red when the signal level is set too high. In such cases, decrease the output level of connected equipment so that the indicator lights green.
- Only when the D-923AE or the D-937SP Digital input module is used, the input channel indicator flashes red if a status error occurs.
- ON: Lights when the channel is selected and active.

17. Input Volume Control [INPUT]

Adjusts the gain of the input channel selected with the Input Channel Selector keys (15).

18. Input Channel ON/OFF Key [ON]

Enables or disables the channel selected with the Input Channel Selector keys (15).

19. Input Channel ON/OFF Indicator

Lights continuously to indicate that the input channel selected with the Input Channel Selector keys (15) is enabled (ON).

Microphone Bus Control Section

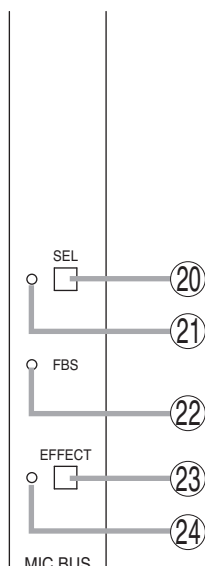

20. Microphone Bus Selector Key [SEL]

Used to set the microphone bus parameters or adjust the volume. Pressing this key causes the

Microphone bus indicator (21) to light, and allows feedback suppression (p. 54), effect (echo) (p. 55), and bus assignment (p. 56) to be set on the LCD screen.

21. Microphone Bus Indicator

Remains lit while the microphone bus is selected.

22. Feedback Suppression Indicator [FBS]

Remains lit while the feedback suppression function is enabled.

23. Effect Key [EFFECT]

The effect (echo) function is enabled when this key is pressed, and the effect (echo) parameters are displayed on the LCD screen, allowing settings to be changed. Pressing the key again disables the effect (echo) function. (Refer to p. 55.)

24. Effect Indicator

Remains lit while the effect (echo) function is enabled.

Output Channel Control Section

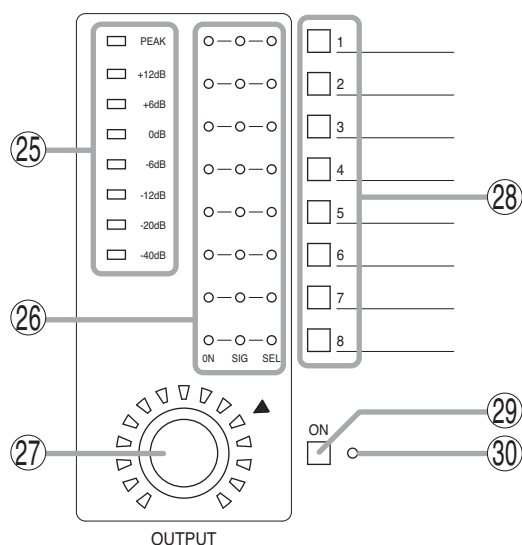

25. Output Signal Level Meter

Indicates the signal level of the channel selected with the Output Channel Selector keys (28).

26. Output Channel Indicators [ON, SIG, SEL]

- ON: Lights when the channel is active.
- SIG

Indicates the output signal level in two colors (red and green). The status of indicator shows as follows depending on the output signal levels.

- Red: Signal level is 17 dB or more above the rated output signal level.
- Green: Signal level is between -40 dB and +17 dB on the basis of the rated output signal level.
- OFF: Signal level is lower than -40 dB below the rated output signal level.

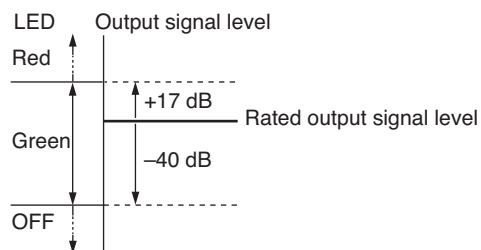

Note

The indicator lights red when the signal level is set too high. In such cases, attenuate the unit's output level so that the indicator lights green.

- SEL: Lights when the output channel is selected.

27. Output Volume Control [OUTPUT]

Adjusts the gain of the output channel selected with the Output Channel Selector keys (28).

28. Output Channel Selector Keys [1 – 8]

Used to select the output channel for sound volume adjustment, parameter setting or Level meter indication (25). The Output Channel indicator [SEL] (26) lights when the key is pressed, permitting parameter setting, volume adjustment with the Output volume control (27) or Level meter (25) signal level indication.

29. Output Channel ON/OFF Key [ON]

Enables or disables the channel selected with the Output Channel Selector keys (28).

30. Output Channel ON/OFF Indicator

Lights continuously to indicate that the output channel selected with the Output Channel Selector keys (28) is enabled (ON).

[Rear]

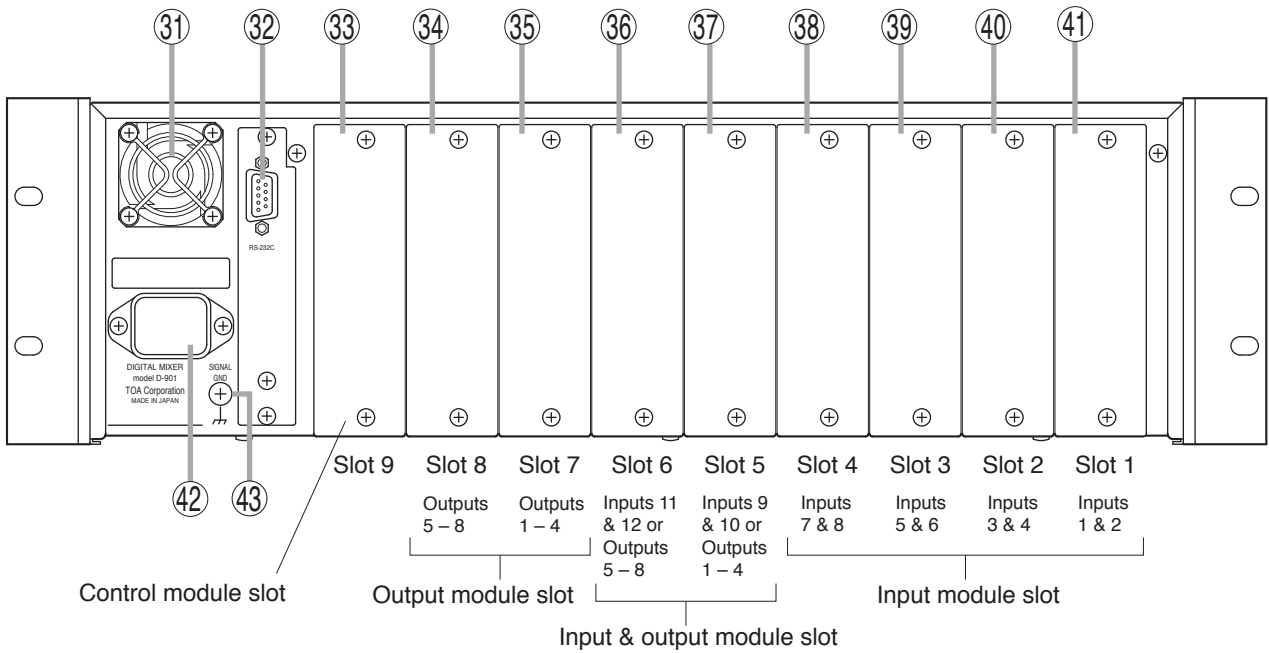

31. Cooling Fan

⚠ CAUTION

Do not block the fan exhaust vent. Doing so may cause heat to build up inside the unit and result in fire.

32. RS-232C Communication Port

A communications connector for a personal computer (PC) or other control equipment.

33. Control Module Slot

The control module's dedicated slot.

34. Output Module Slot

Slot for output channels 5 – 8.

35. Output Module Slot

Slot for output channels 1 – 4.

36. Input/Output Module Slot

Slot for input channels 11 and 12. Inserting an output module here provides output signals for channels 5 – 8.

37. Input/Output Module Slot

Slot for input channels 9 and 10. Inserting an output module here provides output signals for channels 1 – 4.

38. Input Module Slot

Slot for input channels 7 and 8.

39. Input Module Slot

Slot for input channels 5 and 6.

40. Input Module Slot

Slot for input channels 3 and 4.

41. Input Module Slot

Slot for input channels 1 and 2.

42. AC Inlet

Connect this inlet to the wall AC outlet using the supplied power cord.

43. Functional ground terminal

Hum noise may be generated when external equipment is connected to the unit. Connecting this terminal to the functional ground terminal of the external equipment may reduce the hum noise.

Note: This terminal is not for protective ground.

Note

Slots 5 – 8 accommodate only two D-971M and/or D-971E Line Output Modules together or independently in total.

• Explanation of Symbol

Symbol	Explanation
	This symbol stands for a functional ground terminal. When a audio system produces hum noise, then connecting the ground connections between several audio devices may reduce or eliminate it. IMPORTANT NOTE: This is no protective ground!

5.2. Optional Modules

Notes

- Make sure that the power is switched OFF before attaching or detaching modules.
- To avoid failures due to static electricity, do not touch the parts or terminals on the circuit board of both the unit and module.
- Ensure that the module is installed and secured with screws in the correct position.
- Cover idle slots with the blank panels attached to the unit as shipped by the factory.
- Two silver slotted screws at the top and bottom of the front panel are handles used for module detachment. Never rotate them because they do not function as screws.

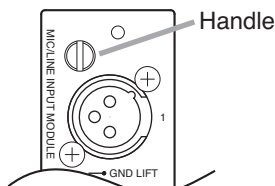

5.2.1. D-921F Microphone/Line Input Module

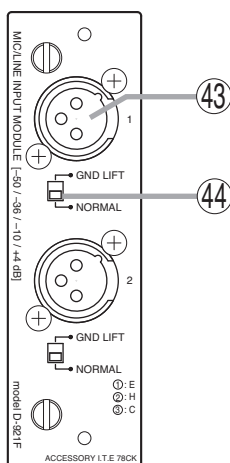

43. Monaural Input Terminal [1, 2] (XLR-3-31 equivalent)

Electronically-balanced input terminal. (Pin 1: Ground; Pin 2: Hot; Pin 3: Cold)
Use XLR-3-12C or equivalent for connection.
Input sensitivity (-50/-36/-10/+4 dB) and phantom power (+15 V) ON/OFF can be set by way of the front panel setting screen.

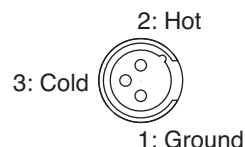

44. Ground Lift Switch [GND LIFT/NORMAL]

Hum noise may be generated due to ground loops created when the unit is connected to other equipment. Setting the switch to the GND LIFT position cuts the ground loop.

5.2.2. D-921E Microphone/Line Input Module

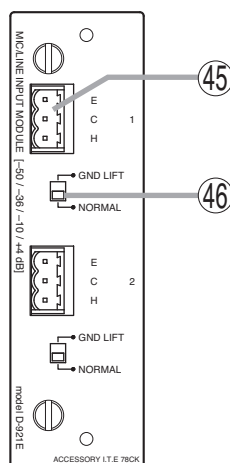

45. Monaural Input Terminal [1, 2]

Electronically-balanced, removable terminal block. (H: Hot; C: Cold; E: Ground)
Input sensitivity (-50/-36/-10/+4 dB) and phantom power (+15 V) ON/OFF can be set by way the front panel setting screen.

46. Ground Lift Switch [GND LIFT/NORMAL]

Hum noise may be generated due to ground loops created when the unit is connected to other equipment. Setting the switch to the GND LIFT position cuts the ground loop.

Note

Be sure to use the supplied removable terminal plugs (3P) for connection.

5.2.3. D-922F Microphone/Line Input Module

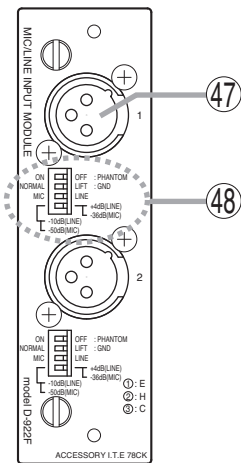

47. Monaural Input Terminal [1, 2] (XLR-3-31 equivalent)

Electronically-balanced input terminal. (Pin 1: Ground; Pin 2: Hot; Pin 3: Cold)
Use XLR-3-12C or equivalent for connection.

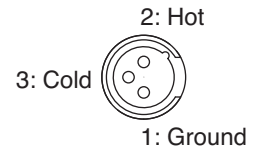

48. Input Sensitivity Switch [PHANTOM, GND LIFT, MIC/LINE]

4-pole switch. Enables phantom power (+15 V; ON/OFF, enabled only when set to the MIC position), ground lift and input sensitivity.
Input sensitivity: -36 or -50 dB (MIC mode) / -10 or +4 dB (LINE mode)

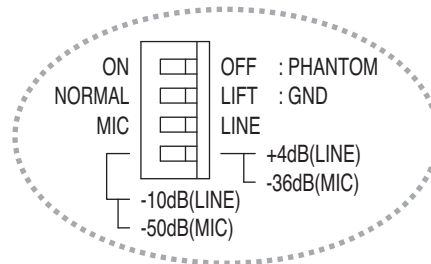

5.2.4. D-922E Microphone/Line Input Module

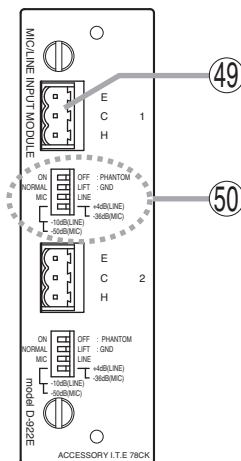

49. Monaural Input Terminal [1, 2]

Electronically-balanced, removable terminal block. (H: Hot; C: Cold; E: Ground)

Note

Be sure to use the supplied removable terminal plugs (3P) for connection.

50. Input Sensitivity Switch [PHANTOM, GND LIFT, MIC/LINE]

4-pole switch. Enables phantom power (+15V; ON/OFF, enabled only when set to the MIC position), ground lift and input sensitivity.
Input sensitivity: -36 or -50 dB (MIC mode) / -10 or +4 dB (LINE mode)

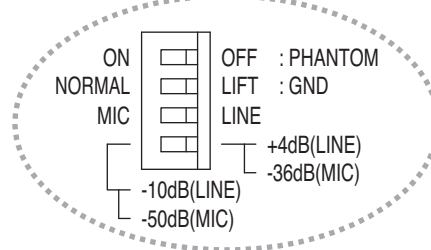

5.2.5. D-936R Stereo Input Module

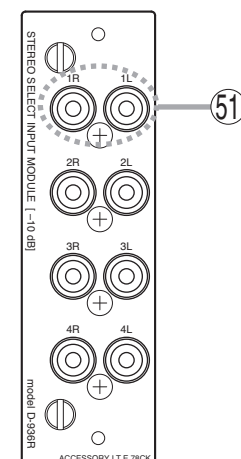

51. Stereo Input Terminal [1L/1R, 2L/2R, 3L/3R, 4L/4R]

Unbalanced, RCA pin jack stereo input terminals. Either a single stereo input can be selected from the 4 available stereo inputs or all 4 stereo channels can be mixed.

Mode setting and stereo selection are performed at the front panel setting screen. They can also be remotely selected by way of connected external equipment through the use of the control module.

Input signal level: -10 dB

5.2.6. D-923AE Digital Input Module

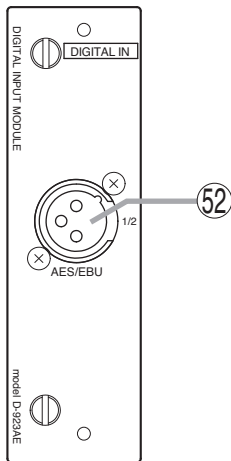

52. AES/EBU Digital Input Terminal [AES/EBU, 1/2] (XLR-3-31 equivalent)
 Digital input terminal of AES/EBU format. (Pin 1: Ground; Pin 2: Signal; Pin 3: Signal)

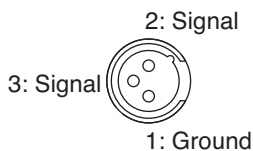

Use the XLR-3-12C or its equivalent for connection.

Note

Use a digital audio cable with characteristic impedance of 110 Ω for connection.

5.2.8. D-971M Line Output Module

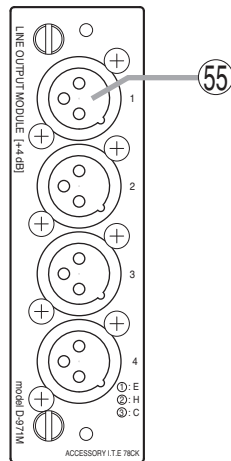

55. Monaural Output Terminal [1, 2, 3, 4] (XLR-3-32 equivalent)
 Electronically-balanced output terminal. (Pin 1: Ground; Pin 2: Hot; Pin 3: Cold)

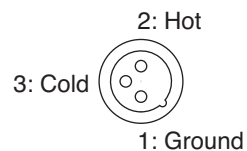

Output signal level: +4dB

Use XLR-3-11C or equivalent for connection.

5.2.7. D-937SP Digital Input Module

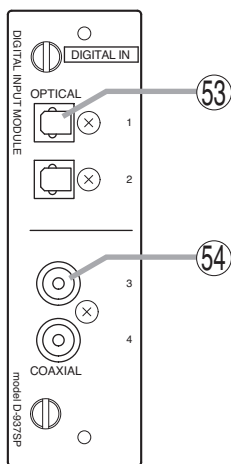

53. Optical Input Terminal [OPTICAL, 1,2]
 Optical input terminal of S/PDIF format.

54. Coaxial Input Terminal [COAXIAL 3, 4]
 Coaxial input terminal of S/PDIF format.

Notes

- Use a coaxial cable with characteristic impedance of 75 Ω for connection.
- One of four line inputs (stereo) is selected. Input selection is performed at the front panel-mounted setting screen.

5.2.9. D-971E Line Output Module

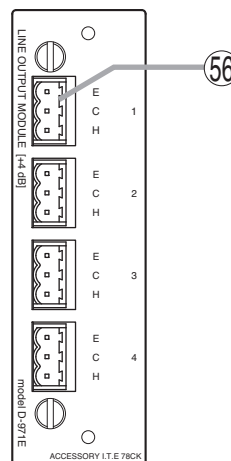

56. Monaural Output Terminal [1, 2, 3, 4]
 Electronically-balanced, removable terminal block. (H: Hot; C: Cold; E: Ground.)
 Output signal level: +4 dB

Note

Be sure to use the supplied removable terminal plugs (3P) for connection.

5.2.10. D-971R Line Output Module

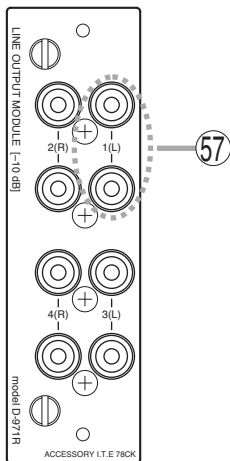

57. Monaural Output Terminals [1(L), 2(R), 3(L), 4(R)]

Unbalanced, RCA pin jack output terminals. Each output is equipped with a 2-channel splitter. Output signal level: -10 dB

5.2.11. D-972AE Digital Output Module

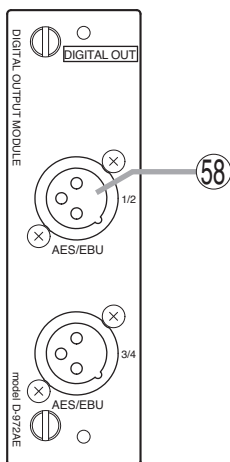

58. AES/EBU Digital Output Terminal [AES/EBU, 1/2] (XLR-3-32 or its equivalent)

Digital output terminal of AES/EBU format. (Pin 1: Ground; Pin 2: Signal; Pin 3: Signal)

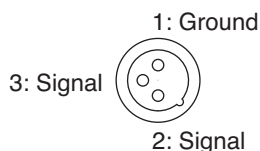

Use the XLR-3-11C or its equivalent for connection.

Note

Use the digital audio cable with characteristic impedance of 110 Ω for connection.

5.2.12. D-961SP Digital Output Module

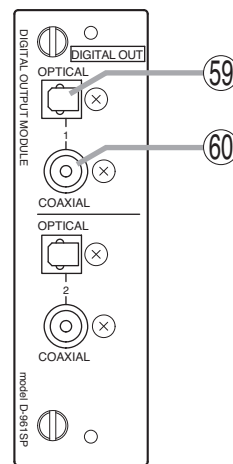

59. Optical Output Terminal [OPTICAL 1, 2]

Optical output terminal of S/PDIF format.

60. Coaxial Output Terminal [COAXIAL 1, 2]

Coaxial input/output terminal of S/PDIF format.

Note

Use a coaxial cable with characteristic impedance of 75 Ω for connection.

Each pair of the S/PDIF optical output and the coaxial RCA pin jack output delivers output in parallel.

5.2.13. D-981 Remote Control Module

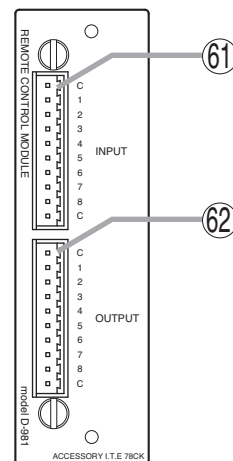

61. Contact Input Terminal [INPUT, C, 1, 2, 3, 4, 5, 6, 7, 8, C]

Removable terminal block, 8-circuit contact input terminal. Individual contact functions are assigned on the front panel setting screen.

Note

Be sure to use the supplied removable terminal plugs (10P) for connection.

62. Contact Output Terminal [OUTPUT, C, 1, 2, 3, 4, 5, 6, 7, 8, C]

Removable terminal block, 8-circuit contact output terminal. Individual contact functions are assigned on the front panel setting screen.

5.2.14. D-983 Remote Control Module

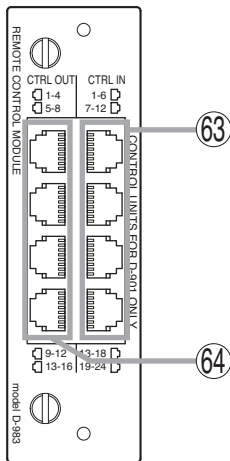

63. Contact Input Terminal [CTRL IN, 1-6, 7-12, 13-18, 19-24]

Six-circuit RJ45 contact input terminals. Assign functions to each contact on the front panel-mounted setting screen.

Pin No.	CTRL IN			
	1-6	7-12	13-18	19-24
1	IN 1	IN 7	IN 13	IN 19
2	IN 2	IN 8	IN 14	IN 20
3	IN 3	IN 9	IN 15	IN 21
4	IN 6	IN 12	IN 18	IN 24
5	IN 5	IN 11	IN 17	IN 23
6	IN 4	IN 10	IN 16	IN 22
7	C	C	C	C
8	C	C	C	C

64. Contact Output Terminal [CTRL OUT, 1-4, 5-8, 9-2, 13-16]

Four-circuit RJ45 contact output terminals. Assign functions to each contact on the front panel-mounted setting screen.

Pin No.	CTRL OUT			
	1-4	5-8	9-12	13-16
1	OUT 1	OUT 5	OUT 9	OUT 13
2	C 1	C 5	C 9	C 13
3	OUT 2	OUT 6	OUT 10	OUT 14
4	C 3	C 7	C 11	C 15
5	OUT 3	OUT 7	OUT 11	OUT 15
6	C 2	C 6	C 10	C 14
7	OUT 4	OUT 8	OUT 12	OUT 16
8	C 4	C 8	C 12	C 16

5.2.15. D-984VC VCA Control Module

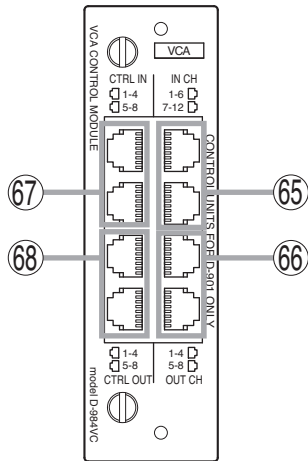

65. Input channel VCA Terminal [IN CH, 1-6, 7-12]

RJ45 VCA terminals. These RJ45 VCA terminals correspond to 12 input channels.

Pin No.	IN CH	
	1-6	7-12
1	IN CH 1	IN CH 7
2	IN CH 2	IN CH 8
3	IN CH 3	IN CH 9
4	IN CH 6	IN CH 12
5	IN CH 5	IN CH 11
6	IN CH 4	IN CH 10
7	V	V
8	C	C

66. Output Channel VCA Terminal [OUT CH, 1-4, 5-8]

RJ45 VCA terminals. These RJ45 VCA terminals correspond to 8 output channels.

Pin No.	OUT CH	
	1-4	5-8
1	OUT CH 1	OUT CH 5
2	OUT CH 2	OUT CH 6
3	OUT CH 3	OUT CH 7
4	C	C
5	V	V
6	OUT CH 4	OUT CH 8
7	V	V
8	C	C

67. Control Input Terminal [CTRL IN, 1-4, 5-8]

RJ45 Control Input terminals. These RJ45 Control Input terminals correspond to 8 control inputs.

Pin No.	CTRL IN	
	1-4	5-8
1	CTRL IN 1	CTRL IN 5
2	C	C
3	CTRL IN 2	CTRL IN 6
4	C	C
5	CTRL IN 3	CTRL IN 7
6	C	C
7	CTRL IN 4	CTRL IN 8
8	V	V

68. Control Output Terminal [CTRL OUT, 1-4, 5-8]

RJ45 Control output terminals. These RJ45 Control output terminals correspond to 8 control outputs.

Pin No.	CTRL OUT	
	1-4	5-8
1	CTRL OUT 1	CTRL OUT 5
2	C 1	C 5
3	CTRL OUT 2	CTRL OUT 6
4	C 3	C 7
5	CTRL OUT 3	CTRL OUT 7
6	C 2	C 6
7	CTRL OUT 4	CTRL OUT 8
8	C 4	C 8

6. SETTING BASICS

6.1. Setting Procedures

The D-901's functions need to be set using the front-mounted keys and knob according to scenes of use. After connecting all external equipment, check the following, then follow the procedures below to set each of the unit's functions.

Check to be sure that

- The required modules are correctly inserted.
- The power supply is correctly connected.
- The power indicator lights when the power switch is turned on.

Step 1. Set which input channel signal is transmitted to which output channel.

Because the factory default setting is made so that each input (1 – 12) is assigned to all outputs (1 – 8) via the Microphone Bus*, when a microphone, or CD player or other music player is connected to an input, its signals are output from all output terminals by simply increasing the corresponding input channel gain. Make input-to-output re-assignment according to scenes of use.

* Refer to p. 84, Block Diagram.

(Refer to p. 41, Bus assignment settings.)

This setting can be performed in either of two ways: On the setting screen display or by way of the front-mounted keys.

Step 2. Set the input sensitivity.

When the D-921E or D-921F is installed, perform this setting by displaying the setting screen. (Refer to p. 26, PAD Settings.)

When the D-922E or D-922F is installed, perform this setting using its DIP switch.

(Refer to p. 12 – 13.)

Set the sensitivity so that the front-mounted Input channel indicator [SIG] does not light red.

Step 3. Set the input channel gain.

(Refer to p. 25, Input/Output Gain Settings.)

This setting can be performed in any of three ways: On the setting screen display (two methods) or by way of the front-mounted keys.

Note: When using the D-984VC VCA Control Module, perform gain settings as well for the input channel to be remotely controlled.

Step 4. Set the output channel gain.

(Refer to p. 25, Input/Output Gain Settings.)

This setting can be performed in any of three ways: On the setting screen display (two methods) or by way of the front-mounted keys.

Note: When using the D-984VC VCA Control Module, perform gain settings as well for the output channel to be remotely controlled.

Step 5. Set individual functions as required.

(Refer to p. 18, Setting Flowcharts.)

Refer to the setting flowcharts for the appropriate setting method for the function to be used.

When using Stereo Link, Grouping and Crossover functions, first perform the required settings on the Utility setting screen.

Note

It is highly recommended that any changed parameters be immediately saved as preset memory on the Preset Memory setting screen. (Refer to p. 57, Preset Memory Save.) This permits the parameters of each function to be saved and protected, even if the power is switched off. All currently saved parameters can be recalled and reproduced when the power is switch on again. (Refer to p. 60, Initial Preset Memory Selection.) Settings need not be saved when temporarily setting or changing parameters.

6.2. Setting Flowcharts

All the functions described hereinafter can also be set at a PC using the dedicated software. Please access our website "<http://www.toa-products.com/international/>" for its download.

In the following charts, the Screen shift keys [▲▼] are used to move vertically (next screen display) and the shift keys [◀▶] to move horizontally between the solid line setting screen boxes (□). For movements within the dotted line setting screen boxes (⋯) and parameter settings for each setting screen, refer to the corresponding pages.

6.2.1. Input and output settings

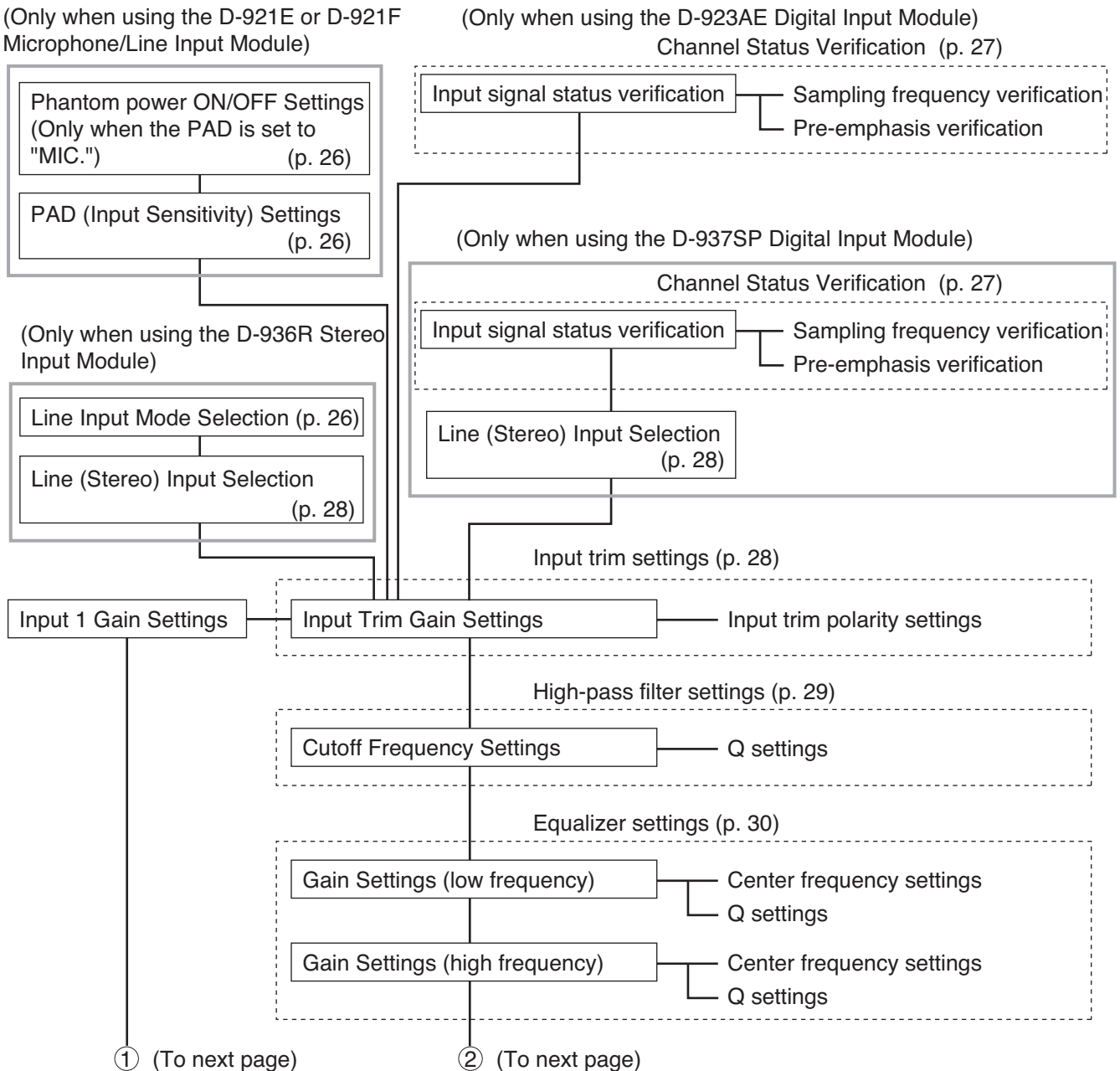

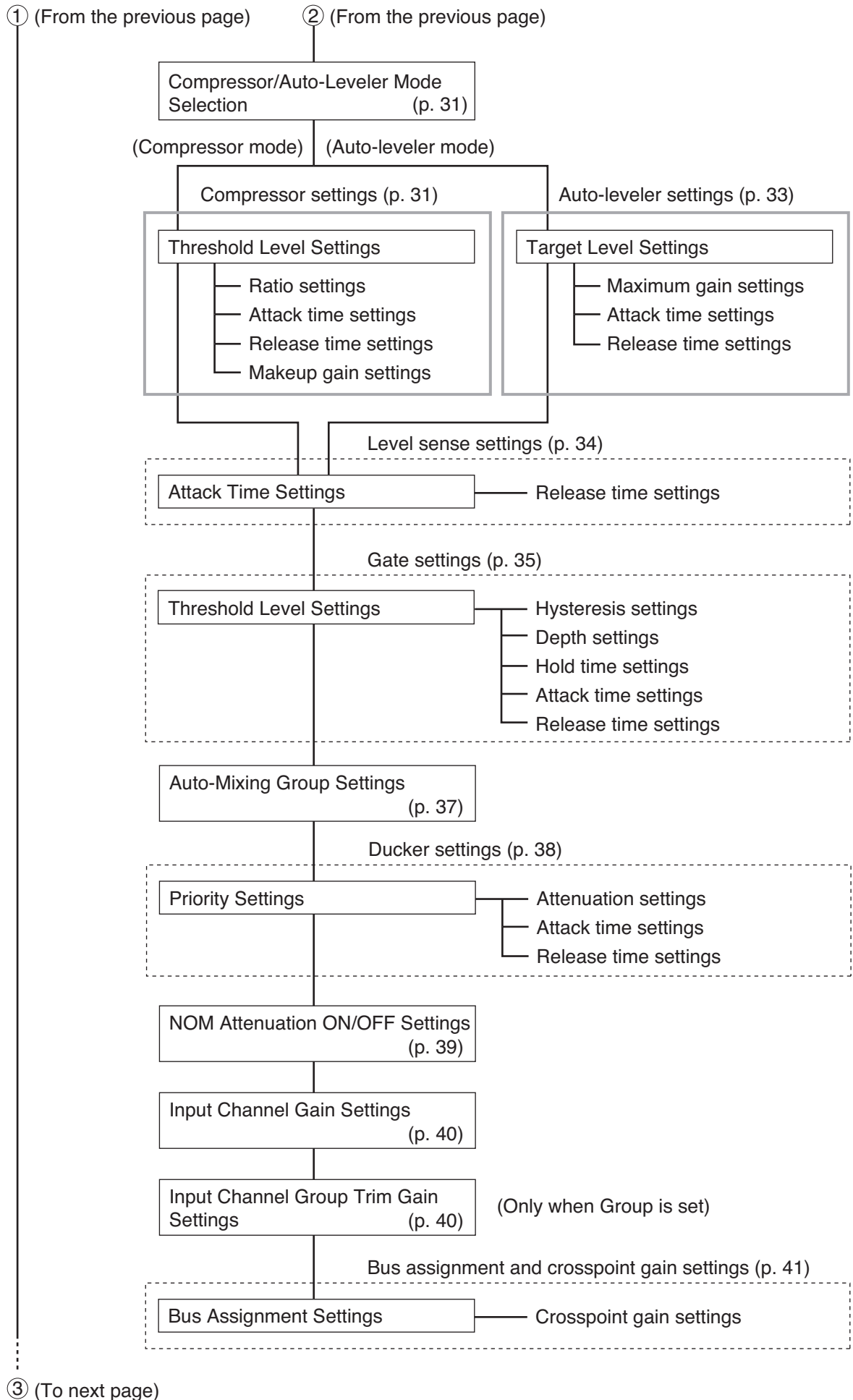

③ (From the previous page)

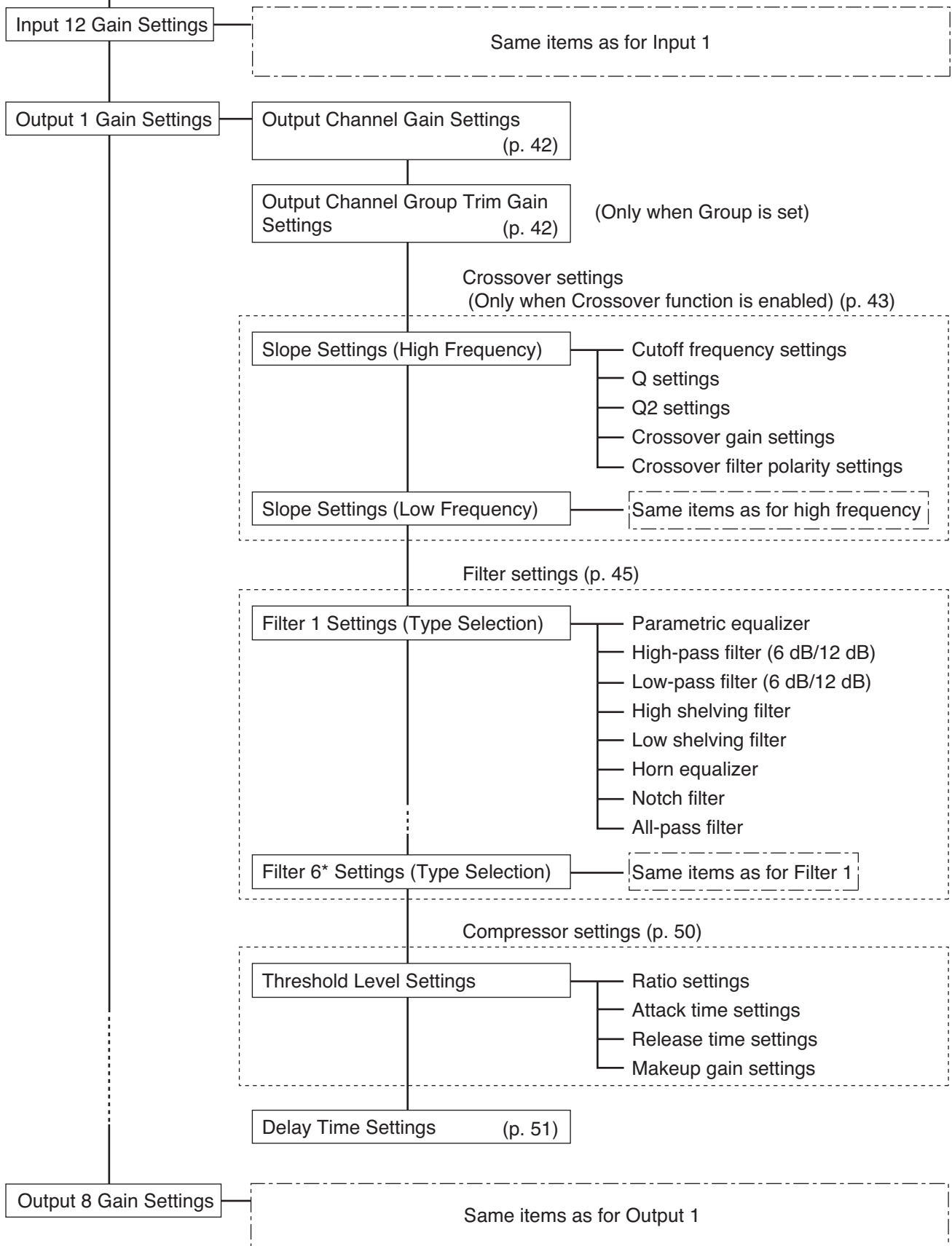

* The number of filters to be displayed differs depending on crossover configuration settings. (Refer to p. 62.)

6.2.2. Microphone bus settings

Microphone bus selector key

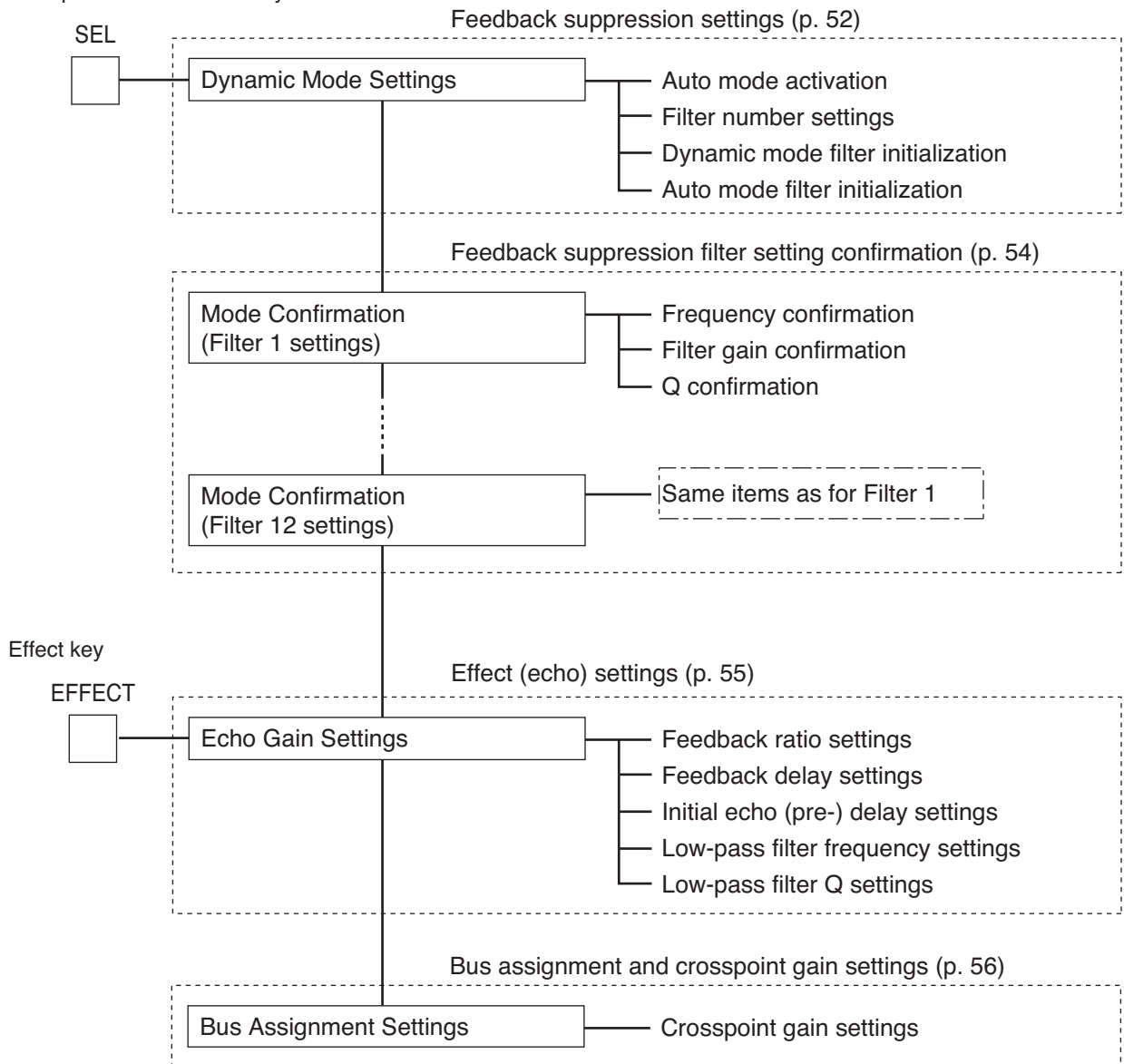

6.2.3. Preset memory settings

Preset key

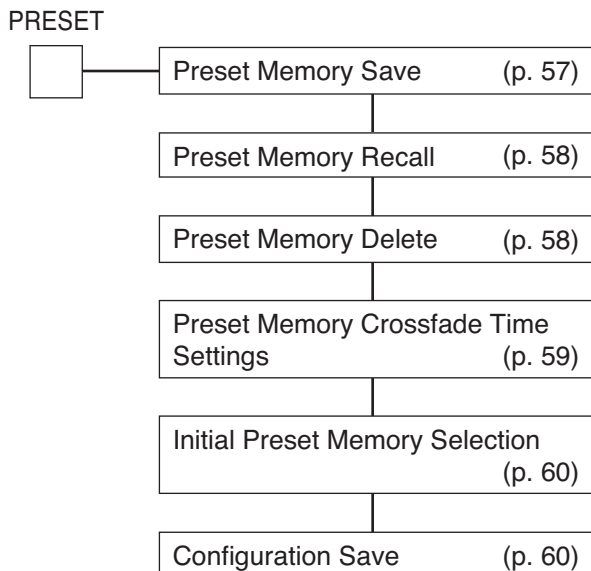

6.2.4. Utility settings

Utility key

UTILITY

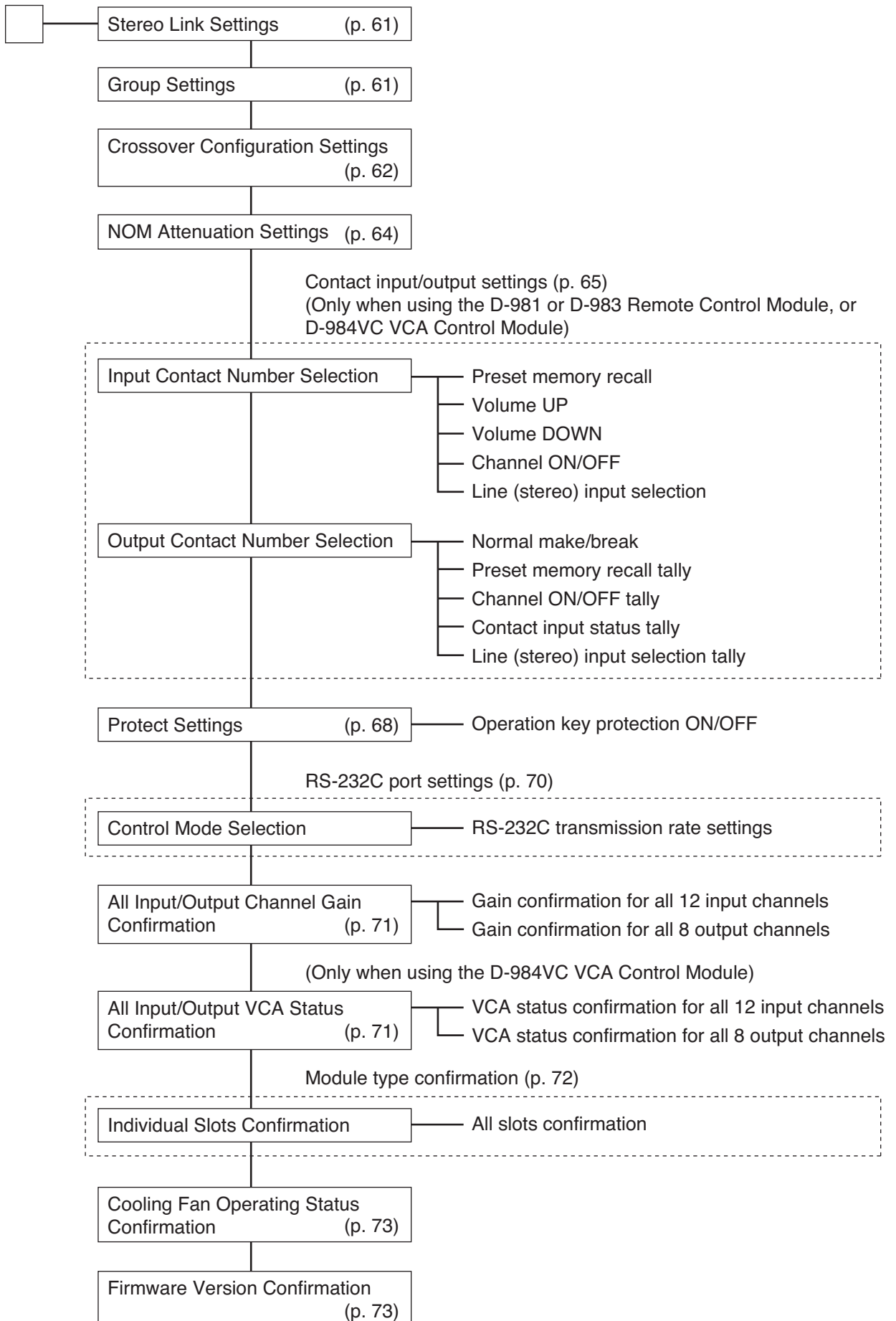

6.3. Setting Keys and Knob

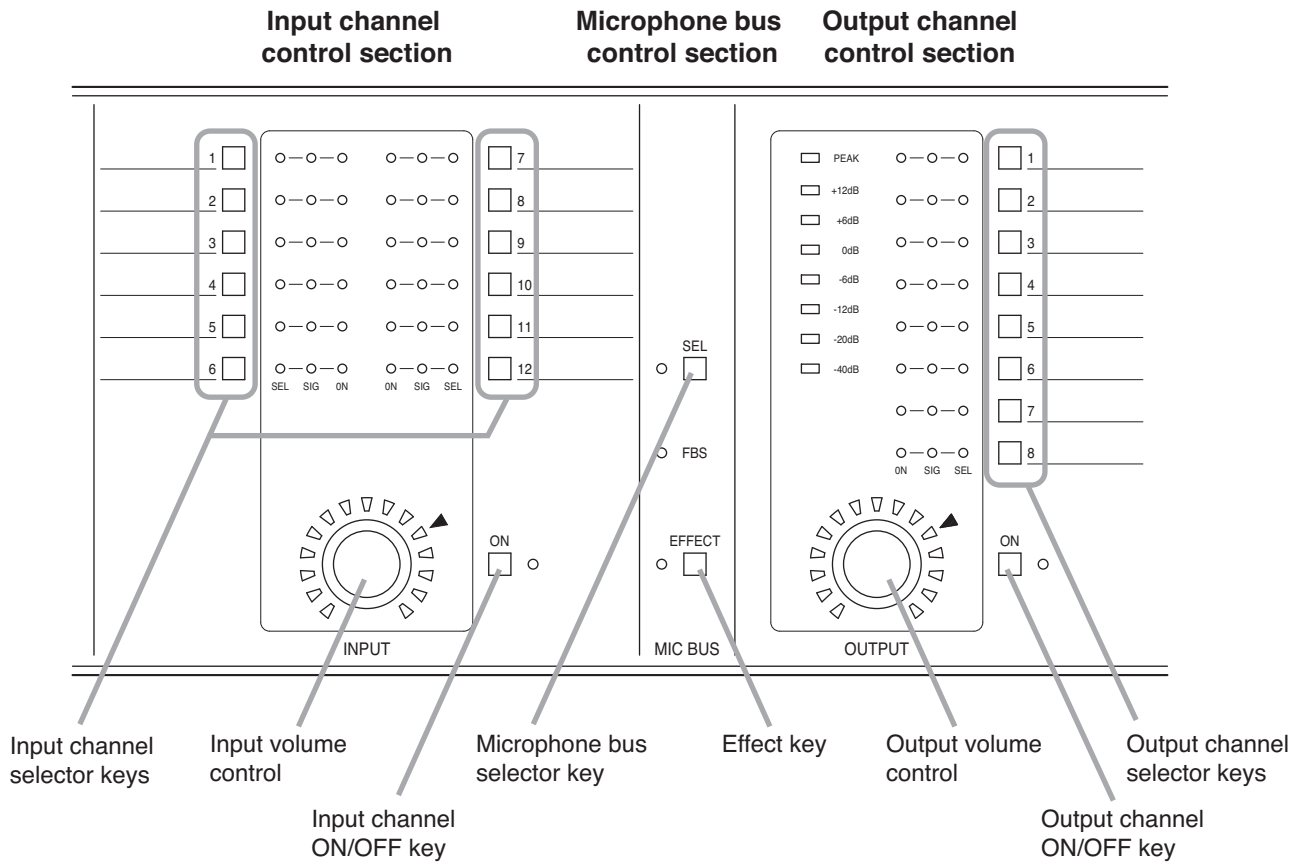
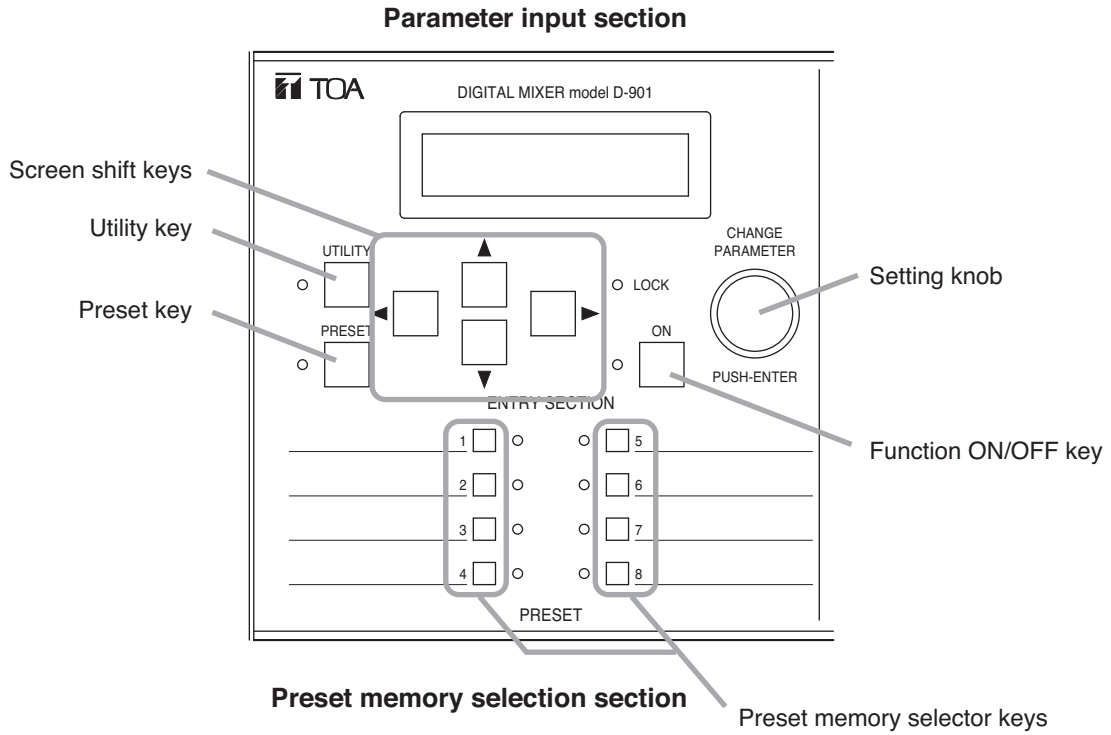

6.4. Setting Screen Displays

[Input/Output Gain Setting Screen Example]

Indicates the object currently being set. In this example, IN1 (Input 1) is the object being set. Pressing the ► shift key here switches the display to the input trim gain setting screen. The [IN 1]►TRIM indication is displayed on the first line, and the IN 1 (Input 1) trim gain becomes the setting object.

The channel selected with the Input channel selector key is displayed.

The channel selected with the Output channel selector key is displayed.

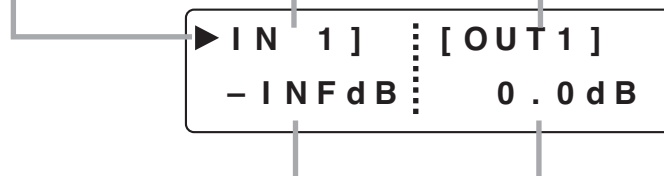

The gain of the input channel is displayed. In this example, the gain of Input channel 1 is displayed. Setting values can be changed using the Input volume control.

The gain of the output channel is displayed. In this example, the gain of Output channel 1 is displayed. Setting values can be changed using the Output volume control.

[Equalizer Setting Screen Example]

The channel number for which settings are to be changed is displayed.

The object currently being set is displayed.

Displayed when the previous screen exists. In this case, the PEQ-L (low frequency equalizer) setting screen appears when the ▲ shift key is pressed.



Displayed when the next screen exists. In this case, the COMPMODE (compressor/auto-leveler) setting screen appears when the ▼ shift key is pressed.

Setting items are displayed. In this example, the PEQ-H (high frequency equalizer) gain is being set. To change the frequency or Q of PEQ-H, press the ► shift key. The setting item display changes to FREQ and Q each time the ► shift key is pressed.

Parameters and selection contents can be changed with the Setting knob. In this example, the equalizer gain can be changed.

7. INPUT/OUTPUT GAIN SETTINGS

There are 3 possible setting methods.

7.1. Input and Output Channel Control Section Settings

Step 1. Press the desired Input (or Output) channel selector key.

The selected channel's SEL indicator lights.

Note

When Group setting is performed, selecting a channel in the group allows all SEL indicators of the input channels grouped together to light all at once.

Step 2. Rotate the Input (or Output) volume control to set the gain.

Input/output gain setting range:
-INF (-∞) to +10 dB

(Example: Input channel 1 gain setting)

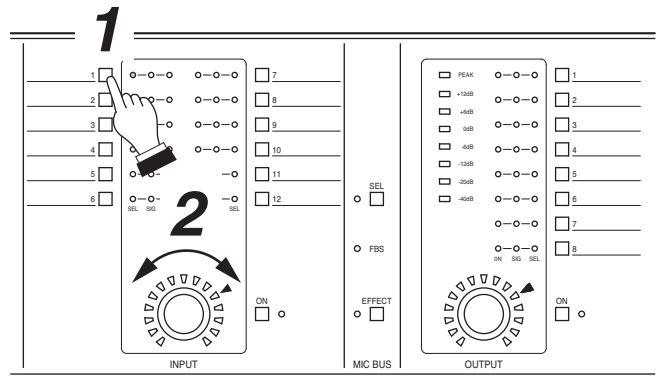

7.2. Input/Output Gain Setting Screen Operation

Step 1. Press the desired Input (or Output) channel selector key.

Step 2. Using the Screen shift key, display the input (or output) gain setting screen.

Step 3. Rotate the Setting knob to set the gain.

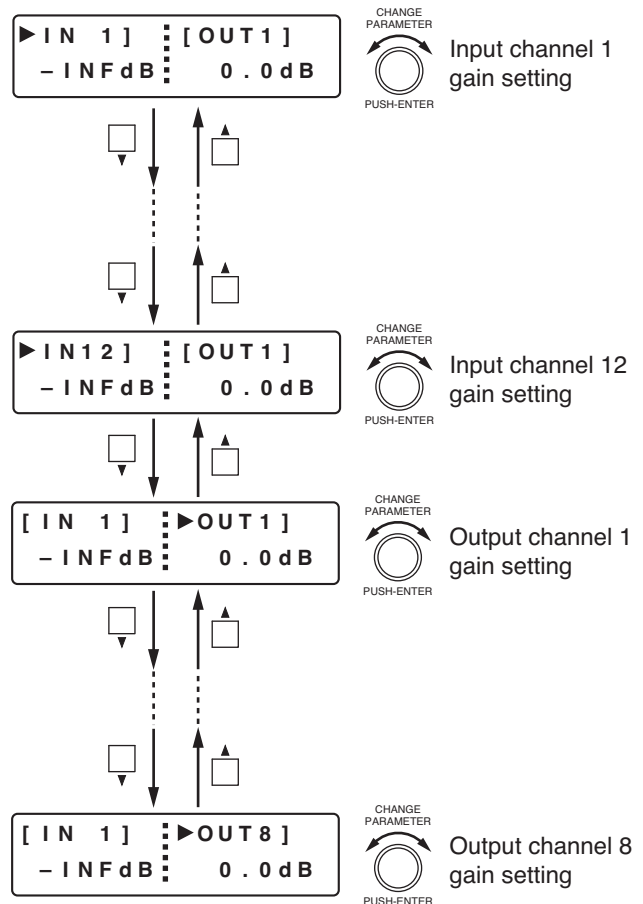

7.3. Input/Output Channel Gain Setting Screen Operation

Perform the "Input Channel Gain Settings" (p. 40) and "Output Channel Gain Settings" (p. 42).

8. INPUT-RELATED SETTINGS

The channel selected with the Input channel selector keys can be enabled or disabled using the Input channel ON/OFF key.

To enable or disable individual functions, use the function ON/OFF key when each function is displayed.

8.1. Phantom Power ON/OFF Settings (Only with D-921E or D-921F module)

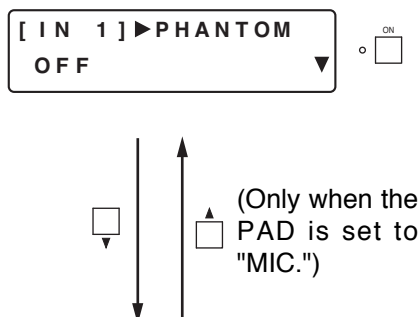

- Can be displayed and set only when MIC is selected on the PAD setting screen (explained in the next section).
- Enable or disable phantom power using the function ON/OFF key.

Note

Signals are muted for a specified period of time while changing settings.

- Pressing the Input channel selector key for the channel in which the D-921E or D-921F module is installed permits phantom power setting for that channel. The [IN 1] indication changes to the selected channel number indication.
- The setting screen reverts to the Input/Output Gain Setting screen when the ◀ shift key is pressed.

8.2. PAD (Input Sensitivity) Settings (Only with D-921E or D-921F module)

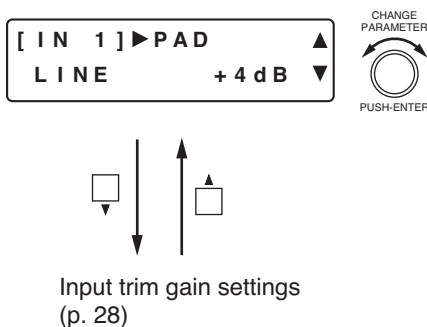

- Rotate the Setting knob to set the PAD (input sensitivity).
Parameter setting range: MIC: -50 or -36 dB
LINE: -10 or +4dB

Note

Signals are muted for a specified period of time while changing settings.

- Pressing the Input channel selector key for the channel in which the D-921E or D-921F module is installed permits PAD selection for that channel. The [IN 1] indication changes to the selected channel number indication.
- The setting screen reverts to the Input/Output Gain Setting screen when the ◀ shift key is pressed.

8.3. Line Input Mode Selection (Only with D-936R module)

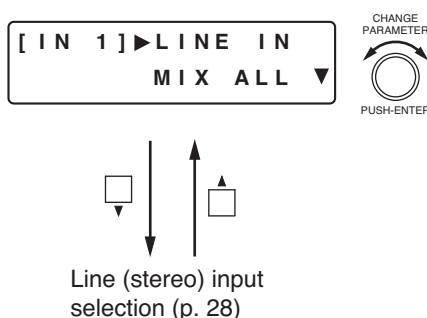

- Rotate the Setting knob to select the D-936R Stereo Input Module operation mode.
- Either a single stereo input can be selected from among the 4 available stereo inputs (SELECT mode) or all 4 stereo channels can be mixed (MIX ALL mode). Also, in MIX ALL mode, stereo sources can be selected with the input selection screen. (Refer to p. 28.)

Note

Signals are muted for a specified period of time while changing settings.

- The setting screen reverts to the Input/Output Gain Setting screen when the ◀ shift key is pressed.

8.4. Channel Status Verification (Only with D-923AE or D-937SP module)

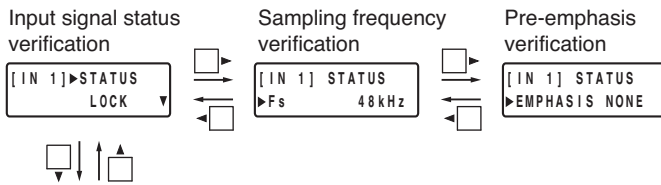

Using D-923AE: Input trim settings (next page)

Using D-937SP: Line (stereo) input selection (next page)

8.4.1. Input signal status verification



- Input signal status of each channel can be verified.

Display	Input signal status
LOCK	Normal
UNLOCK	No cable connected or equipment power not turned on
Non AUDIO	Not an audio signal
Non PCM	Not PCM data
DTS CD	DTS CD

8.4.2. Sampling frequency verification



- Sampling frequencies can be verified.
Display example: 32 kHz, 44.1 kHz, 48 kHz, 88.2 kHz, 96 kHz
- The indication of [- -] is displayed when it is impossible to recognize.
- Sampling rate converter (SRC) is always ON.

8.4.3. Pre-emphasis verification



- The "DETECT" indication is displayed when pre-emphasis is detected, automatically turning on the de-emphasis.



- The setting screen reverts to the Input/Output Gain Setting screen when the ◀ shift key is pressed.

8.5. Line (Stereo) Input Selection (Only with D-936R or D-937SP module)

Using D-936R: Line input mode selection (p. 26)

Using D-937SP: Channel status verification (previous page)

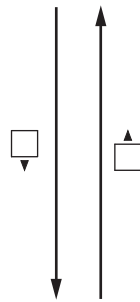
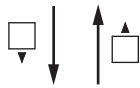

- Rotate the Setting knob to select the line (stereo) number and press the function ON/OFF key to enable or disable the input. For example, when the [IN 1] indication is displayed, settings are performed for the stereo module inserted into the unit's rear-mounted IN1 and 2 slot.
- The "-" indication is displayed when disabled.
- There are two operation modes for the module: MIX ALL and SELECT modes. (MIX ALL mode is provided with the D-936R only.)
 MIX ALL mode: Mixes 4 (stereo) line inputs. Any individual stereo input can also be disabled.
 SELECT mode: Selects a single (stereo) line input. Trim settings can be performed for individual line inputs.
- The setting screen reverts to the Input/Output Gain Setting screen when the ◀ shift key is pressed.

8.6. Input Trim Settings

Using D-921F or D-921E: PAD (Input sensitivity) settings (p. 26)

Using D-936R or D-937SP: Line (stereo) input selection (previous section)

Using D-923AE: Channel status verification (previous page)

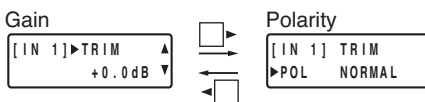

High-pass filter settings (next page)

8.6.1. Input trim gain settings

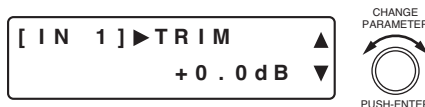

- Rotate the Setting knob to set the input trim gain.
 Parameter setting range: -15 to +15 dB in 0.1 dB steps
- Pressing an Input channel selector key allows the trim to be adjusted for that channel. The [IN 1] indication changes to the selected channel number indication.
- The setting screen reverts to the Input/Output Gain Setting screen when the ◀ shift key is pressed.

8.5.2. Input trim polarity settings



- Rotate the Setting knob to set the input trim polarity.
 Parameter setting range: NORMAL, INVERSE
- Pressing an Input channel selector key allows the trim to be adjusted for that channel. The [IN 1] indication changes to the selected channel number indication.

8.7. High-Pass Filter Settings

- ON The high-pass filter function can be enabled or disabled for the displayed channel by using the function ON/OFF key even when any of the following screens is displayed. The function ON/OFF Indicator lights when enabled (ON).

[Screen display operations]

Input trim settings (previous page)



Cutoff frequency



Q



Equalizer settings (next page)

8.7.1. Cutoff frequency settings



- Rotate the Setting knob to set the high-pass filter cutoff frequency.
Parameter setting range: 20 Hz – 20 kHz in 1/24 octave steps
Note: Slope is fixed at 12 dB/oct.
- Pressing an Input channel selector key permits the high-pass filter to be set for that channel. The [IN 1] indication changes to the selected channel number indication.
- The setting screen reverts to the Input/Output Gain Setting screen when the ◀ shift key is pressed.

8.7.2. Q settings



- Rotate the Setting knob to set the high-pass filter Q.
Parameter setting range: 0.500 – 2.563 (51 points)
- Pressing an Input channel selector key permits the high-pass filter to be set for that channel. The [IN 1] indication changes to the selected channel number indication.

8.8. Equalizer Settings

- ON When the (low or high frequency) Equalizer setting screen is displayed, equalization for the displayed channel can be enabled or disabled by pressing the function ON/OFF key. When enabled (ON), the function ON/OFF indicator lights.

[Screen display operations]

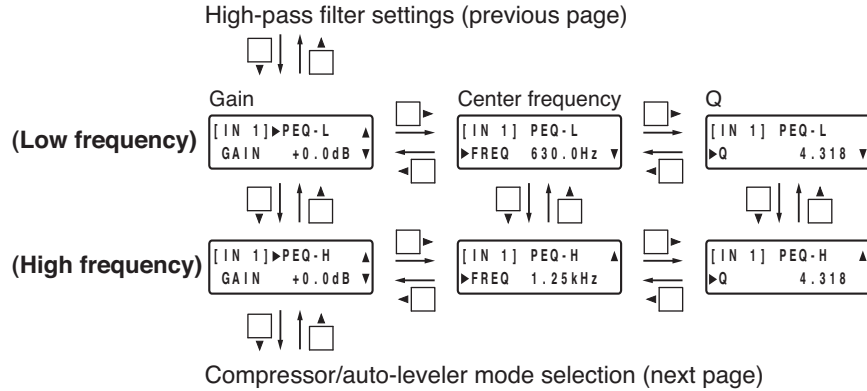

8.8.1. Gain settings

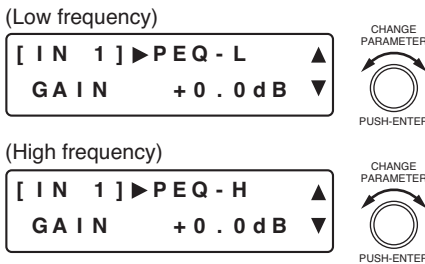

- Rotate the Setting knob to set the gain.
Parameter setting range: -15 to $+15$ dB in 0.1 dB steps
- Pressing an Input channel selector key permits the equalizer gain to be set for that channel. The [IN 1] indication changes to the selected channel number indication.
- The setting screen reverts to the Input/Output Gain Setting screen when the ◀ shift key is pressed.

8.8.2. Center frequency settings

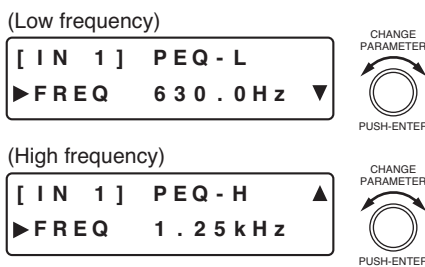

- Rotate the Setting knob to set the center frequency.
Parameter setting range: 20 Hz – 20 kHz in 1/24 octave steps
- Pressing an Input channel selector key permits the equalizer center frequencies to be set for that channel. The [IN 1] indication changes to the selected channel number indication.

8.8.3. Q settings

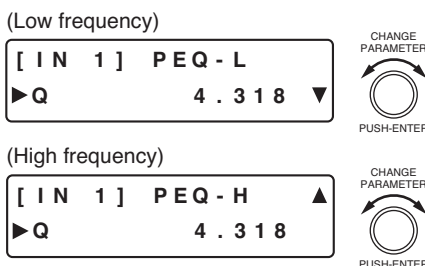

- Rotate the Setting knob to set the Q.
Parameter setting range: 0.267 – 69.249 (96 points)
- Pressing an Input channel selector key permits the equalizer Q to be set for that channel. The [IN 1] indication changes to the selected channel number indication.

8.9. Compressor/Auto-Leveler Mode Selection

Select which function to use, compressor (next section) or auto-leveler (p. 33).

Equalizer Settings
(previous page)

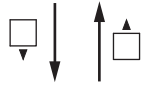

- Rotate the Setting knob to select compressor mode (COMP) or auto-leveler mode (LEVELER). Selecting the mode enables its corresponding function.

Refer to the next section for the compressor settings, and p. 33 for the auto-leveler settings.

- Changing the mode cancels the parameters for the newly selected mode even they have been preset, returning them to the default settings.
- Pressing an Input channel selector key permits the compressor mode or the auto-leveler mode to be set for that channel.
- The setting screen reverts to the Input/Output Gain Setting screen when the ◀ shift key is pressed.

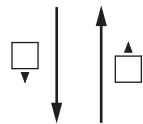

Compressor settings
(next section) or
auto-leveler settings (p. 33)

8.10. Compressor Settings (only when the compressor mode is selected in Section 8.9.)

Note

No following displays appear when the auto-leveler mode is selected.

- ON When any of the following screens is displayed, the compression function for the displayed channel can be enabled or disabled with the function ON/OFF key. When enabled (ON), the function ON/OFF Indicator lights.

[Screen display operations]

Compressor/auto-leveler mode selection (previous section)

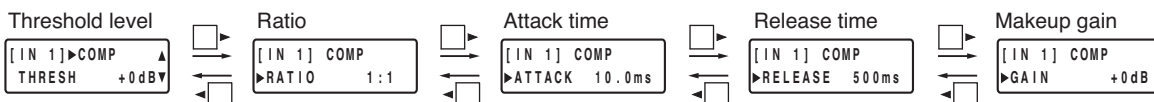

Level sense settings (p. 34)

8.10.1. Threshold level settings



- Rotate the Setting knob to set the threshold level. Parameter setting range: -20 to +20 dB in 1 dB steps
- Pressing an Input channel selector key permits the compression threshold level to be set for that channel. The [IN 1] indication changes to the selected channel number indication.
- The setting screen reverts to the Input/Output Gain Setting screen when the ◀ shift key is pressed.

8.10.2. Ratio settings



- Rotate the Setting knob to set the ratio.
Parameter setting range: 1:1, 2:1, 3:1, 4:1, 8:1, 12:1, 20:1, INF (∞):1
- Pressing an Input channel selector key permits the compression ratio to be set for that channel. The [IN 1] indication changes to the selected channel number indication.

8.10.3. Attack time settings



- Rotate the Setting knob to set the attack time.
Parameter setting range: 0.2 ms – 5 s (Refer to p. 87 for more information.)
- Pressing an Input channel selector key permits the compression attack time to be set for that channel. The [IN 1] indication changes to the selected channel number indication.

8.10.4. Release time settings



- Rotate the Setting knob to set the release time.
Parameter setting range: 10 ms – 5 s (Refer to p. 87 for more information.)
- Pressing an Input channel selector key permits the compression release time to be set for that channel. The [IN 1] indication changes to the selected channel number indication.

8.10.5. Makeup gain settings



- Rotate the Setting knob to set the makeup gain.
Parameter setting range: -INF ($-\infty$) to +10 dB, in 1 dB steps
- Pressing an Input channel selector key permits the compression makeup gain to be set for that channel. The [IN 1] indication changes to the selected channel number indication.

8.11. Auto-Leveler Settings (only when the auto-leveler mode is selected in Section 8.9.)

The auto-leveler function performs to keep the output level constant by suppressing the change of sound volume. Setting the target level (the constant level to be automatically adjusted to) and the maximum gain (the amount of gain to bring the lower level to the target level) automatically compensates for the input level. Note that setting an excessive amount of gain increases the input sensitivity, easily causing feedback.

Note: No following displays appear when the compressor mode is selected.

- ON When any of the following screens is displayed, the auto-leveler function for the displayed channel can be enabled or disabled with the function ON/OFF key. When enabled (ON), the function ON/OFF Indicator lights.

[Screen display operations]

Compressor/auto-leveler mode selection (p. 31)

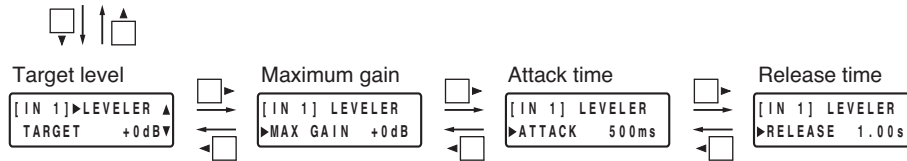

Level sense settings (next page)

8.11.1. Target level settings



- Rotate the Setting knob to set the target level.
Parameter setting range: -20 to +10 dB in 1 dB steps
- Pressing an Input channel selector key set for the auto-leveler mode permits the auto-leveler target level to be set for that channel. The [IN 1] indication changes to the selected channel number indication.
- The setting screen reverts to the Input/Output Gain Setting screen when the ◀ shift key is pressed.

8.11.2. Maximum gain settings



- Rotate the Setting knob to set the maximum gain.
Parameter setting range: 0 to +20 dB in 1 dB steps
- Pressing an Input channel selector key set for the auto-leveler mode permits the auto-leveler maximum gain to be set for that channel. The [IN 1] indication changes to the selected channel number indication.

8.11.3. Attack time settings



- Rotate the Setting knob to set the attack time.
Parameter setting range: 10 ms – 10 s (Refer to p. 88 for more information.)
- Pressing an Input channel selector key set for the auto-leveler mode permits the auto-leveler attack time to be set for that channel. The [IN 1] indication changes to the selected channel number indication.

8.11.4. Release time settings



- Rotate the Setting knob to set the release time. Parameter setting range: 100 ms – 10 s (Refer to p. 88 for more information.)
- Pressing an Input channel selector key set for the auto-leveler mode permits the auto-leveler release time to be set for that channel. The [IN 1] indication changes to the selected channel number indication.

8.12. Level Sense Settings

The level sense refers to a parameter used to adjust the sensitivity by which the gate detects an input signal level. Proper attack time settings prevent the gate function from being accidentally triggered by pulse noise. (Refer to the next page.)

[Screen display operations]

Compressor settings (p. 31) or Auto-leveler settings (previous page)

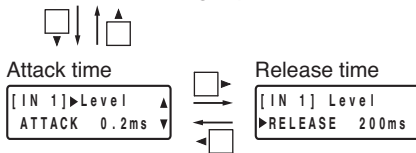

Gate settings (next page)

8.12.1. Attack time settings



- Rotate the Setting knob to set the attack time. Parameter setting range: 0.2 ms – 5 s (Refer to p. 88 for more information.)
- Pressing an Input channel selector key permits the level sense attack time to be set for that channel. The [IN 1] indication changes to the selected channel number indication.
- The setting screen reverts to the Input/Output Gain Setting screen when the ◀ shift key is pressed.

8.12.2. Release time settings



- Rotate the Setting knob to set the release time. Parameter setting range: 10 ms – 5 s (Refer to p. 88 for more information.)
- Pressing an Input channel selector key permits the level sense release time to be set for that channel. The [IN 1] indication changes to the selected channel number indication.

8.13. Gate Settings

The gate function allows the input signal to be passed, attenuated or cut depending on its signal level.

The gate allows the signal to pass when open, and attenuates or cuts the signal when closed. The gate opens when the input signal reaches a level above the Threshold plus Hysteresis parameter (half the Hysteresis) as shown in the figure at right. Once open, the input signal must reach a level below the Threshold minus Hysteresis parameter to close. The Ducker function (p. 38) and the NOM attenuation function (p. 39) are controlled by the gate's open/close operations.

[Example: Hysteresis parameter is set to +10 dB.]

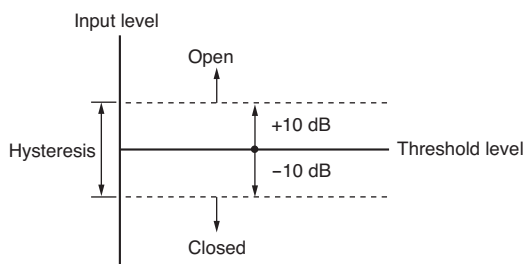

- ON When any of the following screens is displayed, the gate function for the displayed channel can be enabled or disabled with the function ON/OFF key. When enabled (ON), the function ON/OFF Indicator lights.

Note: When an input channel is set to OFF, the gate function on that channel does not operate.

[Screen display operations]

Level sense settings (previous page)

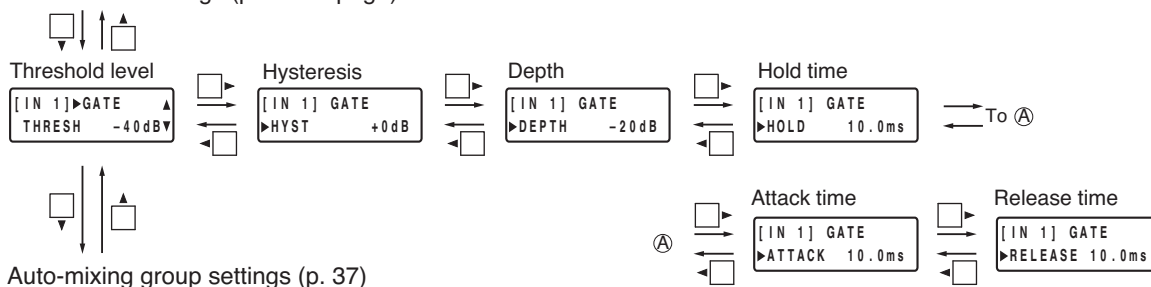

8.13.1. Threshold level settings



- Rotate the Setting knob to set the threshold level. Parameter setting range: -50 to +20 dB in 1 dB steps
- Pressing an Input channel selector key permits the gate threshold level to be set for that channel. The [IN 1] indication changes to the selected channel number indication.
- The setting screen reverts to the Input/Output Gain Setting screen when the ◀ shift key is pressed.

8.13.2. Hysteresis settings



- Rotate the Setting knob to set the hysteresis (the difference between the input signal levels used to open and close the gate). Parameter setting range: 0 to +10 dB in 1 dB steps
- Pressing an Input channel selector key permits the gate hysteresis to be set for that channel. The [IN 1] indication changes to the selected channel number indication.

8.13.3. Depth settings

[IN 1] GATE
▶DEPTH - 20 dB



- Rotate the Setting knob to set the depth (signal attenuation when the gate is closed).
Parameter setting range: $-\text{INF}$ ($-\infty$) to 0 dB in 1 dB steps
- Pressing an Input channel selector key permits the gate depth to be set for that channel. The [IN 1] indication changes to the selected channel number indication.

8.13.4. Hold time settings

[IN 1] GATE
▶HOLD 10.0 ms



- Rotate the Setting knob to set the hold time (the interval the gate is kept open when an input signal level drops below the closing threshold level).
Parameter setting range: 10 ms – 10 s (Refer to p. 88 for more information.)
- Pressing an Input channel selector key permits the gate hold time to be set for that channel. The [IN 1] indication changes to the selected channel number indication.

8.13.5. Attack time settings

[IN 1] GATE
▶ATTACK 10.0 ms



- Rotate the Setting knob to set the attack time (the time required for the gate to open).
Parameter setting range: 10 ms – 10 s (Refer to p. 88 for more information.)
- Pressing an Input channel selector key permits the gate attack time to be set for that channel. The [IN 1] indication changes to the selected channel number indication.

8.13.6. Release time settings

[IN 1] GATE
▶RELEASE 10.0 ms



- Rotate the Setting knob to set the release time (the time required for attenuation to reach the gain set in the depth setting when the gate is closed).
Parameter setting range: 10 ms – 10 s (Refer to p. 88 for more information.)
- Pressing an Input channel selector key permits the gate release time to be set for that channel. The [IN 1] indication changes to the selected channel number indication.

8.14. Auto-Mixing Group Settings

Both the Ducker function (next page) and the NOM Attenuation function (p. 39) are Auto-Mixing Functions that automatically adjust individual input channel gains in response to input signal level.

The auto-mixing functions can operate in each of the 4 groups, GROUP A through D. Although all the input channels are grouped into GROUP A by default, they can be individually assigned to the desired groups.

The figure below shows the block diagram of the Auto-Mixing (Auto MIX) section.

[Auto-mixing block diagram]

The diagram below shows an example where the input channels 1 and 2 are assigned to GROUP A, and the input channels 3 and 4 to GROUP B.

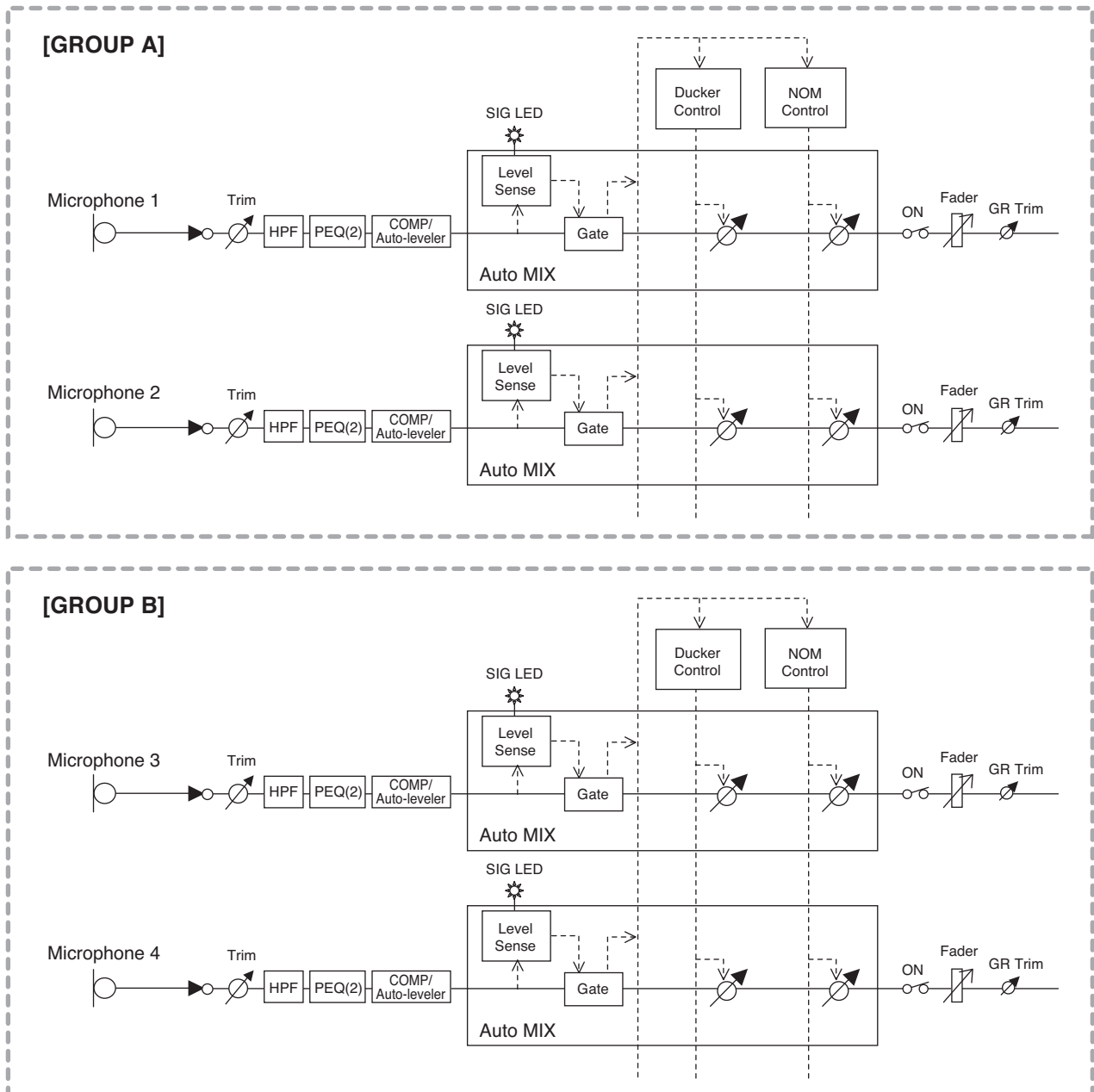

Gate settings (p. 35)

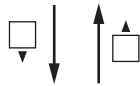

- Rotate the Setting knob to select a group from GROUP A to D.
- Pressing an Input channel selector key permits the auto-mixing group to be set for that channel. The [IN 1] indication changes to the selected channel number indication.
- The setting screen reverts to the Input/Output Gain Setting screen when the ◀ shift key is pressed.

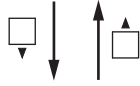

8.15. Ducker Settings

The ducker function is one of the D-901's auto-mixing functions, and automatically adjusts individual input channel gains in response to input signal level. Refer to the previous page for the block diagram of the Auto-Mixing section.

When a received signal exceeds the gate threshold level, the ducker function automatically attenuates all other input signals which are lower than that input channel in priority.

This function operates in individual auto-mixing groups (previous page).

- ON When any of the following screens is displayed, the ducker function for the displayed channel can be enabled or disabled by means of the function ON/OFF key. When enabled (ON), the function ON/OFF Indicator lights.

Note: When an input channel is set to OFF, the ducker function on that channel does not operate.

[Screen display operations]

Auto-mixing group settings (previous page)



Priority order



Attenuation



Attack time



Release time



NOM attenuation ON/OFF settings (next page)

8.15.1. Priority settings



- Rotate the Setting knob to set priorities. Parameter setting range: 1 – 8 (1: Highest priority; 8: Lowest priority)
- Pressing an Input channel selector key permits ducker priorities to be set for that channel. The [IN 1] indication changes to the selected channel number indication.
- The setting screen reverts to the Input/Output Gain Setting screen when the ◀ shift key is pressed.

8.15.2. Attenuation settings



- Rotate the Setting knob to set an attenuation. Parameter setting range: -INF (-∞) to 0 dB in 1 dB steps
- Pressing an Input channel selector key permits the ducker attenuation to be set for that channel. The [IN 1] indication changes to the selected channel number indication.

8.15.3. Attack time settings



- Rotate the Setting knob to set the attack time (the time required for the attenuation to be a set value).
Parameter setting range: 10 ms – 10 s (Refer to p. 88 for more information.)
- Pressing an Input channel selector key permits the ducker attack time to be set for that channel. The [IN 1] indication changes to the selected channel number indication.

8.15.4. Release time settings



- Rotate the Setting knob to set the release time (the time required for the attenuation to reach the original gain of 0 dB).
Parameter setting range: 10 ms – 10 s (Refer to p. 88 for more information.)
- Pressing an Input channel selector key permits the ducker release time to be set for that channel. The [IN 1] indication changes to the selected channel number indication.

8.16. NOM Attenuation ON/OFF Settings

The NOM Attenuation function is one of the D-901's auto-mixing functions, and automatically adjusts individual input channel gains in response to input signal level. Refer to p. 37 for the block diagram of the Auto-Mixing section.

NOM is an acronym of Number of Open Microphones, and represents the number of microphones in open status (the number of input channels with open gates).

The NOM attenuation function automatically adjusts the open microphone's input channel gain depending on the number of open microphones. The open microphone channel gain is attenuated by the gain set on the Utility setting screen (p. 61) each time the number of open microphones doubles. The use of this function allows an output level to be kept constant, thus helping to prevent feedback.

This function operates in individual auto-mixing groups (p. 37).

Note: When an input channel is set to OFF, the NOM function on that channel does not operate.

Ducker settings
(previous page)

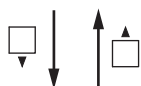
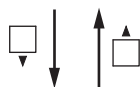

Input channel gain
settings (next page)

- Press the function ON/OFF key to enable or disable the NOM attenuation function for individual input channels.
- Pressing an Input channel selector key enables or disables the NOM attenuation function for that channel. The [IN 1] indication changes to the selected channel number indication.
- The setting screen reverts to the Input/Output Gain Setting screen when the ◀ shift key is pressed.

8.17. Input Channel Gain Settings

NOM attenuation
ON/OFF settings
(previous page)

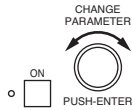
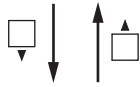

- Rotate the Setting knob to set the input channel gain. Parameter setting range: $-\text{INF}$ ($-\infty$) to +10 dB
- Press the function ON/OFF key to enable or disable the channel.
- Pressing an Input channel selector key permits the gain to be set for that channel. The [IN 1] indication changes to the selected channel number indication.
- The setting screen reverts to the Input/Output Gain Setting screen when the ◀ shift key is pressed.

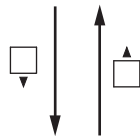

Bus assignment settings
(next page) or Input
channel group trim gain
settings (next section)

8.18. Input Channel Group Trim Gain Settings (Only when Group is set)



- The indication at left is displayed only when Group setting is performed. Perform the Group settings on the Utility setting screen (p. 61).
- Rotate the Setting knob to set the group trim gain (offset gain). Parameter setting range: $-\text{INF}$ ($-\infty$) to +10 dB in 0.1 dB steps
- Pressing an Input channel selector key permits the group trim gain to be set for that channel. The [IN 1] indication changes to the selected channel number indication.
- The setting screen reverts to the Input/Output Gain Setting screen when the ◀ shift key is pressed.

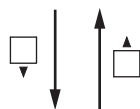

Bus assignment and
crosspoint gain settings
(next page)

8.19. Bus Assignment and Crosspoint Gain Settings

[Screen display operations]

Input channel gain settings (previous page) or Input channel group trim gain settings (previous page)

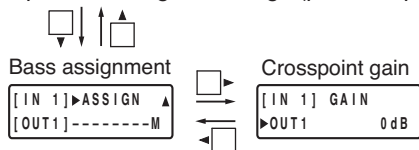

8.19.1. Bus assignment settings

Set input-to-output signal paths.



- Rotate the Setting knob to select the output channel bus (1 – 8 or MicB*), then press the function ON/OFF key to enable or disable the assignment.

* Microphone bus : The "M" indication is displayed when enabled.

[Setting example]



- Pressing an Input channel selector key permits the bus assignment to be set for that channel. The [IN 1] indication changes to the selected channel number indication.
- The setting screen reverts to the Input/Output Gain Setting screen when the ◀ shift key is pressed.

Note

The bus assignment settings can also be performed using only the input/output channel controls on the front panel.

(Example: Input channel 1 Æ Output channels 5 and 8)

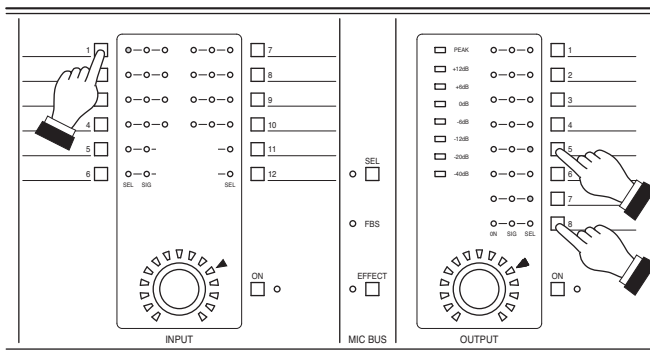

Press the desired Output channel selector key(s) while holding down the Input channel selector key.

The set output channel's indicator [SEL] lights.

Pressing the microphone bus selector key sends the signal from the selected input channel to the microphone bus.

Tip

The channel is simultaneously assigned to both L and R channels when assigned from "stereo-linked" input channels to "stereo-linked" output channels. (Refer to p. 56 Stereo Link Settings.)

[Example] When Inputs 1 and 2 and outputs 1 and 2 are both "stereo-linked," pressing the Input Channel 1 selector key and Output Channel 1 selector key sets the assignment of Input 1 → Output 1 and Input 2 → Output 2, causing the Output Channels 1 and 2 indicators [SEL] to light.

8.19.2. Crosspoint gain settings



- Rotate the Setting knob to set the crosspoint gain. Parameter setting range: -INF (-∞) to 0 dB in 1 dB steps
- Pressing an Input channel selector key permits the input channel selection.
- Pressing an Output channel selector key permits the output channel selection.
- Pressing the function ON/OFF key enables or disables the selected assignment.

9. OUTPUT SETTINGS

Output channels selected with the Output channel selector keys can be enabled or disabled using the output channel ON/OFF key. Use the function ON/OFF key to enable or disable each function displayed on the LCD screen.

9.1. Output Channel Gain Settings

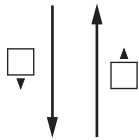
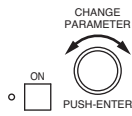

Filter settings (p. 45),
Output channel group
trim gain settings (next
section), or Crossover
settings (next page)

- Rotate the Setting knob to set the output channel gain.
Parameter setting range: $-\text{INF}$ ($-\infty$) to +10 dB
- Press the function ON/OFF key to enable or disable the displayed channel.
- Pressing an Output channel selector key permits the gain to be set for that channel. The [OUT 1] indication changes to the selected channel number indication.
- The setting screen reverts to the Input/Output Gain Setting screen when the ◀ shift key is pressed.

9.2. Output Channel Group Trim Gain Settings (Only when Group is set)

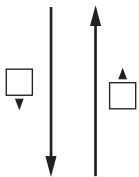

Crossover settings
(next page) or
Filter settings (p. 45)

- The indication at left is displayed only when Group setting is performed. Perform the Group settings on the Utility setting screen (p. 56).
- Rotate the Setting knob to set the group trim gain (offset gain).
Parameter setting range: $-\text{INF}$ ($-\infty$) to +10 dB in 0.1 dB steps
- Pressing an Output channel selector key permits the group trim gain to be set for that channel. The [OUT 1] indication changes to the selected channel number indication.
- The setting screen reverts to the Input/Output Gain Setting screen when the ◀ shift key is pressed.

9.3. Crossover Settings (Only when Crossover function is enabled)

The following screens are displayed only when the crossover function is enabled on the Utility setting screen. (Refer to p. 62 for more information.)

[Screen display operations]

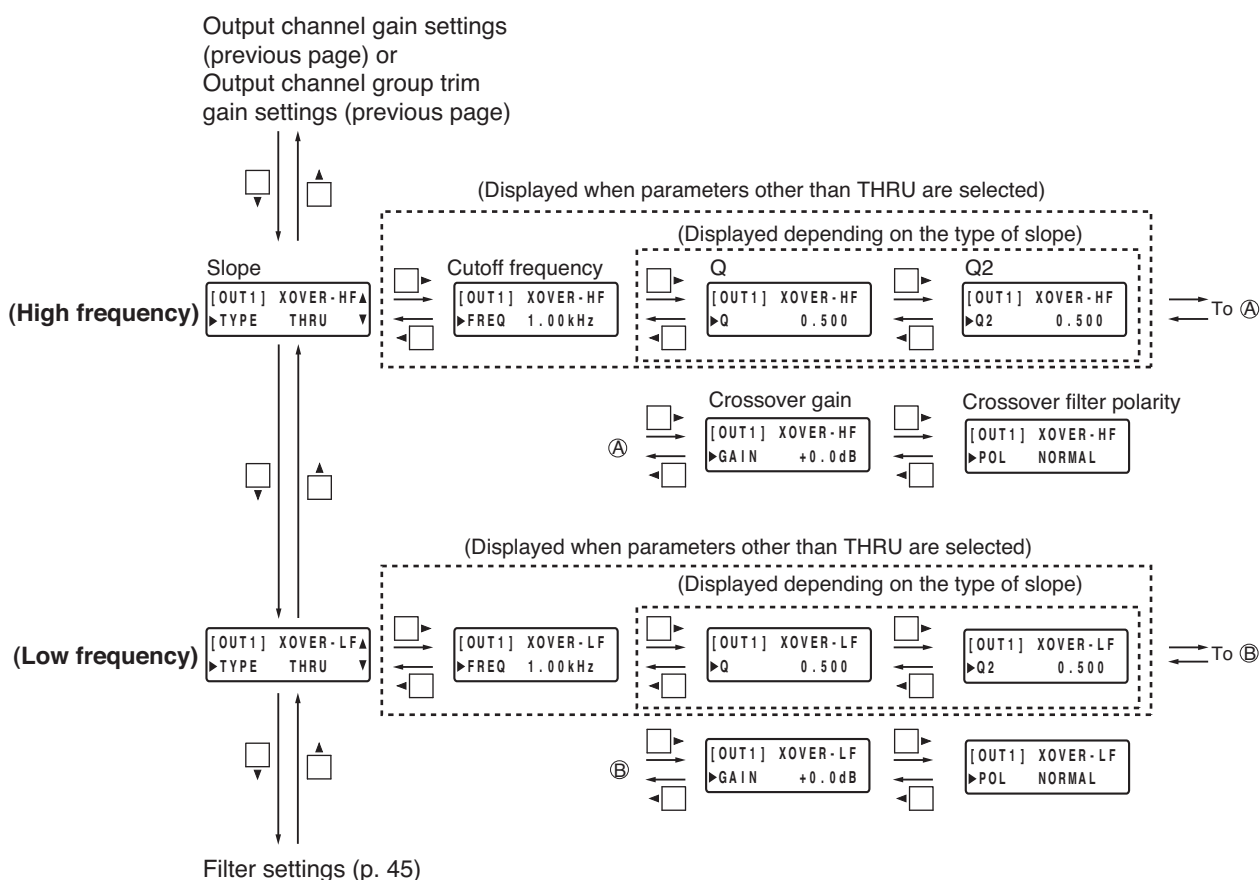

9.3.1. Slope settings

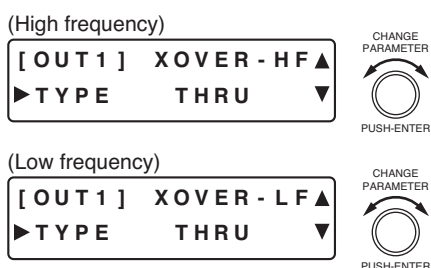

- Rotate the Setting knob to select the type of slope. Parameter setting range: THRU (through), 6 dB (6 dB/oct), 12BS (12 dB/oct BS), etc. (Refer to p. 89 for more information.)

Notes

- (1) Slope type: BS (Bessel), BW (Butterworth), LR (Linkwitz-Riley), VQ (Variable Q)
 - (2) Displayed slope type differs depending on the Crossover configuration setting. (Refer to p. 62.)
- Using the ► shift key, the display is moved to the Crossover Gain setting screen if THRU is selected, and to the Cutoff Frequency setting screen if parameters other than THRU are set.
 - Pressing an Output channel selector key permits the crossover filter to be set for that channel. The [OUT 1] indication changes to the selected channel number indication.

9.3.2. Cutoff frequency settings

(High frequency)

[OUT 1] X O V E R - H F
 ► F R E Q 1 . 0 0 k H z

CHANGE
PARAMETER



PUSH-ENTER

(Low frequency)

[OUT 1] X O V E R - L F
 ► F R E Q 1 . 0 0 k H z

CHANGE
PARAMETER



PUSH-ENTER

- Rotate the Setting knob to set the cutoff frequency.
Parameter setting range: 20 Hz – 20 kHz in 1/24 octave steps
- Pressing an Output channel selector key permits the crossover filter to be set for that channel. The [OUT 1] indication changes to the selected channel number indication.

9.3.3. Q settings

(High frequency)

[OUT 1] X O V E R - H F
 ► Q 0 . 5 0 0

CHANGE
PARAMETER



PUSH-ENTER

(Low frequency)

[OUT 1] X O V E R - L F
 ► Q 0 . 5 0 0

CHANGE
PARAMETER



PUSH-ENTER

- The Q setting can be performed only when the type of slope is VQ.
- Rotate the Setting knob to set the Q.
Parameter setting range: 0.500 – 2.563 (51 points)
- Pressing an Output channel selector key permits the crossover filter to be set for that channel. The [OUT 1] indication changes to the selected channel number indication.

9.3.4. Q2 settings

(High frequency)

[OUT 1] X O V E R - H F
 ► Q 2 0 . 5 0 0

CHANGE
PARAMETER



PUSH-ENTER

(Low frequency)

[OUT 1] X O V E R - L F
 ► Q 2 0 . 5 0 0

CHANGE
PARAMETER



PUSH-ENTER

- The Q2 setting can be performed only when the type of slope is 24VQ.
- Rotate the Setting knob to set the Q2.
Parameter setting range: 0.500 – 2.563 (51 points)
- Pressing an Output channel selector key permits the crossover filter to be set for that channel. The [OUT 1] indication changes to the selected channel number indication.

9.3.5. Crossover gain settings

(High frequency)

[OUT 1] X O V E R - H F
 ► G A I N + 0 . 0 d B

CHANGE
PARAMETER



PUSH-ENTER

(Low frequency)

[OUT 1] X O V E R - L F
 ► G A I N + 0 . 0 d B

CHANGE
PARAMETER



PUSH-ENTER

- Rotate the Setting knob to set the crossover gain.
Parameter setting range: –15 to +15 dB in 0.1 dB steps
- Pressing an Output channel selector key permits the crossover filter to be set for that channel. The [OUT 1] indication changes to the selected channel number indication.

9.3.6. Crossover filter polarity settings

(High frequency)

[OUT 1] X O V E R - H F
 ► P O L N O R M A L

CHANGE
PARAMETER



PUSH-ENTER

(Low frequency)

[OUT 1] X O V E R - L F
 ► P O L N O R M A L

CHANGE
PARAMETER



PUSH-ENTER

- Rotate the Setting knob to set the crossover filter polarity.
Parameter setting range: NORMAL and INVERSE
- Pressing an Output channel selector key permits the crossover filter to be set for that channel. The [OUT 1] indication changes to the selected channel number indication.

9.4. Filter Settings

- ON When any of the following screens is displayed, the filter function for the displayed channel can be enabled or disabled by pressing the function ON/OFF key. When enabled (ON), the function ON/OFF Indicator lights.

[Screen display operations]

Output channel gain settings (p. 42), Output channel group trim gain settings (p. 42), or Crossover settings (p. 43)

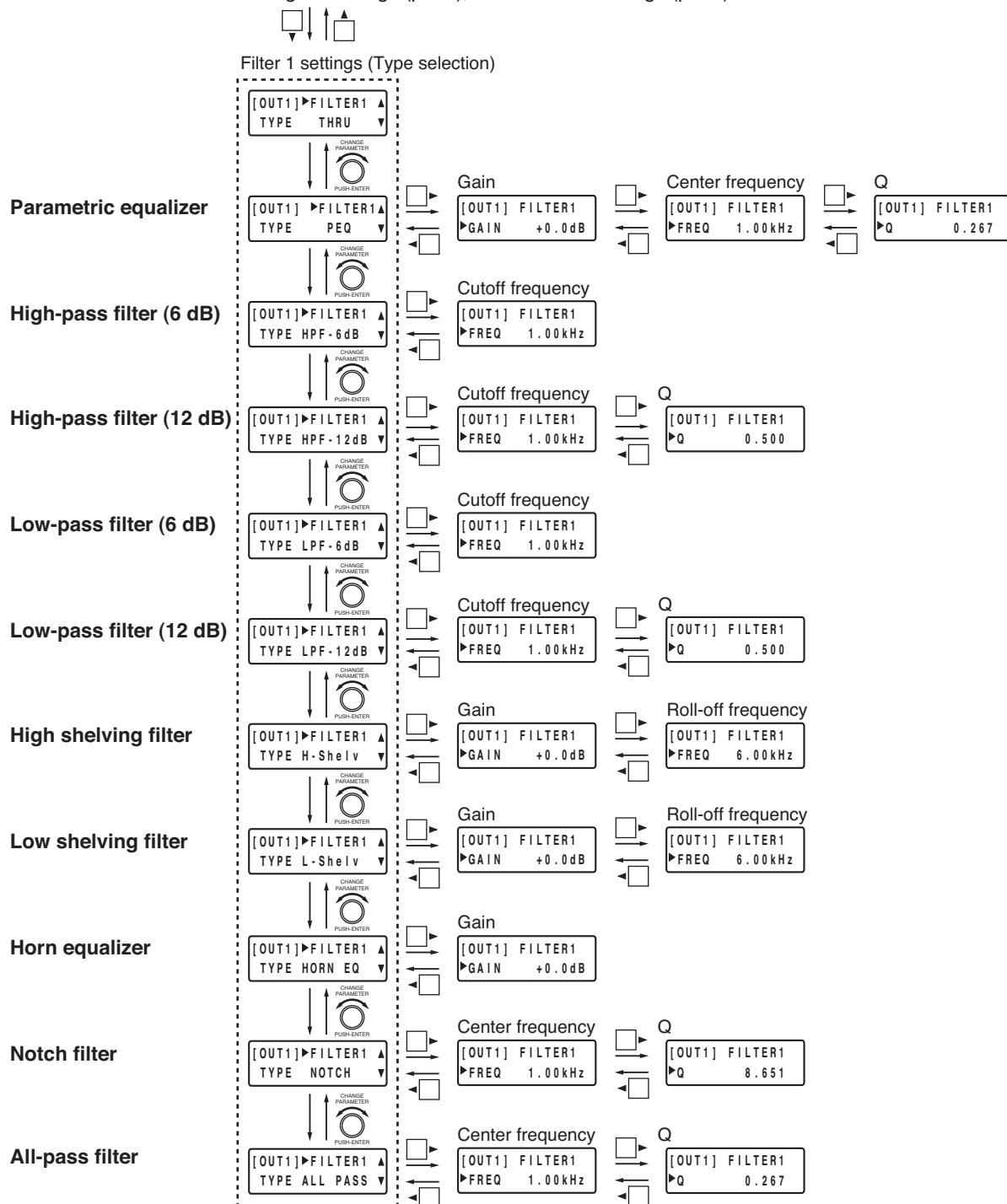

Filter 6* settings (Type selection)



Compressor settings (p. 50)

* The number of displayed filters differs depending on the crossover configuration settings on the Utility setting screen. (Refer to p. 62.)

Tip

Filters range from 1 to 6 in number, and the setting items for each filter are the same. Press the ▲ and ▼ shift keys to change the filter number.

[Setting procedures (Example of setting output 1 – filter 2 as a horn equalizer)]

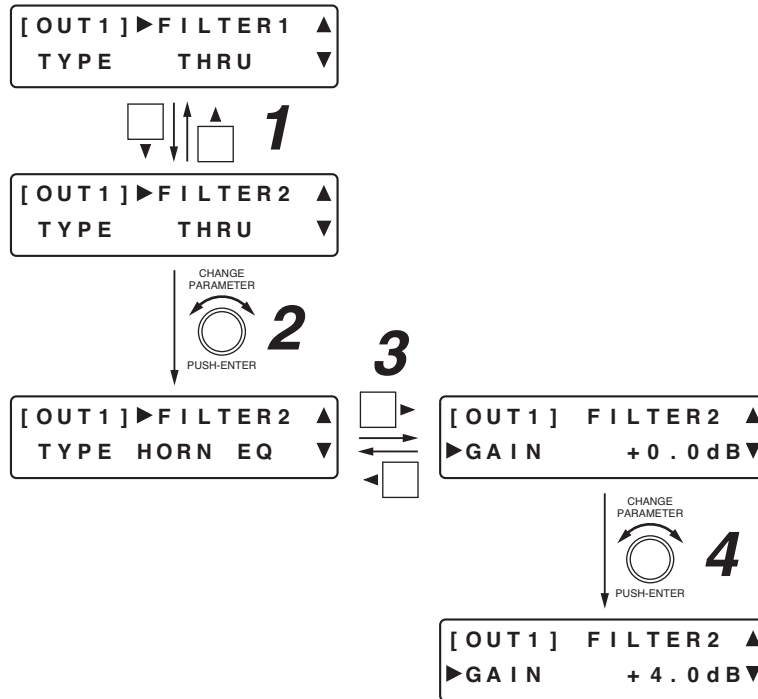

Step 1. Press the ▼ shift key to display a filter.

Step 2. Rotate the Setting knob to select the type of filter.

Step 3. Press the ► shift key to display the setting items for the selected filter.

Step 4. Rotate the Setting knob to set the parameters for each item.

Step 5. Repeat **Steps 3** and **4** when there are two or more setting items.

9.4.1. Parametric equalizer



- Rotate the Setting knob to select PEQ and enter the Parametric Equalizer setting screen.
- Pressing an Output channel selector key permits the filter to be set for that channel. The [OUT 1] indication changes to the selected channel number indication.
- The setting screen reverts to the Input/Output Gain Setting screen when the ◀ shift key is pressed.

[Gain settings]



- Rotate the Setting knob to set the gain.
Parameter setting range: -15 to +15 dB in 0.1 dB steps
- Pressing an Output channel selector key permits the filter to be set for that channel. The [OUT 1] indication changes to the selected channel number indication.

[Center frequency settings]



- Rotate the Setting knob to set the center frequency.
Parameter setting range: 20 Hz – 20 kHz in 1/24 octave steps
- Pressing an Output channel selector key permits the filter to be set for that channel. The [OUT 1] indication changes to the selected channel number indication.

[Q settings]



- Rotate the Setting knob to set the Q.
Parameter setting range: 0.267 – 69.249 (96 points)
- Pressing an Output channel selector key permits the filter to be set for that channel. The [OUT 1] indication changes to the selected channel number indication.

9.4.2. High-pass filter



- Rotate the Setting knob to select either HPF-6 dB or HPF-12 dB and enter the High-Pass Filter setting screen.
The indications of 6 dB and 12 dB represent the slope: 6 dB/oct and 12 dB/oct, respectively.
- Pressing an Output channel selector key permits the filter to be set for that channel. The [OUT 1] indication changes to the selected channel number indication.
- The setting screen reverts to the Input/Output Gain Setting screen when the ◀ shift key is pressed.

[Cutoff frequency settings]



- Rotate the Setting knob to set the cutoff frequency.
Parameter setting range: 20 Hz – 20 kHz in 1/24 octave steps
- Pressing an Output channel selector key permits the filter to be set for that channel. The [OUT 1] indication changes to the selected channel number indication.

[Q settings]



- The Q setting can only be performed when HPF-12 dB is selected.
- Rotate the Setting knob to set the Q.
Parameter setting range: 0.500 – 2.563 (51 points)
- Pressing an Output channel selector key permits the filter to be set for that channel. The [OUT 1] indication changes to the selected channel number indication.

9.4.3. Low-pass filter



- Rotate the Setting knob to select either LPF-6 dB or LPF-12 dB, and enter the Low-Pass Filter setting screen.
The indications of 6 dB and 12 dB represent the slope: 6 dB/oct and 12 dB/oct, respectively.
- Setting items, parameter setting ranges and operations are the same as those for the high-pass filter.

9.4.4. High shelving filter



- Rotate the Setting knob to select H-Shelv and enter the High Shelving Filter setting screen.
- Pressing an Output channel selector key permits the filter to be set for that channel. The [OUT 1] indication changes to the selected channel number indication.
- The setting screen reverts to the Input/Output Gain Setting screen when the ◀ shift key is pressed.

[Gain settings]

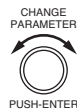

- Rotate the Setting knob to set the gain.
Parameter setting range: –15 to +15 dB in 0.1 dB steps
- Pressing an Output channel selector key permits the filter to be set for that channel. The [OUT 1] indication changes to the selected channel number indication.

[Roll-off frequency settings]



- Rotate the Setting knob to set the roll-off frequency.
Parameter setting range: 6 – 20 kHz in 1/24 octave steps
- Pressing an Output channel selector key permits the filter to be set for that channel. The [OUT 1] indication changes to the selected channel number indication.

9.4.5. Low shelving filter



- Rotate the Setting knob to select L-Shelv and enter the Low Shelving Filter setting screen.
- Setting items and operations are the same as those for the high shelving filter.
- Parameter setting range
Gain: –15 to +15 dB in 0.1 dB steps
Roll-off frequency: 20 – 500 Hz in 1/24 octave steps

9.4.6. Horn equalizer



- Rotate the Setting knob to select HORN EQ and enter the Horn Equalizer setting screen.
- Pressing an Output channel selector key permits the filter to be set for that channel. The [OUT 1] indication changes to the selected channel number indication.
- The setting screen reverts to the Input/Output Gain Setting screen when the ◀ shift key is pressed.

[Gain settings]



- Rotate the Setting knob to set the gain.
Parameter setting range: 0 to +18 dB in 0.5 dB steps
- Pressing an Output channel selector key permits the filter to be set for that channel. The [OUT 1] indication changes to the selected channel number indication.

9.4.7. Notch filter



- Rotate the Setting knob to select NOTCH and enter the Notch Filter setting screen.
- Pressing an Output channel selector key permits the filter to be set for that channel. The [OUT 1] indication changes to the selected channel number indication.
- The setting screen reverts to the Input/Output Gain Setting screen when the ◀ shift key is pressed.

[Center frequency settings]



- Rotate the Setting knob to set the center frequency.
Parameter setting range: 20 Hz – 20 kHz in 1/24 octave steps
- Pressing an Output channel selector key permits the filter to be set for that channel. The [OUT 1] indication changes to the selected channel number indication.

[Q settings]



- Rotate the Setting knob to set the Q.
Parameter setting range: 8.651 – 69.249 (Refer to p. 89 for more information.)
- Pressing an Output channel selector key permits the filter to be set for that channel. The [OUT 1] indication changes to the selected channel number indication.

9.4.8. All-pass filter



- Rotate the Setting knob to select ALL PASS and enter the All-Pass Filter setting screen.
- Pressing an Output channel selector key permits the filter to be set for that channel. The [OUT 1] indication changes to the selected channel number indication.
- The setting screen reverts to the Input/Output Gain Setting screen when the ◀ shift key is pressed.

[Center frequency settings]



- Rotate the Setting knob to set the center frequency.
Parameter setting range: 20 Hz – 20 kHz in 1/24 octave steps
- Pressing an Output channel selector key permits the filter to be set for that channel. The [OUT 1] indication changes to the selected channel number indication.

[Q settings]



- Rotate the Setting knob to set the Q.
Parameter setting range: 0.267 – 69.249 (96 points)
- Pressing an Output channel selector key permits the filter to be set for that channel. The [OUT 1] indication changes to the selected channel number indication.

9.5. Compressor Settings

- ON When any of the following screens is displayed, the compression function for the displayed channel can be enabled or disabled with the function ON/OFF key. When enabled (ON), the function ON/OFF Indicator lights.

[Screen display operations]

Filter settings (P. 45)

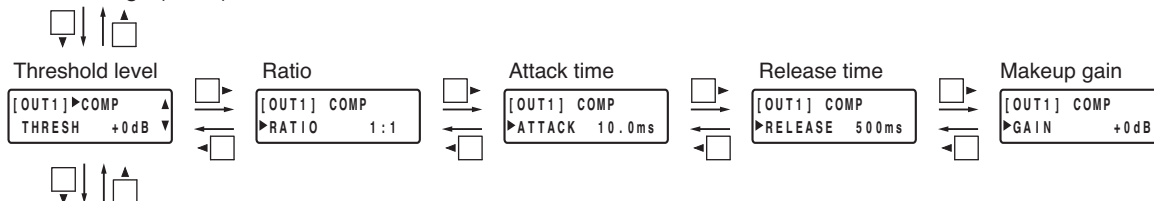

Delay time settings (next page)

9.5.1. Threshold level settings

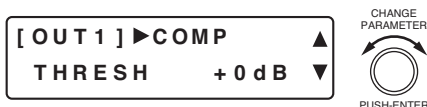

- Rotate the Setting knob to set the threshold level.
Parameter setting range: –20 to +20 dB in 1 dB steps
- Pressing an Output channel selector key permits the compressor threshold level to be set for that channel. The [OUT 1] indication changes to the selected channel number indication.
- The setting screen reverts to the Input/Output Gain Setting screen when the ◀ shift key is pressed.

9.5.2. Ratio settings

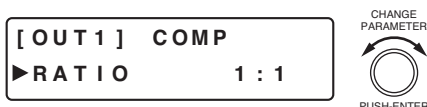

- Rotate the Setting knob to set the ratio.
Parameter setting range: 1:1, 2:1, 3:1, 4:1, 8:1, 12:1, 20:1, INF (∞):1
- Pressing an Output channel selector key permits the compression ratio to be set for that channel. The [OUT 1] indication changes to the selected channel number indication.

9.5.3. Attack time settings



- Rotate the Setting knob to set the attack time. Parameter setting range: 0.2 ms – 5 s (Refer to p. 87 for more information.)
- Pressing an Output channel selector key permits the compressor attack time to be set for that channel. The [OUT 1] indication changes to the selected channel number.

9.5.4. Release time settings



- Rotate the Setting knob to set the release time. Parameter setting range: 10 ms – 5 s (Refer to p. 87 for more information.)
- Pressing an Output channel selector key permits the compressor release time to be set for that channel. The [OUT 1] indication changes to the selected channel number.

9.5.5. Makeup gain settings



- Rotate the Setting knob to set the makeup gain. Parameter setting range: -INF (-∞) to +10 dB in 1 dB steps.
- Pressing an Output channel selector key permits the compression makeup gain to be set for that channel. The [OUT 1] indication changes to the selected channel number.

9.6. Delay Time Settings

Compressor settings
(previous page)

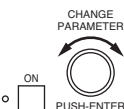
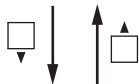

- Rotate the Setting knob to set the delay time. Parameter setting range: 0 – 682.6 ms in 0.021 ms steps
- Press the function ON/OFF key to enable or disable the delay function.
- Pressing an Output channel selector key permits the delay time to be set for that channel. The [OUT 1] indication changes to the selected channel number.
- The setting screen reverts to the Input/Output Gain Setting screen when the ◀ shift key is pressed.

10. MICROPHONE BUS SETTINGS

- SEL The Microphone Bus setting screen is displayed when the Microphone Bus selector key is pressed.

10.1. Feedback Suppression Settings

[Suppressing acoustic feedback with a simple operation]

- Step 1.** Set the volume controls of connected external equipment to the state in which they will actually be used.
- Step 2.** Activate the Auto mode on the Feedback Suppression setting screen. (Refer to the next page.)
All filters (12 bands) that suppress feedback are set after they are initialized.

Notes

- Auto mode cannot be initiated if the number of Auto mode filters is set to 0. (Refer to the next page.)
- Large sounds are produced during Auto mode operation.
- Setting takes about 1.5 minutes. (This may differ depending on the unit installation circumstances.)
- No keys can be used during Auto mode operation. Press the Setting knob to interrupt setup operations.

[Settings to be performed as required]

- Step 3.** Set the Dynamic mode or the number of filters on the Feedback Suppression setting screen, or perform individual settings on the Feedback Suppression Filter setting screen as required.

Notes

- When the number of filters to be used for the Auto and Dynamic modes have been changed, reactivate the Auto mode.
- Take care when executing filter initialization, as feedback may occur.
- It is recommended that the Auto mode be reset when the equalizer setting value has been changed, because the feedback points may change.

[Screen display operations]

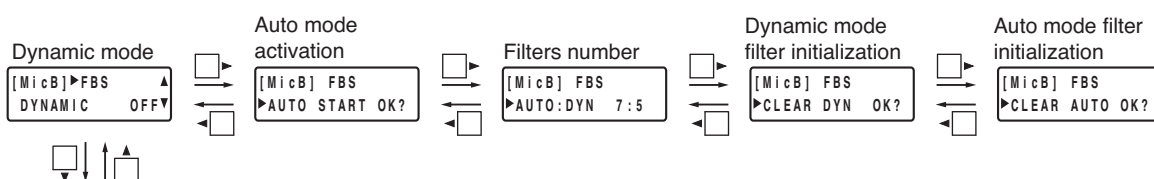

Feedback suppression filter setting confirmation (p. 54)

10.1.1. Dynamic mode settings



- Press the function ON/OFF key to enable or disable the feedback suppression function.
- Enabling the function permits feedback to be suppressed in real time as it occurs. (Dynamic mode)

10.1.2. Auto mode activation



- Press the Setting knob to automatically search for the feedback points and set the filters for feedback suppression. (Auto mode)
- Both the FBS (Feedback suppression) and the LOCK (System lock) indicators flash during Auto mode operation.
- To interrupt the Auto mode operation, press the Setting knob.
- When the number of filters is set to "0" for Auto mode, the indication "Can't use Auto" is displayed on the LCD screen, disabling the Auto mode activation.
- To cancel the function, press the ◀ or ▶ shift key, and the screen changes to display the previous or next setting item.

10.1.3. Filter number settings



- Rotate the Setting knob to set the number of filters to be used for Auto and Dynamic modes.
- Filters are assigned to both modes from 12 filters in total.
- Filters used for Auto and Dynamic modes are assigned to Auto mode followed by Dynamic mode in order of filter number as shown below.

[Example for "AUTO : DYN 7 : 5" (default setting)]

Filter No.	1	2	3	4	5	6	7	8	9	10	11	12
Mode	Auto mode							Dynamic mode				

[Example for "AUTO : DYN 8 : 4"]

Filter No.	1	2	3	4	5	6	7	8	9	10	11	12
Mode	Auto mode								Dynamic mode			

- Even when the number of filters is changed, filters are not initialized.
For example, when filter assignment is changed from "AUTO : DYN 7 : 5" to "AUTO : DYN 8 : 4" (refer to the above setting examples), Filter 8 operation mode is switched to Auto mode, however, keeping the filter parameters once set by Dynamic mode operation.
The Filter parameters and Mode confirmation display (next page) remain unchanged as those for Dynamic mode till Auto mode is activated.

10.1.4. Dynamic mode filter initialization



- All filters set for the Dynamic mode are initialized when the Setting knob is pressed.
- To cancel the function, press the ◀ or ▶ shift key, and the screen changes to display the previous or next setting item.

10.1.5. Auto mode filter initialization



- All filters set for the Auto mode are initialized when the Setting knob is pressed.
- To cancel the function, press the ◀ shift key, and the screen returns to display the previous setting item.

10.2. Feedback Suppression Filter Setting Confirmation

The settings of all 12 Dynamic and Auto mode feedback suppression filters can be quickly confirmed.

[Screen display operations]

Feedback suppression settings (p. 52)

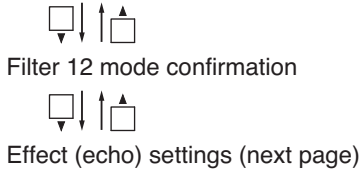
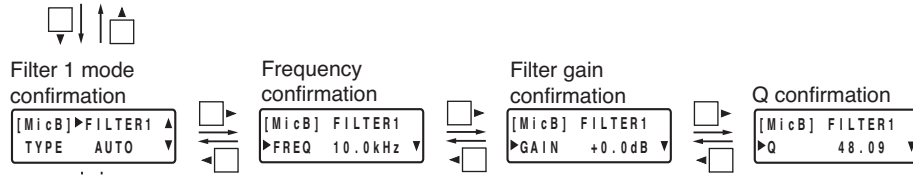

Tip

Feedback suppression filters range from 1 to 12 in number, and the setting items for each filter are the same. Press the ▲ and ▼ shift keys to change the filter number.

10.2.1. Mode confirmation



- The DYN indication is displayed for filters set by the Dynamic mode operation, while the AUTO indication is displayed for filters set by the Auto mode operation, and the "----" indication for filters that are not set.

10.2.2. Frequency confirmation



- Set filter frequencies can be confirmed.

10.2.3. Filter gain confirmation



- Set filter gains can be confirmed.

10.2.4. Q confirmation



- Set filter Q can be confirmed.

10.3. Effect (Echo) Settings

The D-901 has an echo function, a part of an effect function.

- EFFECT
 - The Effect (echo) setting screen can be displayed by pressing the Effect key, or by using the Screen shift keys on the Microphone Bus setting screen.

- ON
 - The effect (echo) function can be enabled or disabled with the function ON/OFF key or Effect key when any of the following screens is displayed.
 - The function ON/OFF and Effect indicators light when enabled (ON).

[Screen display operations]

Feedback suppression filter setting confirmation (previous page)

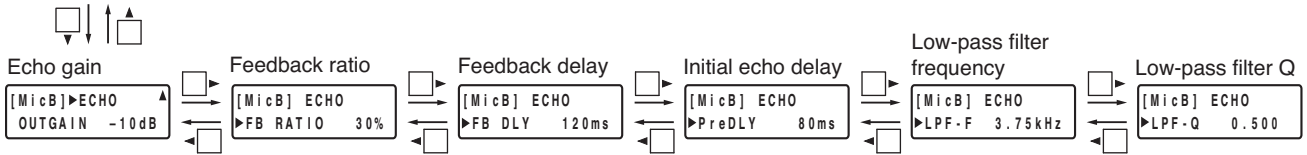

Bus assignment and crosspoint gain settings (next page)

[Effect (echo) function block diagram]

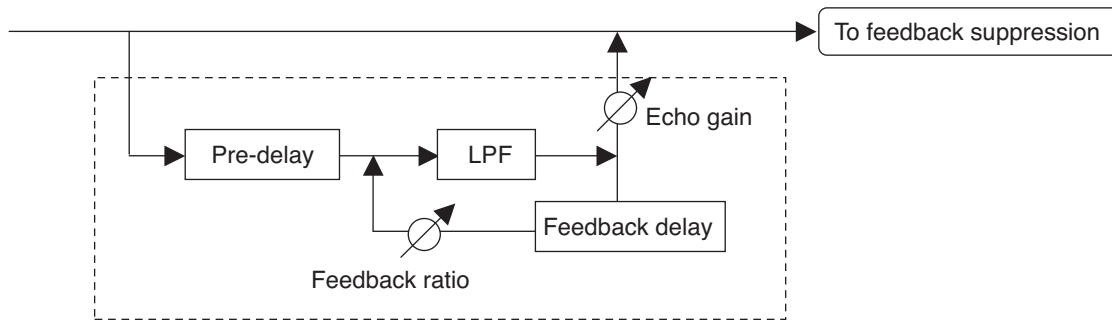

10.3.1. Echo gain settings



- Rotate the Setting knob to set the echo gain.
Parameter setting range: $-\infty$ ($-\infty$) to 0.0 dB in 1 dB steps

10.3.2. Feedback ratio settings



- Rotate the Setting knob to set the feedback ratio.
Parameter setting range: 0 – 99% in 1% steps

10.3.3. Feedback delay settings



- Rotate the Setting knob to set the feedback delay time.
Parameter setting range: 0 – 682 ms

10.3.4. Initial echo (pre-) delay settings



- Rotate the Setting knob to set the initial echo delay time. Parameter setting range: 0 – 682 ms

10.3.5. Low-pass filter frequency settings



- Rotate the Setting knob to set the low-pass filter frequency. Parameter setting range: 20 Hz – 20 kHz

10.3.6. Low-pass filter Q settings



- Rotate the Setting knob to set the low-pass filter Q. Parameter setting range: 0.500 – 2.563 (51 points)

10.4. Bus Assignment and Crosspoint Gain Settings (Microphone Bus → Output Channel)

[Screen display operations]

Effect (echo) settings (previous page)

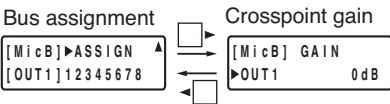
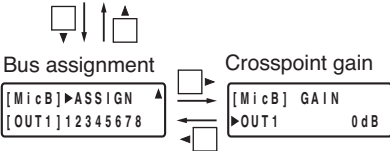

10.4.1. Bus assignment settings

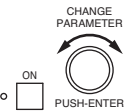

- Rotate the Setting knob to select the output channel bus (1 – 8), then press the function ON/OFF key to enable or disable the assignment. When disabled (OFF), the "-" indication is displayed.
- All buses 1 – 8 are enabled by default.

10.4.2. Crosspoint gain settings

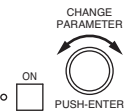

- Rotate the Setting knob to set the crosspoint gain. Parameter setting range: -INF (-∞) to 0 dB in 1 dB steps
- Pressing an Input channel selector key permits the input channel selection.
- Pressing an Output channel selector key permits the Output channel selection.
- Pressing the function ON/OFF key enables or disables the selected assignment.

11. PRESET MEMORY SETTINGS

- PRESET The preset setting screen is displayed when the Preset key is pressed.
-  Pressing the key again exits the preset setting screen in any of the following settings, displaying the Input/Output Gain Setting screen.

11.1. Preset Memory Save

Set parameters can be stored in memory (number of memories: 16).

[Parameters that can be stored in memory]

- Input channel parameters: PAD, Phantom power, Line input mode selection, Line input selection, Input trim gain, Input trim polarity, High-pass filter, Equalizer (low and high frequencies), Compressor/auto-leveler mode selection, Compressor/auto-leveler, Level sense, Gate, Auto-mixing group, Ducker, NOM attenuation ON/OFF, Input channel gain, Channel ON/OFF, Group trim gain, and Bus assignment
- Output channel parameters: Output channel gain, Group trim gain, Channel ON/OFF, Filters 1 – 6 (including crossover), Compressor, and Delay
- Microphone bus parameters: Feedback suppression (Dynamic mode ON/OFF, Filter number, and Filter parameters set in Auto and Dynamic modes), Echo, and Bus assignment
- Others: Stereo link, Group, Crossover configuration, NOM attenuation, and Channel selection status

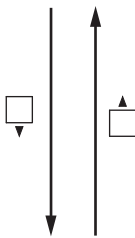

Preset memory recall (next page)

Step 1. Press the ◀ and ▶ shift keys to select the desired preset memory number.

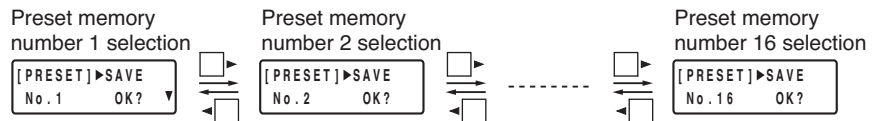

Step 2. Press the Setting knob to execute the function. The indication "Now Saving..." is displayed and saving begins. Saving is completed when the indication turns off.

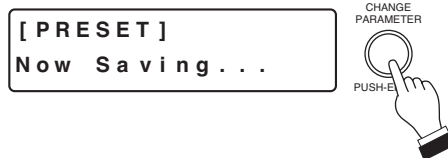

Note: To cancel the function, press the Preset key.

11.2. Preset Memory Recall

Recall the stored preset memory.

Preset memory save
(previous page)

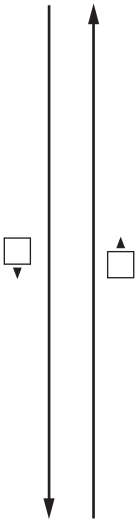
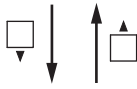

Step 1. Press the ◀ and ▶ shift keys to select the desired preset memory number.

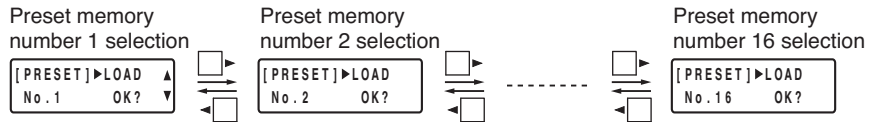

Tip

The screen at left can be recalled for preset memory numbers 1 – 8 by simply pressing the desired Preset Memory selector key, regardless of the currently displayed setting screen. However, the display cannot be switched to another screen by way of the ▲ and ▼ keys.

Step 2. Press the Setting knob to execute the function. The indication "Now Loading..." is displayed and loading begins. Recall is completed when the indication turns off.

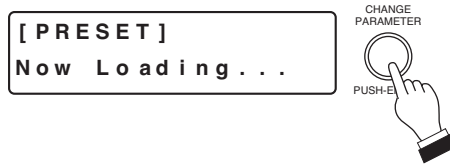

Note: To cancel the function, press the Preset key.

11.3. Preset Memory Delete

Delete the stored preset memory.

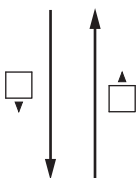

Preset memory crossfade
time settings (next page)

Step 1. Press the ◀ and ▶ shift keys to select the preset memory number to be deleted.

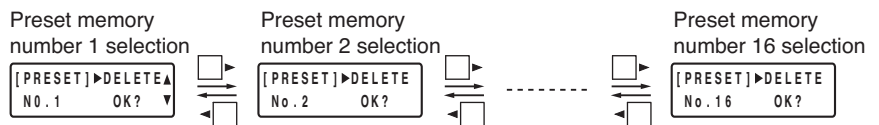

Step 2. Press the Setting knob to execute the function. The indication "Now Deleting..." is displayed and deletion begins. Deletion is completed when the indication turns off.

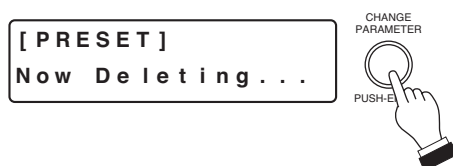

Note: To cancel the function, press the Preset key.

11.4. Preset Memory Crossfade Time Settings

Set the crossfade time when the currently selected preset memory is switched over to a newly recalled one by pressing the preset memory number.

[Parameters to be cross-faded]

Input/output channel gains, channel ON/OFF, bus assignment, cross-point gains.

Parameters other than those above instantaneously switch when the preset memory is recalled.

Note

When the currently selected preset memory is switched over to a newly recalled one, the channels of which phantom power ON/OFF, PAD, line input mode, and line input selection have been changed are muted for a specified period of time.

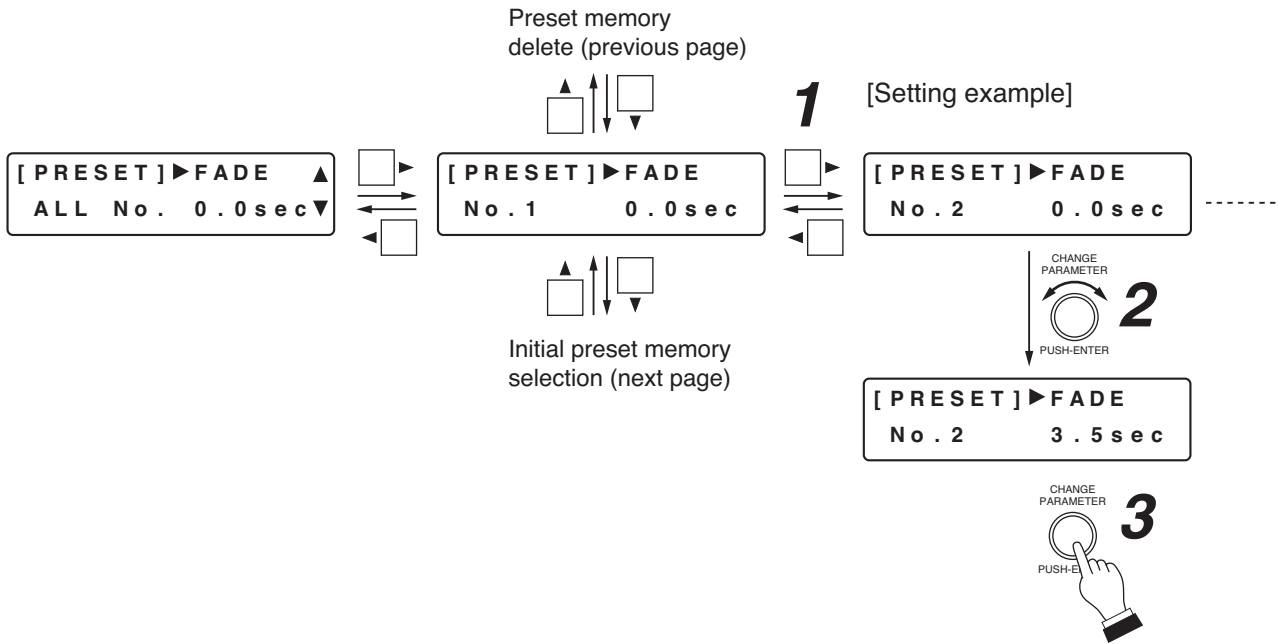

Step 1. Press the ◀ and ▶ shift keys to select the desired preset memory number.

Note

On the [All No.] screen, crossfade time of all memories can be set at a time.

The following screen appears when each memory setting is different.



Step 2. Rotate the Setting knob to change the crossfade time.

Parameter setting range: 0.0 – 10.0 s, 0.5 s steps

Tips

- Saving the configuration (see the next page) causes the parameters to be cross-faded to change at the set crossfade time.
- Configuration can also be saved by pressing the Setting knob on this screen.
- To cancel the function, press the Preset key.

11.5. Initial Preset Memory Selection

Select the preset memory number (1 – 16) or LAST MEMORY to be automatically recalled when the power is switched on.

Preset memory crossfade time settings (previous page)

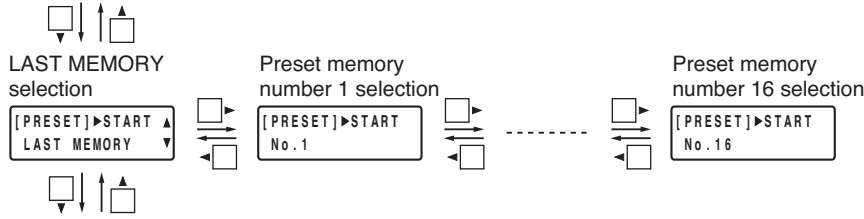

Configuration Save (next section)



- Press the ◀ and ▶ shift keys to select the desired preset memory number to be automatically recalled when the power is switched on.
- Setting the LAST MEMORY permits the preset memory number recalled last before the unit's power-off to be automatically recalled at the power-on.

Note

The preset memory is set to LAST MEMORY by default, and the preset memory No.1 is recalled.

- Performing the Configuration Save (next item) allows the selected memory number to be saved as a preset memory number recalled at unit's power-on operation. Be sure to perform the Configuration Save after changing the preset number selection.
- The Configuration save can also be executed by pressing the Setting knob at this screen.
- To cancel the function, press the Preset key.

11.6. Configuration Save

Preset memory crossfade time settings (previous section)

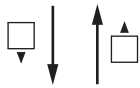

- Pressing the Setting knob saves the settings for the Preset Memory Crossfade Time, the Contact Input/Output functions, Protect function, and Initial preset memory.
- To cancel the function, press the Preset key.

12. UTILITY SETTINGS

UTILITY The utility setting screen is displayed when the Utility key is pressed.



12.1. Stereo Link Settings

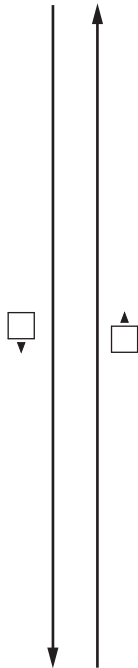

- Rotate the Setting knob to select the channels to be "Stereo-Linked."
- Press the function ON/OFF key to enable or disable the Stereo-Link setting.

[Setting example]



Note

The output channel that is enabled for crossover function - a parameter except "NONE" is set - in the Crossover Configuration Settings (p. 62) is displayed on the screen as follows, not being set as a "Stereo-Linked" channel.



- The following "Stereo-Linked" channel parameter settings are synchronized:
 Input channel: PAD, Phantom power, Input trim gain, High-pass filter, Parametric equalizer, Compressor/auto-leveler*, Gate*, Auto-mixing group, Ducker, NOM attenuation ON/OFF, Input channel gain, Channel ON/OFF, and Group settings
 Output channel: Output channel gain, Filters 1 – 6 (including crossover), Compressor*, Delay, and Group settings
 * Operations are also synchronized.

Tip

When the input channel and the output channel are both set for Stereo Link, the bus assignment setting is also synchronized. (Refer to p. 41.)

12.2. Group Settings

By grouping multiple channels together, the gains of these channels can be simultaneously adjusted using the Input or Output volume control.

Step 1. Rotate the Setting knob to display the channels to be grouped in the [] area on the lower row.

Step 2. Press the ► shift key.

Stereo Link setting (above item)

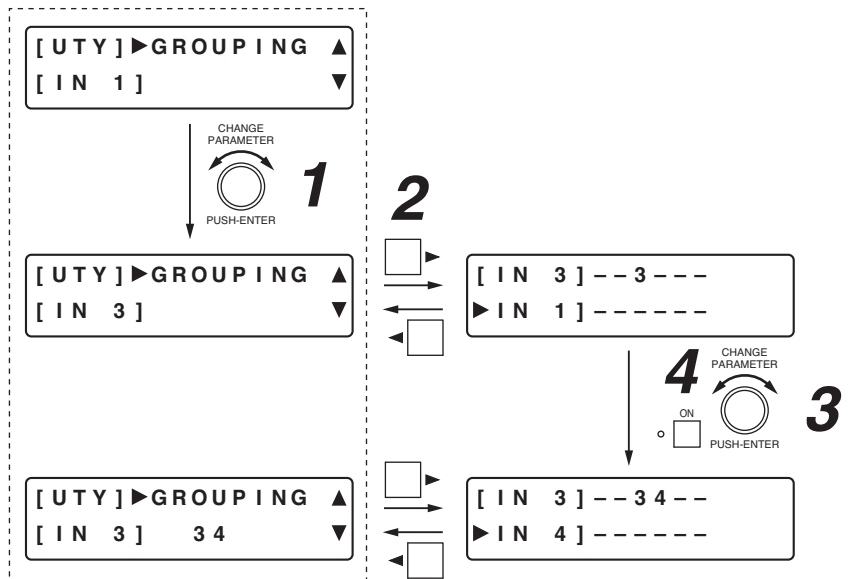

Crossover configuration (high frequency) settings (next page)

Step 3. Rotate the Setting knob to select the channels to be grouped together with the channels displayed in the [] area on the upper row.

(The selected channels are displayed in the " ►]" area on the lower row.

Step 4. Press the function ON/OFF key to confirm the selected channels.

All of the channels set for grouping are displayed on the upper row at the right.

Note

When group settings are performed, the offset gain between the channels in the [] area on the upper row and the selected channels are set as the selected channels' group trim value. Therefore, after grouping, the fader gain is the same if the channels grouped together are within the same group.

Tip

The channels set for grouping are displayed on the lower row at the right when the ► shift key is pressed to revert to the initial Group setting screen.

12.3. Crossover Configuration Settings

Enable or disable the Crossover function. When enabling, set the crossover filter's maximum slope as well. When enabled, the Crossover setting screen is displayed on the Output setting screen, depending on setting contents. (Refer to p. 43.) Also, the number of filters to be displayed on the Filter setting screen (p. 45) used in the output settings changes depending on the setting contents.

Note

The "Stereo-Linked" (p. 61) output channel will not use the crossover function. That output channel is displayed on the screen as shown at right, being made invalid for the crossover configuration setting.

(High frequency)

```
[ UT Y ] X O V E R - H F
[ O U T 1 ]   - - - -
```

(Low frequency)

```
[ UT Y ] X O V E R - L F
[ O U T 1 ]   - - - -
```

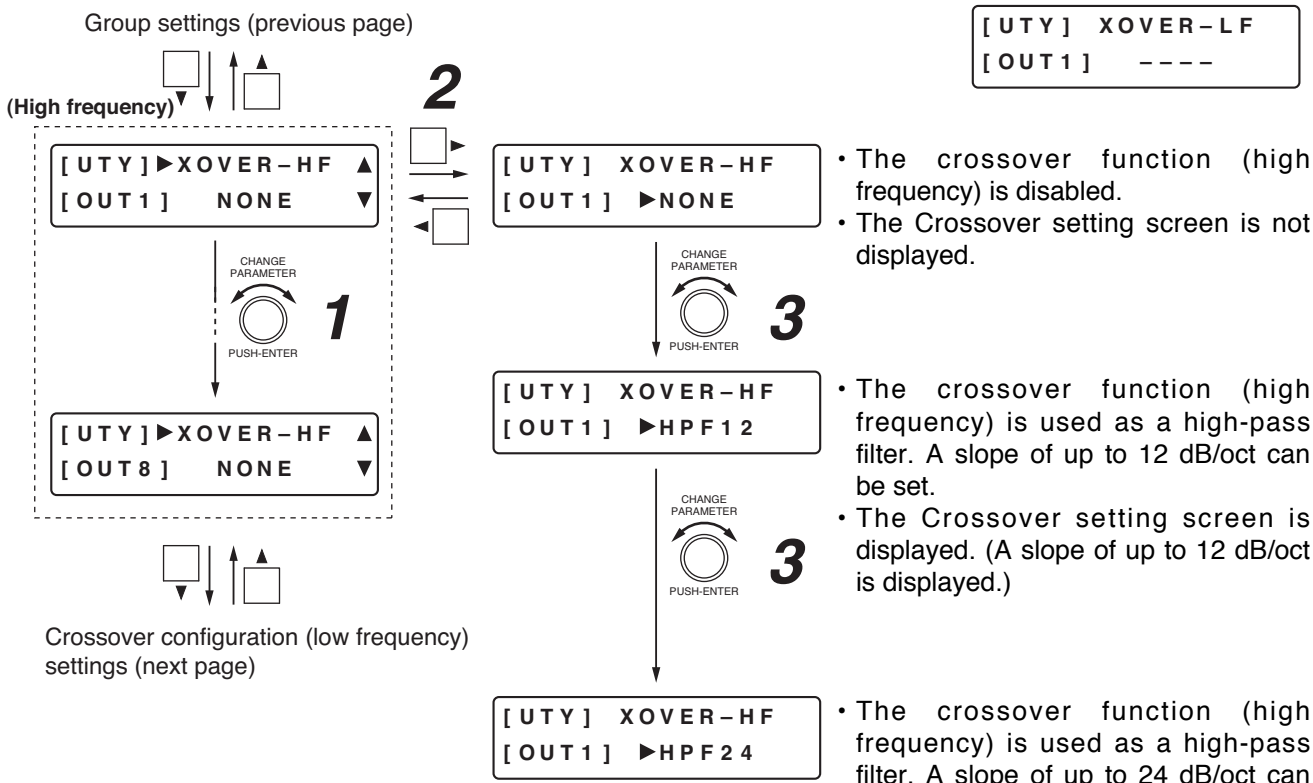

Step 1. Rotate the Setting knob to display the channel to be set in the [] area on the lower row.

Step 2. Press the ► shift key.

Step 3. Rotate the Setting knob to enable or disable the crossover function.

Crossover configuration
(high frequency) settings
(previous page)

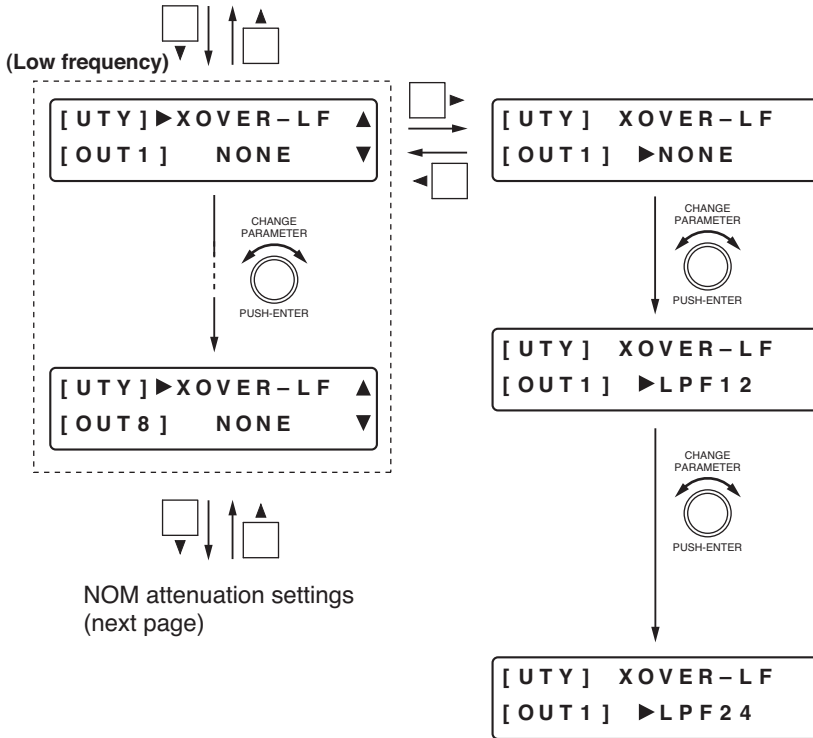

- The crossover function (low frequency) is disabled.
- The Crossover setting screen is not displayed.

- The crossover function (low frequency) is used as a low-pass filter. A slope of up to 12 dB/oct can be set.
- The Crossover setting screen is displayed. (A slope of up to 12 dB/oct is displayed.)

- The crossover function (low frequency) is used as a low-pass filter. A slope of up to 24 dB/oct can be set.
- The Crossover setting screen is displayed. (A slope of up to 24 dB/oct is displayed.)

Note

The setting method is the same as that used for the crossover configuration (high frequency).

Number of filters usable for the Filter settings

The settings above determine the number of filters to be displayed on the Filter setting screen (p. 45) as follows:

XOVER-L Setting \ XOVER-H Setting	NONE	HPF12	HPF24
NONE	6	5	4
LPF12	5	4	3
LPF24	4	3	2

12.4. NOM Attenuation Settings

NOM is an acronym of Number of Open Microphones, and represents the number of microphones in open status (the number of input channels with open gates).

The NOM attenuation function automatically adjusts the open microphone's input channel gain depending on the number of open microphones. The open microphone channel gain is attenuated by the gain set on the following setting screen each time the number of open microphones doubles. The use of this function allows an output level to be kept constant, thus helping to prevent feedback. Set each input channel to enable or disable this function. (Refer to p. 39.)

This function operates in each of the auto-mixing groups, GROUP A through D (p. 37).

[Screen display operations]

Crossover configuration (low frequency) settings (previous page)

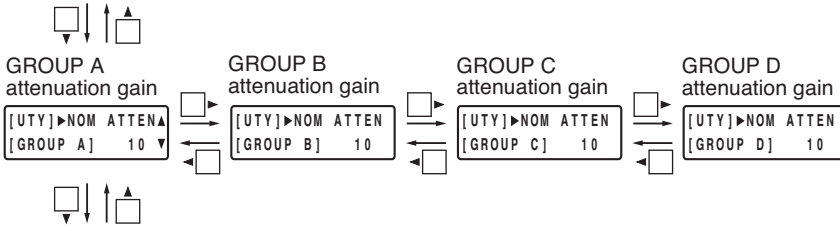

When using the D-981, D-983, or D-984VC: Contact input/output settings (next page)

When not using the D-981, D-983, or D-984VC: Protect settings (p. 68)



- Rotate the Setting knob to set the attenuation gain for each group.
Parameter setting range: 0 – 20 (0 \log_{10} NOM – 20 \log_{10} NOM)

12.5. Contact Input/Output Settings (Available only when D-981, D-983, or D-984VC is used)

Many different functions assigned to the input and output contacts of the D-981 or D-983 Remote Control Module, or the D-984VC VCA Control Module can be remotely controlled by connected external equipment. Use the Setting knob to select the functions to be assigned.

Notes

- To make subsequent settings valid when the power is ON after the initial Contact input/output settings, save the configuration (p. 60). Settings are saved as system data, and setting status is maintained even if the preset memory is recalled.
- Configuration can also be saved by pressing the Setting knob at this screen.

12.5.1. Function assignment to the input contact

Each of the following functions can be assigned to input contacts (1 – 8 when the D-981 or D-984VC is used, and 1 – 24 when the D-983 is used).

Preset memory recall, Input and output channel volume adjustment, Channel ON/OFF setting, and Line (stereo) input selection

[Screen display operations]

NOM attenuation settings (previous page)

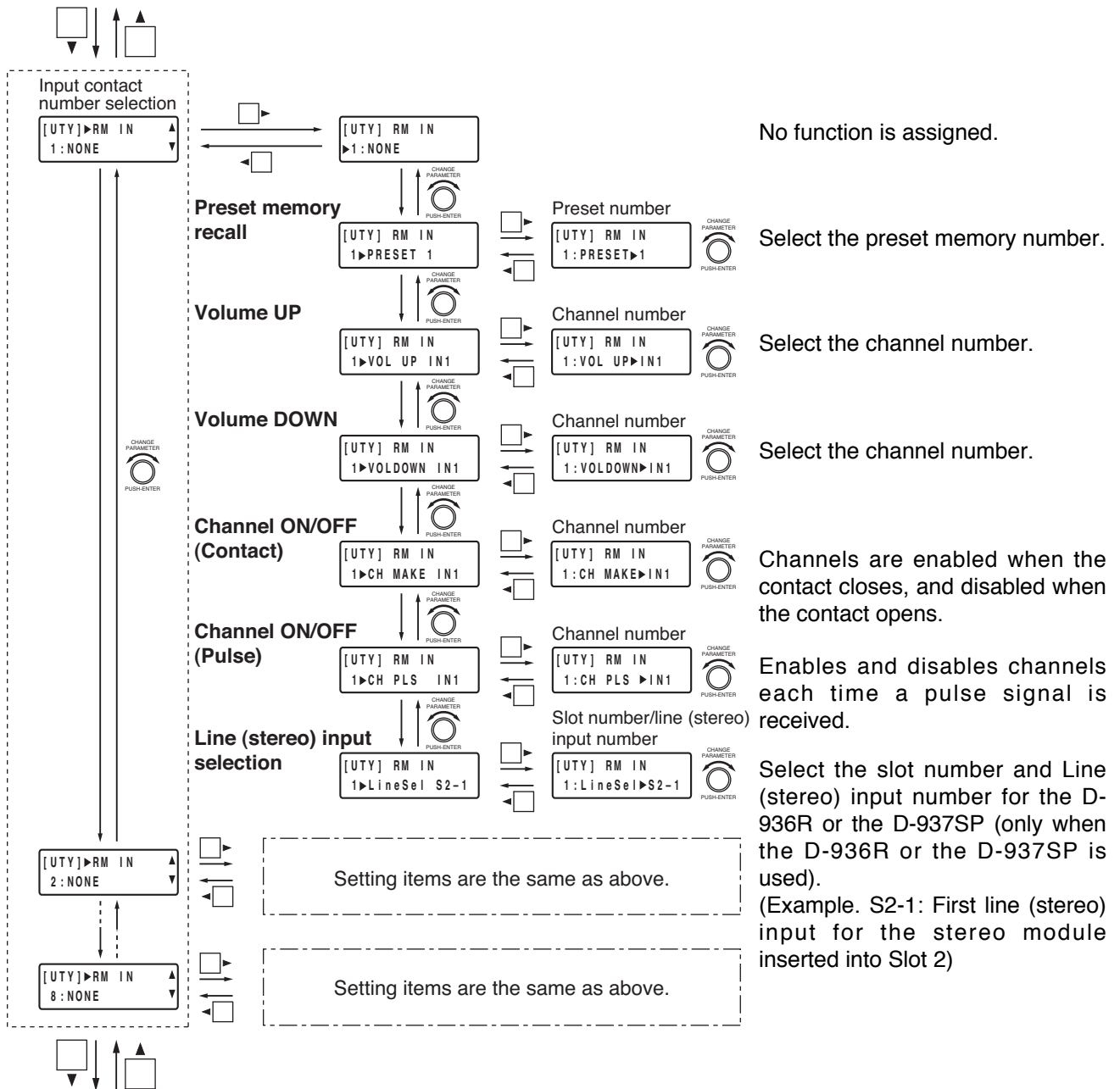

No function is assigned.

Select the preset memory number.

Select the channel number.

Select the channel number.

Channels are enabled when the contact closes, and disabled when the contact opens.

Enables and disables channels each time a pulse signal is received.

Select the slot number and Line (stereo) input number for the D-936R or the D-937SP (only when the D-936R or the D-937SP is used).

(Example. S2-1: First line (stereo) input for the stereo module inserted into Slot 2)

Output contact number selection (p. 67)

[Setting Procedures (Example. Assigning Preset Memory 3 recall to Contact Input 2)]

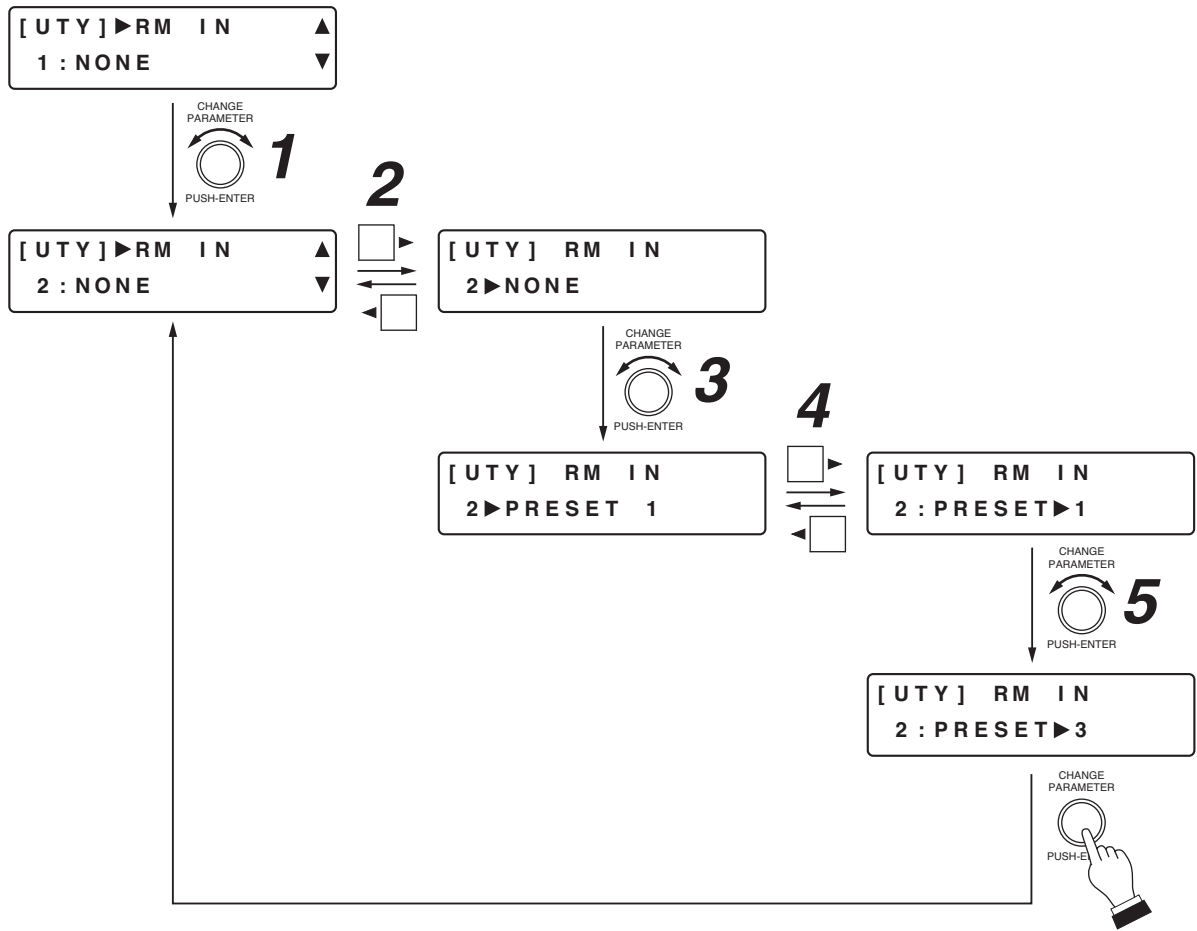

Step 1. Rotate the Setting knob to select the input contact number.

Step 2. Press the ▶ shift key.

Step 3. Rotate the Setting knob to select the function to be assigned to the contact input.

Step 4. Press the ▶ shift key.

Step 5. Rotate the Setting knob to select the setting contents for each function.

Tip

Pressing the Setting knob executes the Configuration save and allows the display to revert to the Input contact number selection screen.

12.5.2. Function assignment to the output contact

The following functions can be assigned to output contacts (1 – 8 when the D-981 or D984-VC is used, and 1 – 16 when the D-983 is used).

Preset memory recall tally, Channel ON/OFF tally, Contact input status tally, and Line (stereo) input selection tally

The procedures for assigning functions are the same as those used when assigning functions to the input contacts.

[Screen display operations]

Input contact number selection (p. 65)

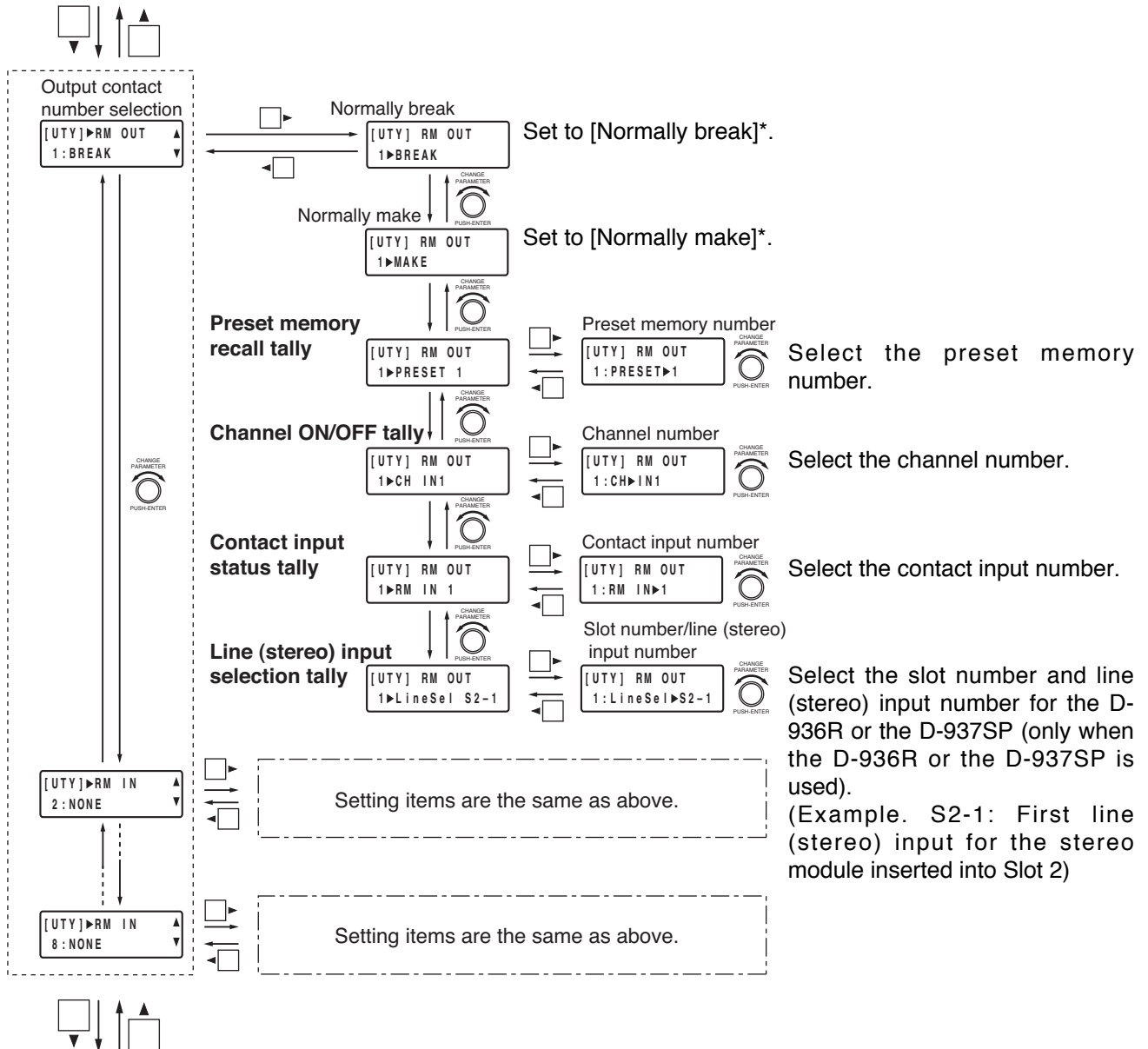

Protect settings (next page)

* Normally break: Turning on the power sets the contact output to "break."
Normally make: Turning on the power sets the contact output to "make."

Note: All contact outputs are at break while the power is off.

12.6. Protect Settings

Operation misses can be avoided by protecting front panel-mounted key operations.

Tips

- To make subsequent protections valid when the power is ON after the initial Protect function settings, save the configuration (p. 60). (However, if the Protection function is enabled in the way described below, the configuration save needs not be performed because the latest configuration including the Protection function settings are automatically saved at the moment of the key operation.) Settings are saved as system data, and setting status is maintained even if the preset memory is recalled.
- Control operations can be performed either by way of the RS-232C port or the remote control module even when in protection mode.
- Configuration can also be saved by pressing the Setting knob at this screen.

When using the D-981, D-983, or D-984VC:

Contact input/output settings (p. 65)

When not using the D-981, D-983, or D-984VC:

NOM attenuation settings (p. 64)

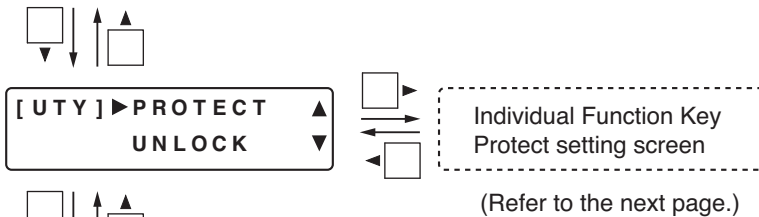

RS-232C port settings (p. 70)

- Confirm protect status.
UNLOCK: Disables the Protect function. The Protect function can be set while unlocked.
LOCK: Enables the Protect function, and validates the Protect function settings.

[Enabling and disabling the Protect function]

Press the Setting knob while holding down the Utility key to enable the Protect function and lock the system. (The System Lock indicator lights.) To release the lock and disable the Protect function, press the Setting knob again while holding down the Utility key. (The System lock indicator extinguishes.)

Note

Both the system lock and unlock operations automatically save the configuration.

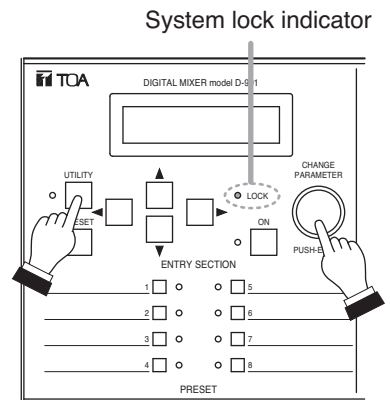

[Keys that can be protected]

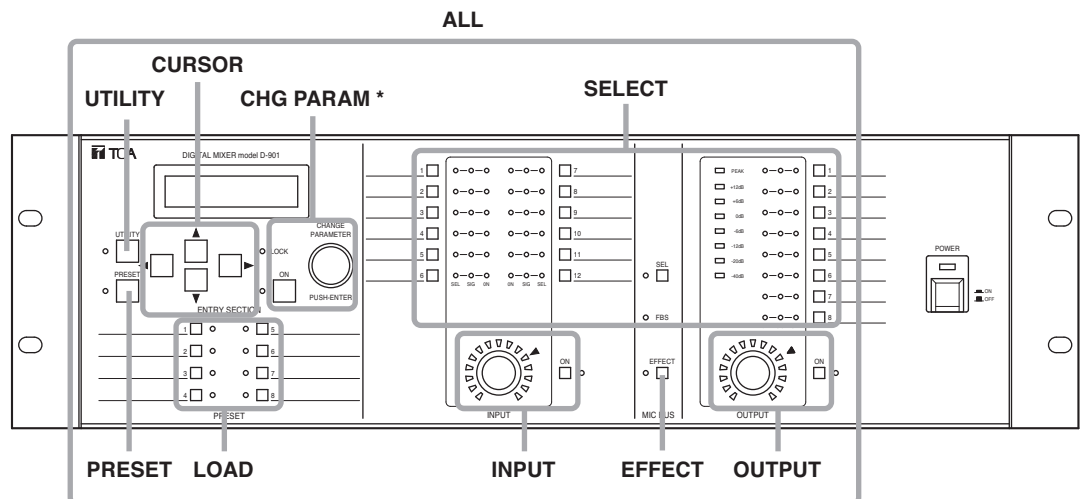

* Bus assignment operations by way of the Input and Output channel selector keys are also locked and disabled.

- Rotate the Setting knob to select the key(s) to be protected.
- The Protect function can be enabled or disabled for the selected key(s) by pressing the function ON/OFF key.



- Enables or disables the Protect function for all keys.
- ON: Simultaneously enables the Protect function for all keys.
- : Enables the Protect function for a part of keys.
- OFF: Simultaneously disables the Protect function for all keys.



- Enables or disables the Protect function for the Utility key.
- When enabled (ON), the Utility function cannot be set.



- Enables or disables the Protect function for the Preset key.
- When enabled (ON), the Preset Memory function cannot be set using the Preset key. (Preset memory can be recalled using the Preset memory selector keys.)



- Enables or disables the Protect function for the Setting knob, the Function ON/OFF key, and bus assignment operation by way of the Input and Output channel selector keys.
- When enabled (ON), parameters cannot be set.



- Enables or disables the Protect function for the Screen shift keys.
- When enabled (ON), screen displays cannot be changed with the shift keys.



- Enables or disables the Protect function for the Preset memory selector keys (1 – 8).
- When enabled (ON), preset memory cannot be recalled using the Preset memory selector keys. (Preset function can be set using the Preset keys.)



- Enables or disables the Protect function for the Input volume control and the Input channel ON/OFF key.
- When enabled (ON), the input volume cannot be adjusted with the Input volume control, and the input channels cannot be enabled or disabled.



- Enables or disables the Protect function for the Output volume control and the Output channel ON/OFF key.
- When enabled (ON), the output volume cannot be adjusted with the Output volume control, and the output channels cannot be enabled or disabled.



- Enables or disables the Protect function for the Input channel selector keys, the Output channel selector keys, and the Microphone bus selector key.
- When enabled (ON), the selector keys cannot be used.



- Enables or disables the Protect function for the Effect key.
- When enabled (ON), the Effect key cannot be used.

12.7. RS-232C Port Settings

[Screen display operations]

Protect settings (p. 68)

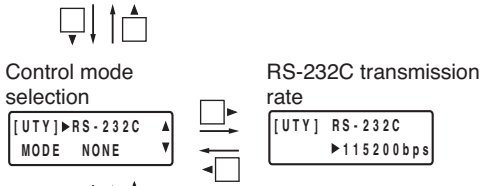

All input/output channel gain confirmation (next page)

Tip

Settings are automatically saved as system data, and setting status is maintained even if the power is turned off.

12.7.1. Control mode selection



- Rotate the Setting knob to select the mode that matches the type of equipment connected to the unit's RS-232C port.
 - UPDATE: A PC is connected to update the unit's firmware using the utility program. (Refer to p. 75.)
 - REMOTE: A conventional remote controller (AMX, Crestron, etc.) is connected.
 - PC CTRL: A PC is connected to control the unit using the dedicated setting software program (to be downloaded from our International site, see below).

Tips

- While the D-901 is communicating with a PC, the front-mounted system lock indicator flashes.
- In the above status, attempting to change settings with the front-mounted knobs or keys notifies the operator of prohibited operation by way of the indication shown below.

```
PC Control Mode
***Key Locked***
```

- To enforce the termination of communications with the PC, press the Setting knob holding down the Function ON/OFF key.
- The control protocol and setting software program are available for download at our website: <http://www.toa-products.com/international/>

12.7.2. RS-232C transmission rate settings

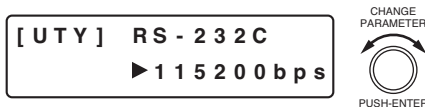

- Rotate the Setting knob to set the RS-232C transmission rate. Parameter setting range: 115200, 38400, 19200, 9600 bps

12.8. All Input/Output Channel Gain Confirmation

RS-232C port settings (previous page)

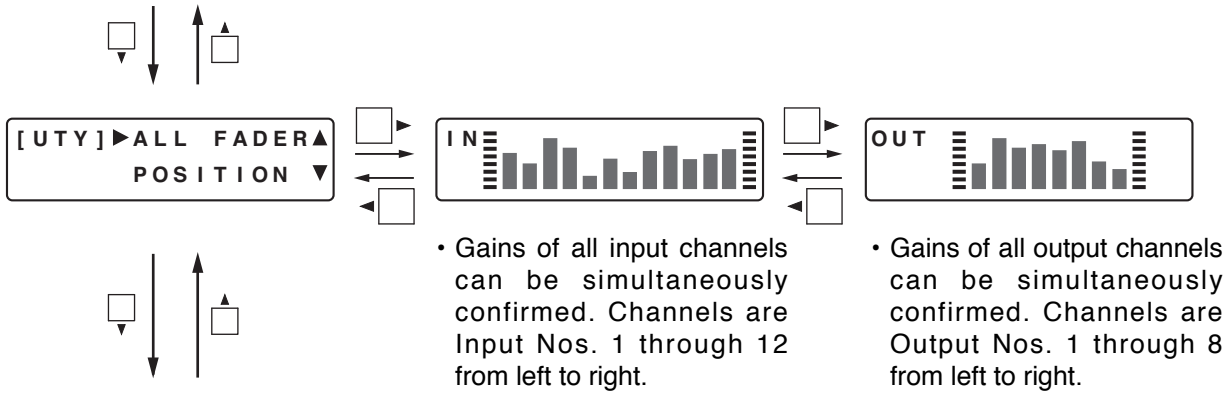

12.9. All Input/Output VCA Status Confirmation (Only when the D-984VC is used)

All input/output channel gain confirmation (previous section)

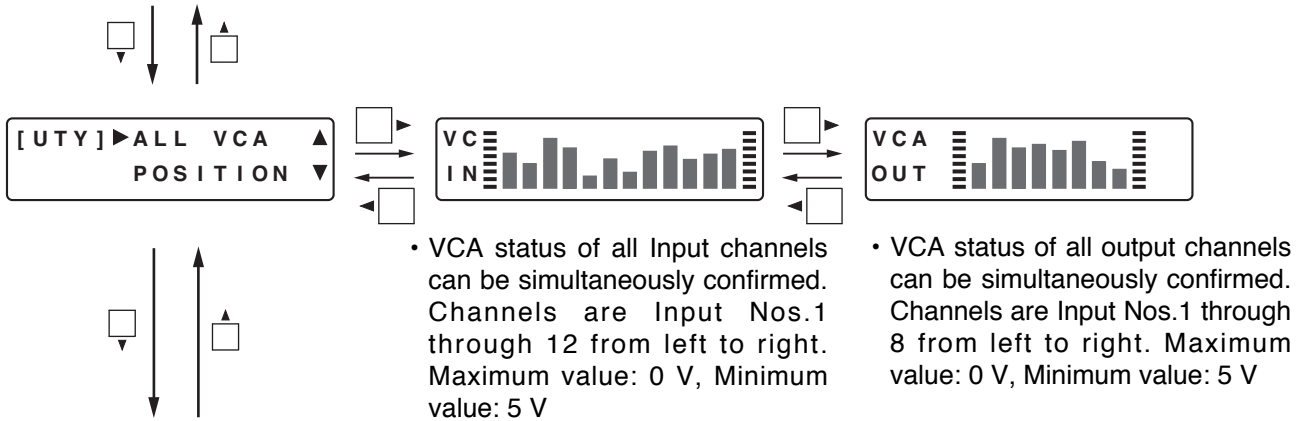

Module type confirmation (next page)

Note

The above screens show the statuses of VCA input and output terminals. When channels are set for the stereo link or group, all their gains change synchronizing with the lowest numbered channel's gain. Irrespective of these settings for channels, the VCA statuses are displayed for individual channels as shown above.

12.10. Module Type Confirmation

Types of modules installed in the unit's rear slots can be confirmed.

[Screen display operations]

All input/output channel gain confirmation (previous section)

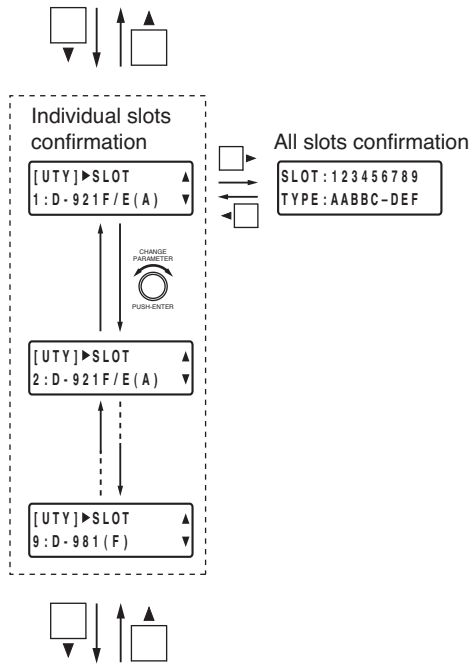

Cooling fan operation status confirmation (next page)

12.10.1. Individual slots confirmation



- Rotate the Setting knob to confirm the type of module installed in each slot.
- The slot number and installed module type are displayed on the lower row.

The module types are as follows:

- D-921F or D-921E: D-921F/E (A)
 - D-923AE: D-923AE (I)
 - D-922F or D-922E: D-922F/E (B)
 - D-937SP: D-937SP (J)
 - D-936R: D-936R (C)
 - D-961SP: D-961SP (K)
 - D-971M or D-971E: D-971M/E (D)
 - D-972AE: D-972AE (L)
 - D-971R: D-971R (E)
 - D-983: D-983 (M)
 - D-981: D-981 (F)
 - D-984VC: D-984VC (N)
 - No module installed: BLANK (–)
- For the slot where a wrong module is inserted (for example, an output module is inserted into an input slot), "(*)" is displayed.

12.10.2. All slots confirmation

```
SLOT : 1 2 3 4 5 6 7 8 9
TYPE : A A B B C - D E F
```

- Slot numbers are displayed on the upper row, and the inserted module types on the lower row.

- A: D-921E or D-921F Microphone/line input module
- B: D-922E or D-922F Microphone/line input module
- C: D-936R Stereo input module
- D: D-971E or D-971M Line output module
- E: D-971R Line output module (RCA connector)
- F: D-981 Remote control module
- I: D-923AE Digital input module
- J: D-937SP Digital input module
- K: D-961SP Digital output module
- L: D-972AE Digital output module
- M: D-983 Remote control module
- N: D-984VC VCA control module
- : Blank
- *: A wrong module installed

- When a wrong module is inserted into a slot, the initial screen that indicates the relevant slot with "*" mark appears after the unit's power is switched ON as shown below.

```
*** ERROR ***
CHECK SLOT
```

12.11. Cooling Fan Operating Status Confirmation

Module type confirmation (previous page)

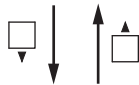

```
[ UTY ] ► FAN ▲
          RUNNING ▼
```

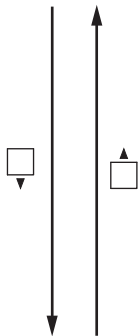

- The operating status of the rear-mounted cooling fan can be confirmed on the screen.

Normal operation:

```
[ UTY ] ► FAN ▲
          RUNNING ▼
```

Operation failure:

```
[ UTY ] ► FAN ▲
          WARNING ▼
```

- When "ERROR" is displayed, check to be sure that the fan exhaust vent is not blocked or that a foreign object has not jammed the vent. The fan is detected as having failed when it stops or if its rotation speed is extremely slow. In such cases contact your TOA dealer.
- If the fan rotation speed decreases dramatically, the display switches over to the cooling fan failure screen even when another screen is displayed. Pressing the Setting knob turns off the failure indication.

12.12. Firmware Version Confirmation

```
[ UTY ] ► VERSION ▲
          3 . 0 0 . 0 0 0
```

- The firmware version number can be confirmed.

13. RESTORING FACTORY DEFAULT SETTINGS

Perform the following procedure to reset all parameters to the factory default settings.

Step 1. Turn the power switch OFF.

Step 2. Turn the power switch ON while holding down both the ◀ and ▶ shift keys. Keep pressing both keys until "[SYSTEM] Initialize OK?" is displayed on the LCD screen.

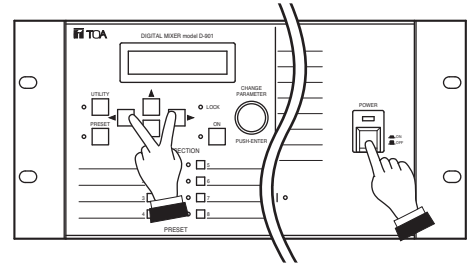

Step 3. Press the Setting knob.

The LCD screen display changes to "[SYSTEM] Initializing...". Then, all parameters are reset to the factory default settings, and the Input/Output Gain Setting screen is displayed.

Note

The factory default Bus Assignment setting is made so that each input (1 – 12) is assigned to all outputs (1 – 8) via the Microphone Bus. Other default parameters are shown on p. 87 – 90.

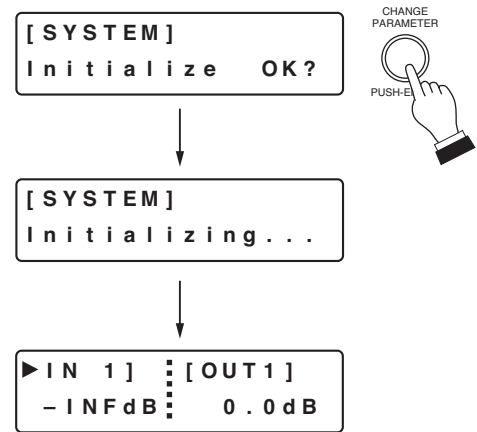

14. FIRMWARE UPDATE

The D-901's firmware can be updated using the software program (D901PCvxxx_fxxx.exe)*¹ made available on the TOA internet site [http://www.toa-products.com/]. To update the firmware, download the software program to install it into your PC. (For the installation procedure, refer to the "D901 PC Software Instruction Manual" also available on the same site.)

The firmware update is performed by using the D-901 Firmware Update Utility program simultaneously installed with the D-901 PC Software.

Follow the procedure for the firmware update below.

After updating the firmware, use the latest D-901 instruction manual that can also be downloaded from the website above.

*¹ The software version number can be confirmed at the xxx indication. For example when the PC Software version is 3.00 and Firmware version is 3.01, it is indicated as "D901PCv300e_f301.exe".

Step 1. Connect both RS-232C ports of the D-901 and the PC using a 9-pin straight cable (male-to-female cord).

Step 2. Make RS-232C port settings at the D-901.

Set the control mode to "UPDATE"^{*2} and the transmission rate to "115200 bps" (recommended). (Refer to p. 70.)

*² Set "NONE" for the version 1.xx firmware.

Step 3. Select the menu items [Start → Program → TOA Digital Audio Control → Update D-901 Firmware]. The D-901 Firmware Update screen appears.



The default communication settings are as follows:

Communication port: COM 1

Baud rate: 115200 bps

Unless otherwise necessary to change, follow **Step 6**.

To change the settings, follow **Step 4**.

Step 4. Click the Comm Settings button.

The Comm Settings screen appears.

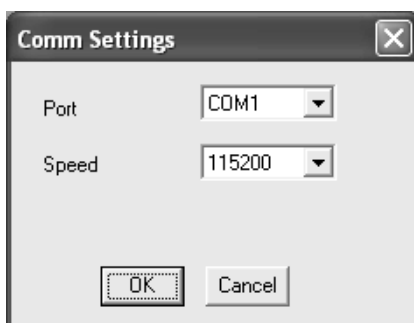

Step 5. Set the PC's Com port the D-901 is connected to, and the Speed (baud rate*) equal to the D-901's RS-232C transmission rate.

Click OK, then the Comm Settings screen closes.

* Set the same value as that set in **Step 2**.

Step 6. Click the Update button of the D-901 Firmware Update screen.

The firmware update starts being transferred from the PC to the D-901.

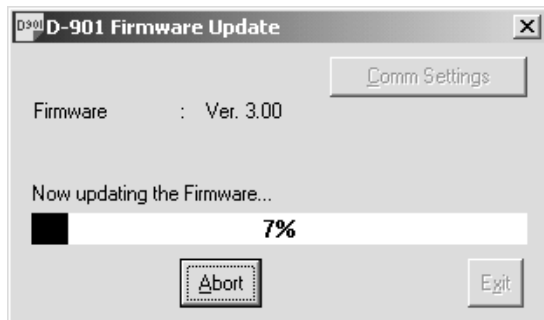

The following screen appears after the update ends.

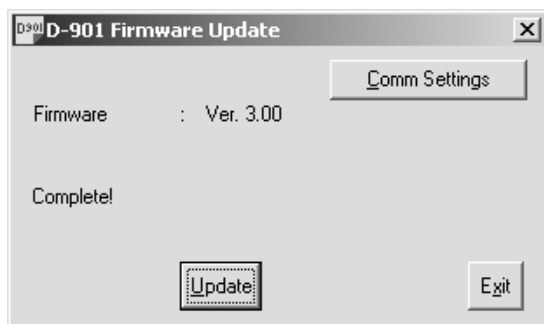

[If "No Reply" is displayed]

If the screen on the right appears after clicking the Update button, confirm the following:

- RS-232C cable specification and connection
Check that 9-pin straight cable (male - female) is used.
- RS-232C settings at the D-901 (p. 70)
Check that the control mode is set to UPDATE*.
* Set "NONE" for the version 1.xx firmware.
- PC communication settings (above on this page)

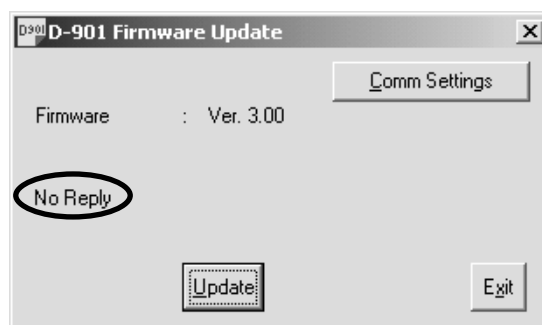

After confirming all the above items, follow the procedure from **Sep 3** again.

If the same "No Replay" indication still appears in this **Step 6**, turn the D-901's power off, and on again. Then, follow the steps again from the beginning.

Step 7. Turn the D-901's power off, and on again.

Confirm the firmware version number that appears on the LCD screen at the unit's power-on. When the new version number is indicated, update has been completed correctly.

Using the Utility key can also indicate the firmware version number on the LCD screen. (Refer to p. 73.)

[If an error indication appears on the D-901's LCD screen] (See the screens below.)

Click the Update button of the D-901 firmware update screen, and "Complete!" is displayed on its screen. Then, the error indication disappears.

After confirming its disappearance, restart the procedure from **Step 2** without turning the D-901's power off.

```
<<SYSTEM ERROR>>  
TYPE : f f 0 0
```

or

```
<<SYSTEM ERROR>>  
TYPE : f f 0 1
```

Step 8. Click the Exit button to end the firmware update.

15. RACK MOUNTING

Mount the unit in an equipment rack using the supplied rack-mounting screws and fiber washers.

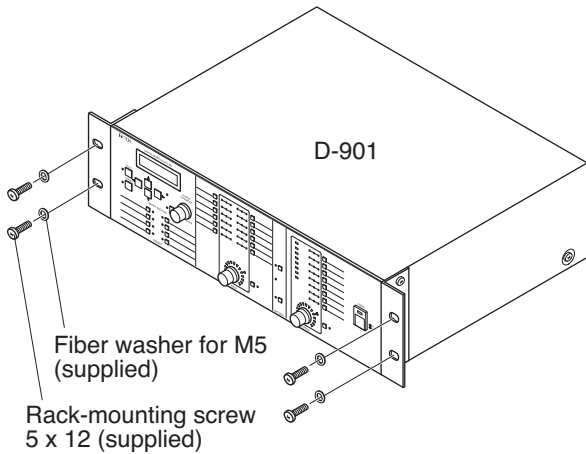

Note
The supplied rack mounting screws are special screws for the TOA equipment rack. They cannot be used for other racks.

Cautions

- Install the unit as far as possible away from amplifiers or other equipment that generate heat.
- The socket-outlet shall be installed near the equipment and the plug (disconnecting device) shall be easily accessible.
- When installing the unit in an equipment rack, pay attention not to block the ventilation slots on the unit's bottom. It is recommended that a Perforated panel of over 1-unit in size be mounted directly below the unit as shown below.

Attentions

- Installer l'appareil aussi loin que possible des amplificateurs ou autres équipements générant de la chaleur.
- La prise doit être installée à proximité de l'équipement et la fiche (dispositif de déconnexion) doit être facilement accessible.
- Lors de l'installation de l'appareil en bâti, veiller à ne pas obstruer les événements de ventilation sur le dessous. Il est recommandé de monter un panneau perforé plus grand que l'appareil directement sur ce dernier, comme indiqué ci-dessous.

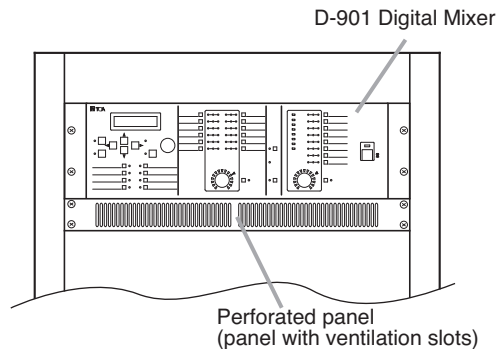

16. CONNECTIONS

16.1. Connection Example 1

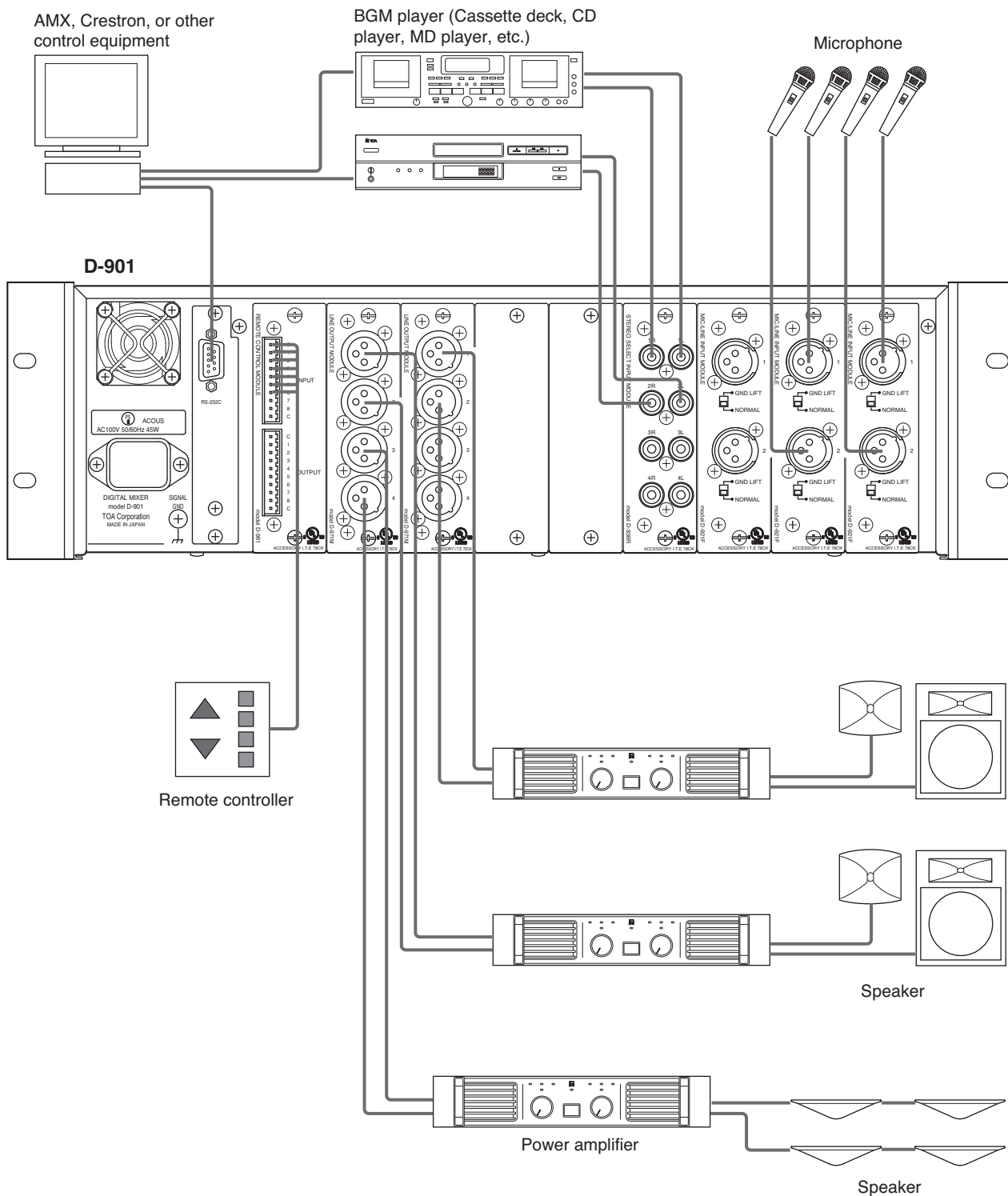

16.2. Connection Example 2 (Broadcasting to two separate zones)

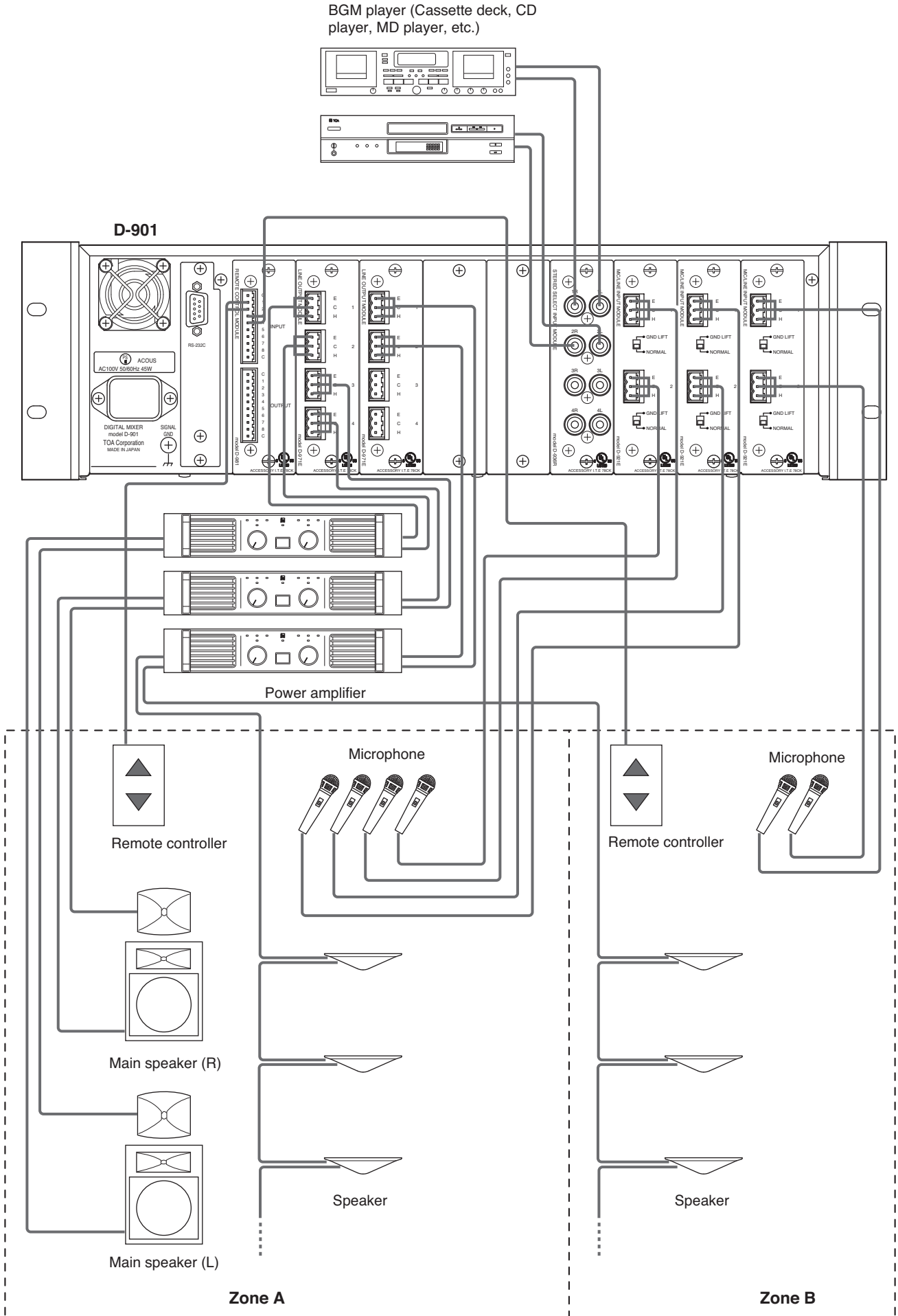

16.3. Removable Terminal Plug Connection

Cautions

- Be sure to use shielded cables for audio signal lines.
- Avoid soldering stranded or shielded cable, as contact resistance may increase when the cable is tightened and the solder is crushed, possibly resulting in an excessive rise in joint temperatures.

Cable end treatment

Solid or stranded cable

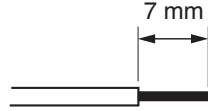

Shielded cable

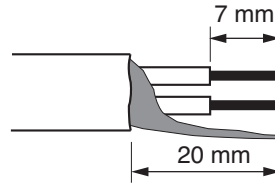

Connector connections

- Step 1.** Detach the unit's rear-mounted input/output connector (removable terminal plug) from the unit.
- Step 2.** Loosen the terminal screw, then insert the cable.
- Step 3.** Retighten the terminal screw. (Pull on the cable to ensure it is securely connected.)
- Step 4.** Remount the input/output connector to the unit.

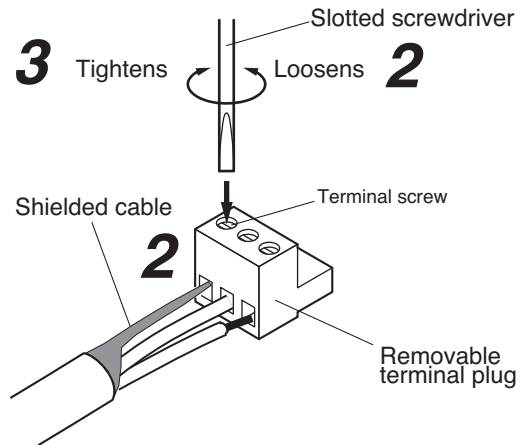

Tip

Recommended slotted screwdriver type: Screwdriver with blade that is 3 mm in width

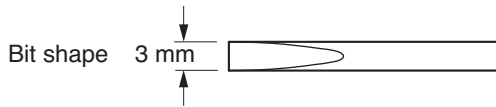

16.4. Ferrite Cable Clamp Attachment (For D-972AE only)

To reduce electromagnetic noise, place the supplied ferrite clamp over each digital output cable when making a cable connection to the D-972AE Digital Output Module.

Install one ferrite clamp per digital output cable.

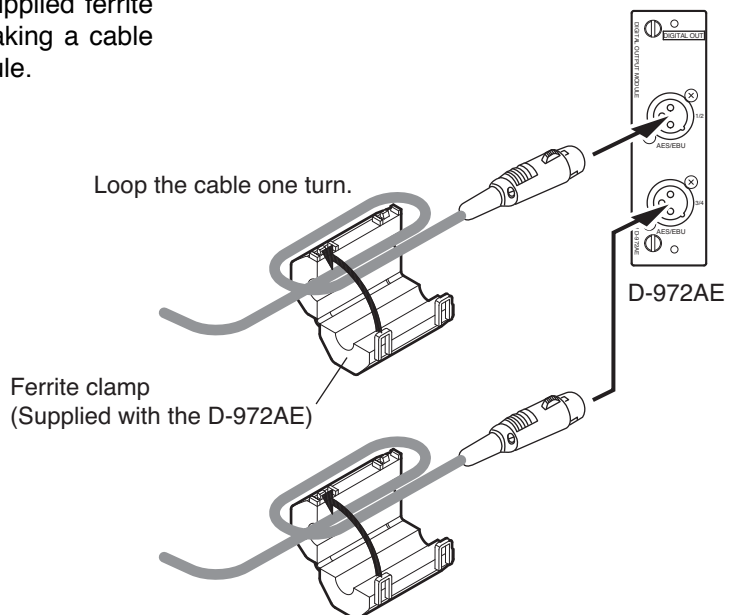

16.5. Connections of the D-984VC

The optional VCA Fader Unit D-911 can remotely control the VCA Control Module D-984VC. However, You can make a special unit having the same functions as the D-911 referring to the technical information described here.

16.5.1. Connecting to the D-984VC

- For connecting to each terminal, use a CAT5 (Category 5) UTP cable fitted with a RJ45 connector.

Note

Use a STP cable in an environment where the cable is susceptible to noises.

- Maximum cable length is 100 m.
- Pin arrangement of the D-984VC's terminals

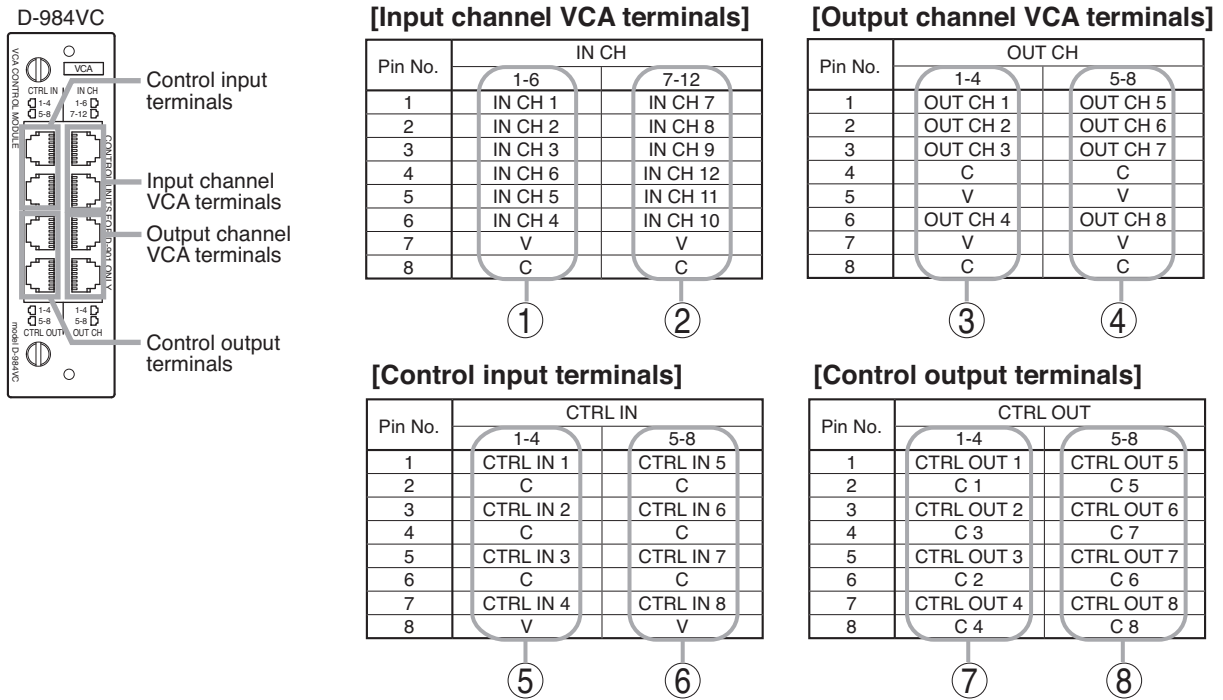

16.5.2. Input and output channel VCA controls (1) – (4)

- With 5 V at an input channel VCA pin (IN CH 1 – 12) or at an output channel VCA pin (OUT CH1 – 8), the corresponding channel's sound volume is minimum. With 0 V, the sound volume is at the level set by the D-901.
- Use 10 kΩ potentiometers of taper B.
- Up to 6 volume controls can be connected to each V pin.

[Connections to the input channel VCA terminal]

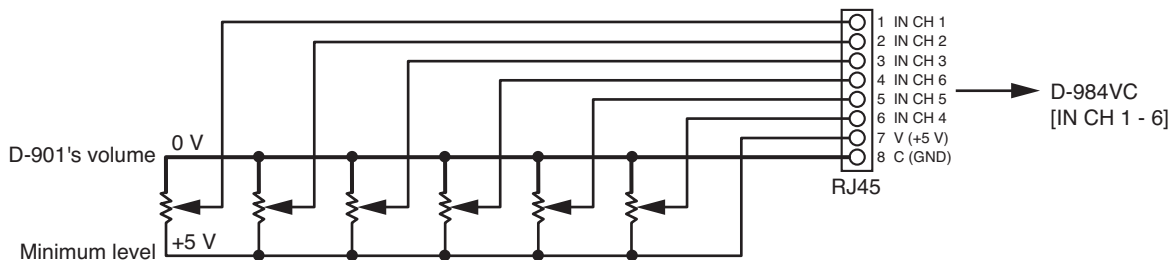

[Connections to the output channel VCA terminal]

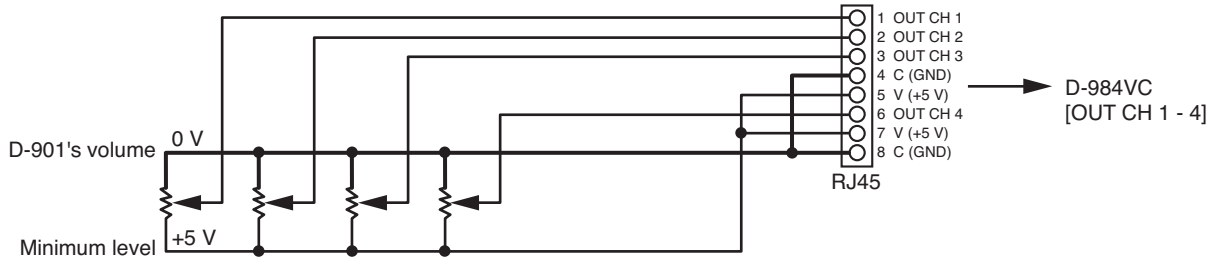

16.5.3. Contact controls (5) – (8)

- Preset memory recall function is assigned to the contact input and output pins at the factory. To change this function assignment to give channel ON/OFF or line input selection, refer to p. 69.
- The V pins of the control input terminals can be used for LED connections. To do this, connect the contact COM pins to use out of the C1 – 4 pins of the control output (7) or the C5 – 8 pins of the control output (8) to the C pins of the control input (5) or (6). (The diagram below is an example where the control output's C1 – 4 pins are connected to the control input's C pins.)

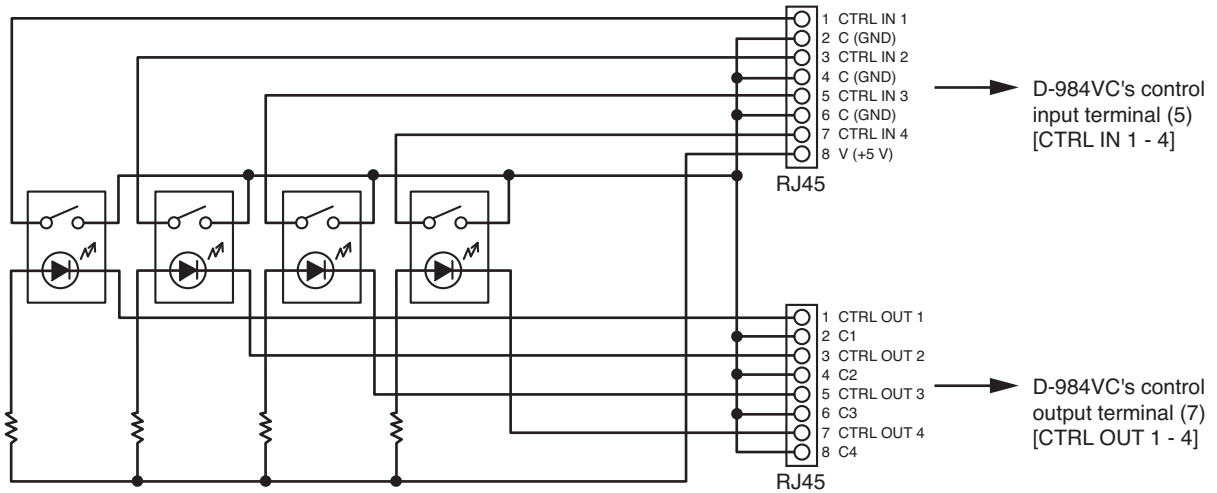

- The current capacity is 40 mA per V pin. When more current is needed, connect a power supply separately as shown below.

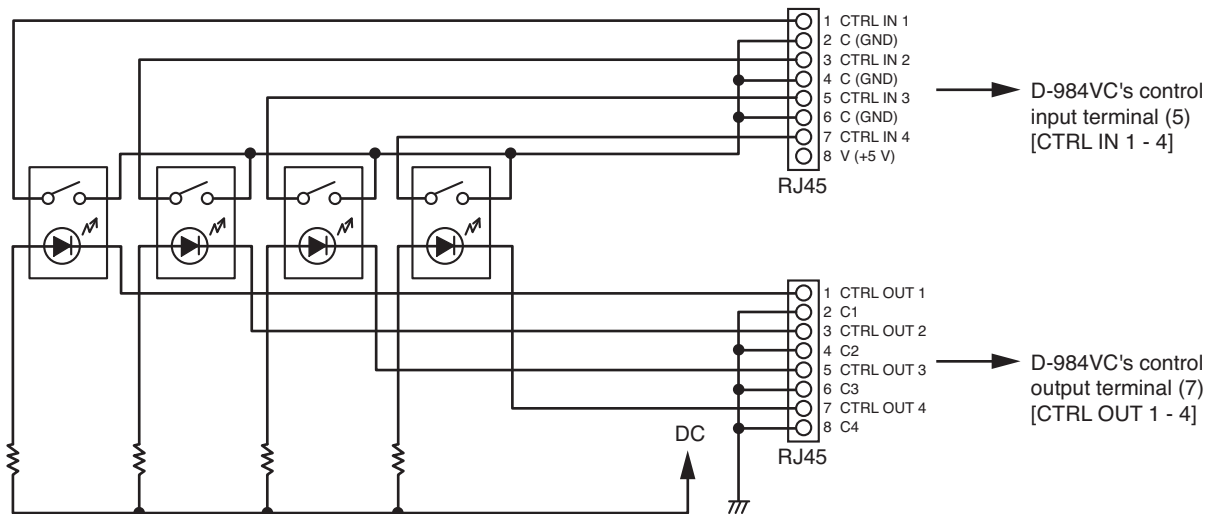

- Never connect the V pins of control inputs (5) and (6) to the V pins of VCA pins (1) – (4) as the sound volume may be affected due to voltage drop caused by these connections.

17. BLOCK DIAGRAM

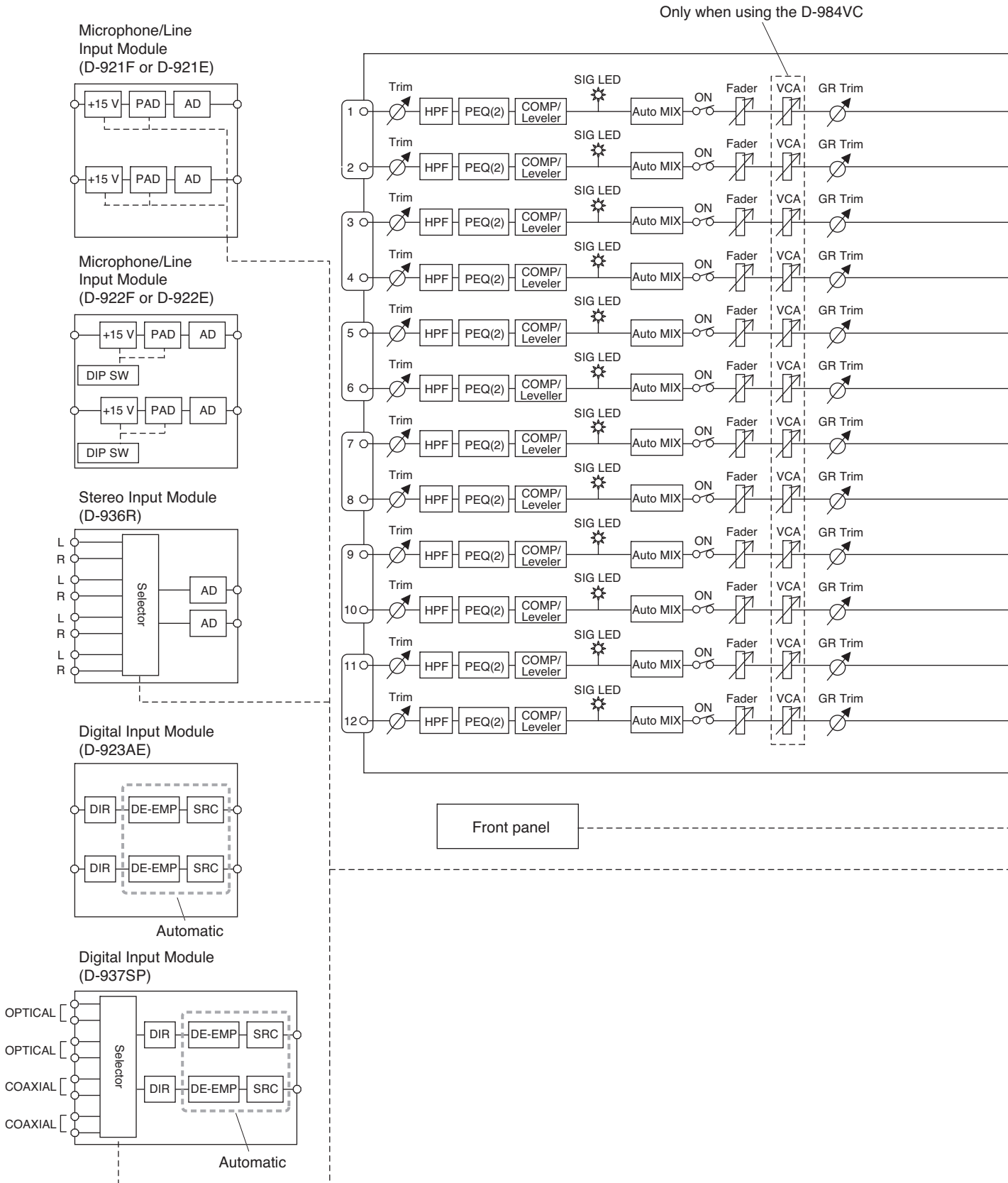

Only when using the D-984VC

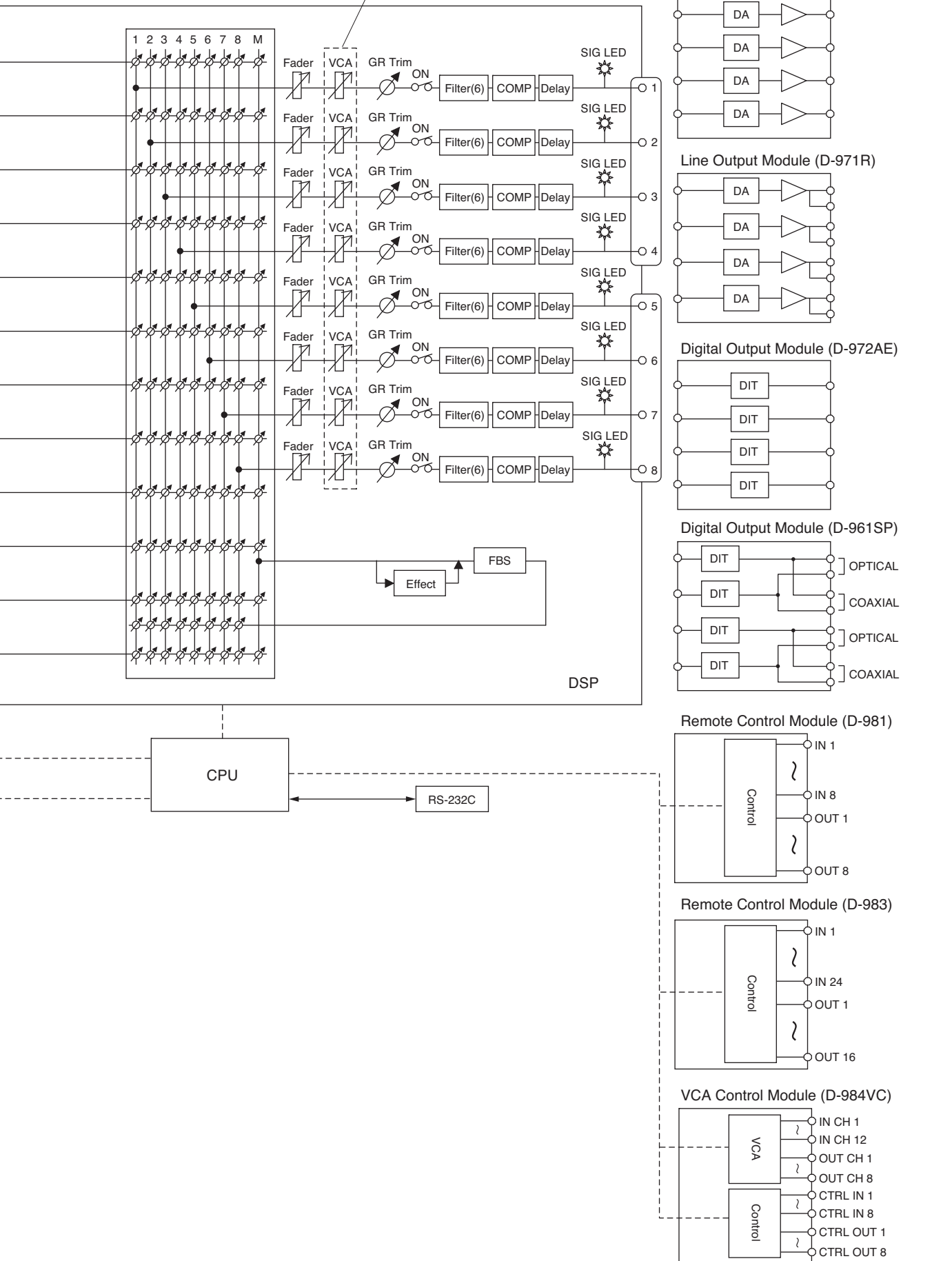

18. LEVEL DIAGRAMS

18.1. Analog Input/Output

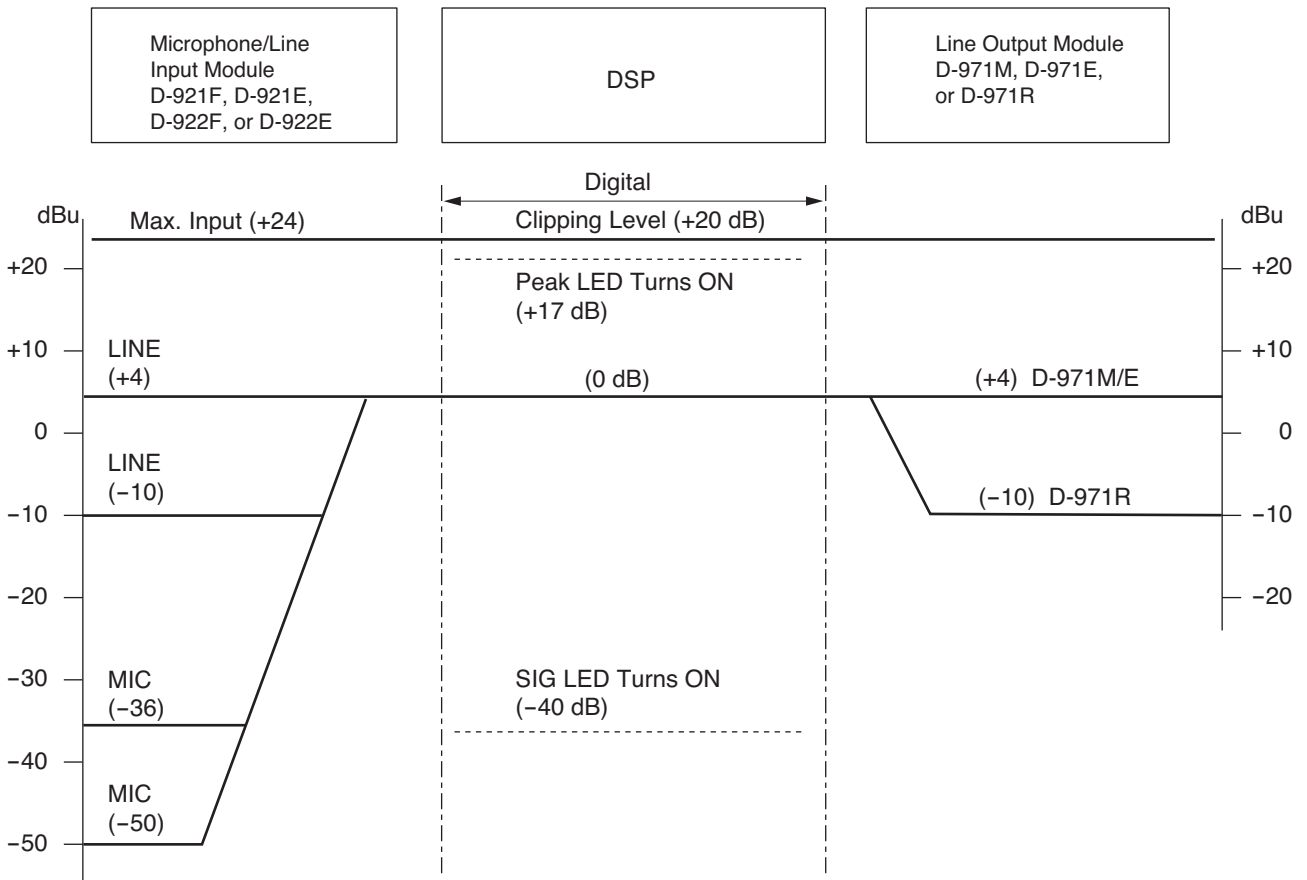

18.2. Digital Input/Output

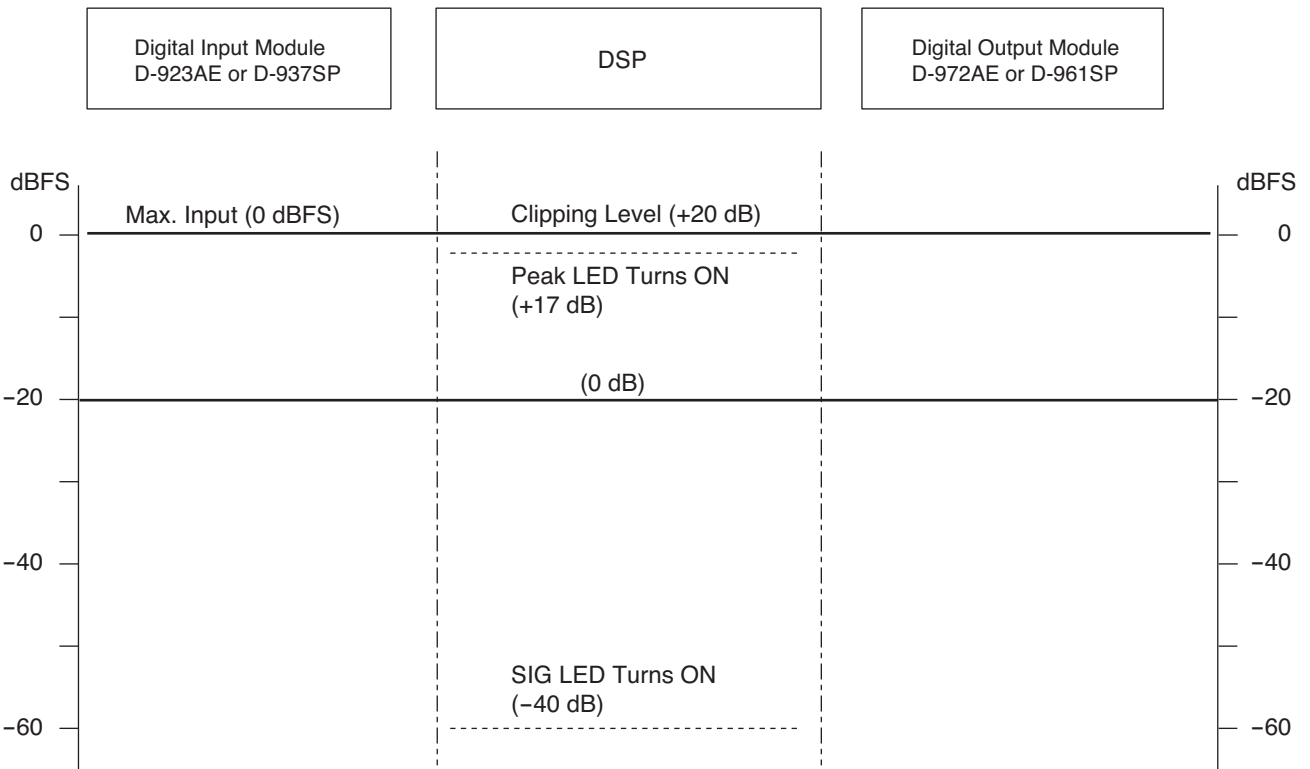

19. PARAMETER SETTING ITEMS AND SETTING RANGES

Note: Underlined parameters are factory-preset.

[Input and Output/Trim Settings]

Setting Item	Setting Range
Input Channel Gain	$-\infty$ to +10 dB
Input Trim Gain	-15 to +15 dB (<u>0 dB</u>), 0.1 dB steps
Input Trim Polarity	<u>NORMAL</u> , INVERSE
Input Channel Group Trim Gain	$-\infty$ to +10 dB, 0.1 dB steps
Output Channel Gain	$-\infty$ to +10 dB (<u>0 dB</u>)
Output Channel Group Trim Gain	$-\infty$ to +10 dB, 0.1 dB steps

[D-921F or D921E settings (enabled when the module is mounted)]

Setting Item	Setting Range
Phantom Power	ON, <u>OFF</u>
PAD (Input Sensitivity)	-50, -36, -10, <u>+4</u> dB

[D-936R settings (enabled when the module is mounted)]

Setting Item	Setting Range
Line Input Mode	<u>MIX ALL</u> , SELECT

[High-Pass Filter Settings]

Setting Item	Setting Range
Cutoff Frequency	20 Hz to 20 kHz (<u>60 Hz</u>), 1/24 octave steps
Slope	12 dB/oct
Q	0.500 – 2.563 (<u>0.707</u>) (51 points)
ON/OFF	ON, <u>OFF</u>

[Equalizer Settings]

Setting Item	Setting Range
Gain	-15 to +15 dB (<u>0 dB</u>), 0.1 dB steps
Center Frequency	20 Hz to 20 kHz (Low: <u>630 Hz</u> , High: <u>1.25 kHz</u>), 1/24 octave steps
Q	0.267 – 69.249 (<u>4.318</u>) (96 points)
ON/OFF	<u>ON</u> , OFF

[Compressor/Auto-Leveler Mode Settings]

Setting Item	Setting Range
Compressor/Auto-Leveler Mode	<u>COMP</u> , LEVELER

[Compressor Settings]

Setting Item	Setting Range
Threshold Level	-20 to +20 dB (<u>0 dB</u>), 1 dB steps
Ratio	<u>1:1</u> , 2:1, 3:1, 4:1, 8:1, 12:1, 20:1, ∞ :1
Attack Time	0.2, 0.5, 0.7, 1.0, 1.5, 2, 3, 5, 7, <u>10</u> , 20, 50, 70, 100, 120, 150, 200, 250, 300, 500, 700 ms 1, 2, 3, 5 s
Release Time	10, 20, 50, 70, 100, 120, 150, 200, 250, 300, <u>500</u> , 700 ms 1, 2, 3, 5 s
Gain	$-\infty$ to +10 dB (<u>0 dB</u>), 1 dB steps
ON/OFF	ON, <u>OFF</u>

[Auto-Leveler Settings]

Setting Item	Setting Range
Target Level	-20 to +10 dB (<u>0</u> dB), 1 dB steps
Maximum Gain	0 to +20 dB (<u>+6</u> dB), 1 dB steps
Attack Time	10, 20, 50, 70, 100, 120, 150, 200, 250, 300, <u>500</u> , 700 ms, 1, 1.2, 1.5, 2, 2.5, 3, 5, 7, 10 s
Release Time	100, 120, 150, 200, 250, 300, 500, 700 ms, 1, 1.2, 1.5, 2, 2.5, 3, 5, 7, 10 s

[Level Sense Settings]

Setting Item	Setting Range
Attack Time	<u>0.2</u> , 0.5, 0.7, 1.0, 1.5, 2, 3, 5, 7, 10, 20, 50, 70, 100, 120, 150, 200, 250, 300, 500, 700 ms 1, 2, 3, 5 s
Release Time	10, 20, 50, 70, 100, 120, 150, <u>200</u> , 250, 300, 500, 700 ms, 1, 2, 3, 5 s

[Gate Settings]

Setting Item	Setting Range
Threshold Level	-50 to +20 dB (<u>-40</u> dB), 1 dB steps
Hysteresis	<u>0</u> to +10 dB, 1 dB steps
Depth	-∞ to 0 dB (<u>-20</u> dB), 1 dB steps
Hold Time	<u>10</u> , 20, 50, 70, 100, 120, 150, 200, 250, 300, 500, 700 ms, 1, 2, 3, 5, 10 s
Attack Time	<u>10</u> , 20, 50, 70, 100, 120, 150, 200, 250, 300, 500, 700 ms, 1, 2, 3, 5, 10 s
Release Time	<u>10</u> , 20, 50, 70, 100, 120, 150, 200, 250, 300, 500, 700 ms, 1, 2, 3, 5, 10 s
ON/OFF	ON, <u>OFF</u>

[Auto-Mixing Group Settings]

Setting Item	Setting Range
Auto-Mixing Group	<u>GROUP A</u> , GROUP B, GROUP C, GROUP D

[Ducker Settings]

Setting Item	Setting Range
Priority Level	1 – <u>8</u> (in order of the priority level from high to low)
Depth	-∞ to 0 dB (<u>-20</u> dB), 1 dB steps
Attack Time	<u>10</u> , 20, 50, 70, 100, 120, 150, 200, 250, 300, 500, 700 ms, 1, 2, 3, 5, 10 s
Release Time	<u>10</u> , 20, 50, 70, 100, 120, 150, 200, 250, 300, 500, 700 ms, 1, 2, 3, 5, 10 s
ON/OFF	ON, <u>OFF</u>

[NOM Attenuation Settings]

Setting Item	Setting Range
Attenuation Gain	0 log ₁₀ NOM – 20 log ₁₀ NOM (<u>10</u>)
ON/OFF	ON, <u>OFF</u>

[Bus Assignment and Crosspoint Gain Settings]

Setting Item	Setting Range
Input 1	Output 1 – 8: ON, OFF Microphone Bus: ON, OFF
Input 2 – 12	Same as above
Microphone Bus	Output 1 – 8: ON, OFF
Gain	–∞ to 0 dB, 1 dB steps

[Crossover Settings]

Setting Item	Setting Range
Cutoff Frequency	20 Hz – 20 kHz (1 kHz), 1/24 octave steps
Slope BS: Bessel BW: Butterworth LR: Likwitz-Riley VQ: Variable Q	Through, 6 dB/oct, 12 dB/oct BS, 12 dB/oct BW, 12 dB/oct LR, 18 dB/oct BS, 18 dB/oct BW, 24 dB/oct BS, 24 dB/oct BW, 24 dB/oct LR
Q	0.500 – 2.563 (51 points)
Q2	0.500 – 2.563 (51 points)
GAIN	–15 to +15 dB (0 dB), 0.1 dB steps
Polarity	NORMAL, INVERSE

[Filter Settings]

Filter Type	Setting Item	Setting Range
Parametric Equalizer (PEQ)	Gain	–15 to +15 dB (0 dB), 0.1 dB steps
	Center frequency	20 Hz – 20 kHz (1 kHz), 1/24 octave steps
	Q	0.267 – 69.249 (96 points)
High-pass Filter (HPF)	Cutoff frequency	20 Hz – 20 kHz (1 kHz), 1/24 octave steps
	Slope	6 dB/oct 12 dB/oct
	Q	0.500 – 2.563 (51 points)
Low-pass Filter (LPF)	Cutoff frequency	20 Hz – 20 kHz (1 kHz), 1/24 octave steps
	Slope	6 dB/oct 12 dB/oct
	Q	0.500 – 2.563 (51 points)
High Shelving Filter	Gain	–15 to +15 dB (0 dB), 0.1 dB steps
	Roll-off frequency	6 – 20 kHz, 1/24 octave steps
Low Shelving Filter	Gain	–15 to +15 dB (0 dB), 0.1 dB step
	Roll-off frequency	20 – 500 Hz, 1/24 octave steps
Horn Equalizer (Horn EQ)	Gain	0 to +18 dB, 0.5 dB step
Notch Filter	Center frequency	20 Hz – 20 kHz (1 kHz), 1/24 octave steps
	Q	8.651, 9.889, 11.538, 13.847, 17.310, 23.081, 34.623, 69.249
All-pass Filter	Center frequency	20 Hz – 20 kHz (1 kHz), 1/24 octave steps
	Q	0.267 – 69.249 (96 points)
_____	ON/OFF	ON, OFF

[Delay Time Settings]

Setting Item	Setting Range
Delay Time	0 – 682.6 ms, 0.021 ms steps
ON/OFF	ON, OFF

[Feedback Suppression Settings]

Parameter	Setting Item	Setting Range
DYNAMIC	Dynamic mode ON/OFF	ON, <u>OFF</u>
AUTO START	Auto mode activation	—
AUTO : DYNAMIC	Number of the filters used in each mode	AUTO : 0 – 9 (<u>Z</u>), DYNAMIC : 3 – 12 (<u>5</u>)
CLEAR DYNAMIC	Reset the filters set for Dynamic mode	—
CLEAR AUTO	Reset the filters set for Auto mode	—

[Feedback Suppression Filter Setting]

Setting Item	Setting Range
Gain	–15 to +15 dB, 0.1 dB steps
Center Frequency	20 Hz – 20 kHz, 1/24 octave steps
Q	0.267 – 69.249 (96 points)

Note

Performing the feedback suppression function automatically sets the above parameters. They can be confirmed on the setting screen, but not manually changed.

[Effect (echo) Settings]

Setting Item	Setting Range
Echo Gain	–∞ to 10.0 dB (<u>–10 dB</u>), 1 dB steps
Feedback Ratio	0 – 99% (<u>30%</u>), 1% steps
Feedback Delay	0 – 682 ms (<u>120 ms</u>), 1 ms steps
Initial Echo (Pre-) Delay	0 – 682 ms (<u>80 ms</u>), 1 ms steps
Low-pass Filter Frequency	20 Hz – 20 kHz (<u>3.75 kHz</u>)
Q	<u>0.500</u> – 2.563 (51 points)
ON/OFF	ON, <u>OFF</u>

[Preset Memory Crossfade Time Settings]

Setting Item	Setting Range
Crossfade Time	<u>0</u> – 10 s, 0.5 s steps

[Initial Preset Memory Settings]

Setting Item	Setting Range
Preset Memory	<u>LAST MEMORY</u> , 1 – 16

[Contact Input/Output Settings]

Setting Item	Setting Range
Contact Input	<u>Memory</u> (factory-preset: 1 – 8), Volume Up/Down, Channel On/Off Stereo input, <u>None</u> (factory-preset: 9 – 24)
Contact Output	<u>Normally break</u> (factory-preset: 9 – 24), Normally make, <u>Memory</u> (factory-preset: 1 – 8), Channel On/Off, Contact input status, Stereo input

[RS-232C Port Settings]

Setting Item	Setting Range
Control Mode	UPDATE, REMOTE, <u>PC CTRL</u>
RS-232C transmission rate	<u>115200</u> , 38400, 19200, 9600 bps

20. SPECIFICATIONS

20.1. D-901 Digital Mixer

Model Number	D-901 US/314L	D-901 CE/315H	D-901 CE-GB	D-901 KR
Power Source	100 – 120 V AC, 50/60 Hz	230 V AC, 50/60 Hz	220 – 230 V AC, 50/60 Hz	220 V AC, 60 Hz
Power Consumption	40 W	27 W		26.94 W
Frequency Response	20 – 20,000 Hz, ± 1 dB (± 4 dB* input)			
Input	Max. 12 channels, modular construction (modules optional)			
Output	Max. 8 channels, modular construction (modules optional)			
Signal Processing	Feedback Suppression Function	12 filters (auto/dynamic)		
	Auto Mixing Function	Ducker (auto muting), NOM attenuation		
	Auto Mixing Group	4 groups		
	Equalizer/Filter	Parametric equalizer: 20 – 20,000 Hz, ± 15 dB, Q: 0.267 – 69.249 Filtering: High-pass filter 20 – 20,000 Hz, 6 dB/oct, 12 dB/oct Low pass filter 20 – 20,000 Hz, 6 dB/oct, 12 dB/oct Notch filter 20 – 20,000 Hz, Q: 8.651 – 69.249 All-pass filter 20 – 20,000 Hz, Q: 0.267 – 69.249 High shelving filter 6 – 20,000 Hz, ± 15 dB Low shelving filter 20 – 500 Hz, ± 15 dB Horn equalizer 20 kHz, 0 to +18 dB (1 dB steps) Crossover filter: 20 – 20,000 Hz, 6 dB/oct, 12 dB/oct, 18 dB/oct, 24 dB/oct		
	Compressor /Auto-Leveler	(Compressor mode) Threshold: –20 to +20 dB (1 dB steps) Ratio: 1:1, 2:1, 3:1, 4:1, 8:1, 12:1, 20:1, ∞ :1 Attack time: 0.2 ms – 5 s Release time: 10 ms – 5 s Gain: $-\infty$ to +10 dB (Auto-leveler mode) Target level: –20 to +20 dB (1 dB steps) Maximum gain: 0 to +20 dB (1 dB steps) Attack time: 10 ms – 10 s Release time: 100 ms – 10 s		
	Delay	Delay time: 0 – 682.6 ms (0.021 ms steps)		
	Matrix	12 x 8		
	Crosspoint Gain	$-\infty$ to 0 dB (1 dB steps)		
	Preset Memory	16		
	Auxiliary Function	Protect function		
Control	RS-232C, D-sub connector (9 pins), Remote control module (option)			
Front Panel Section	Preset memory selector key: 8 LCD screen, screen shift key (up/down/left/right), setting knob Input level indicator: Dual color LED Output level indicator: Dual color LED Channel selector key: 12 (input channel selection) 8 (output channel selection) Channel volume control: 1 (input channel selection) 1 (output channel selection)			
Rear Panel	Input module slot: 6 (input/output module slot: 2) Output module slot: 2 Remote control module slot: 1			
Operating Temperature	+5 to +40 °C			
Finish	Panel: Aluminum, hair-line finish, black Others: Pre-coated steel plate, black (30% glossy)			
Dimensions	482.6 (w) x 132.6 (h) x 320 (d) mm (excluding projection)			
Weight	6.9 kg			

* 0 dB = 0.775 V

Note: The design and specifications are subject to change without notice for improvement.

• Accessories

AC power cord (2 m)	1	Rack mounting bracket (preinstalled on the unit) ..	2
Rack mounting screw (5 x 12)	4	Module mounting screw (spare)	4
Fiber washer for M5	4	Blank panel (preinstalled on the module slot)	9

20.2. D-921F Microphone/Line Input Module (Optional)

Input	2 channels, Mic/Line changeable Mic: $-50/-36$ dB*, 4.7 k Ω , electronically-balanced, equivalent to XLR-3-31 type Line: $-10/+4$ dB*, 10 k Ω , electronically-balanced, equivalent to XLR-3-31 type Phantom power supply (+15 V, can be used when set for the microphone) Ground lift switch
A/D Converter	24 bits
Sampling Frequency	48 kHz
Frequency Response	20 – 20,000 Hz, ± 1 dB (+4 dB* input)
Dynamic Range	Over 100dB (IHF-A weighted) (+4 dB* input)
Total Harmonic Distortion	Under 0.05% (+4 dB* input)
Finish	Panel: Pre-coated steel plate, black (30% glossy)
Dimensions	35 (w) x 119.5 (h) x 178.4 (d) mm
Weight	150 g

20.3. D-921E Microphone/Line Input Module (Optional)

Input	2 channels, Mic/Line changeable Mic: $-50/-36$ dB*, 4.7 k Ω , electronically-balanced, 3-pin removable terminal block Line: $-10/+4$ dB*, 10 k Ω , electronically-balanced, 3-pin removable terminal block Phantom power supply (+15 V, can be used when set for the microphone) Ground lift switch
A/D Converter	24 bits
Sampling Frequency	48 kHz
Frequency Response	20 – 20,000 Hz, ± 1 dB (+4 dB* input)
Dynamic Range	Over 100dB (IHF-A weighted) (+4 dB* input)
Total Harmonic Distortion	Under 0.05% (+4 dB* input)
Finish	Panel: Pre-coated steel plate, black (30% glossy)
Dimensions	35 (w) x 119.5 (h) x 178.4 (d) mm
Weight	140 g

• Accessories

3-pin removable terminal plug (preinstalled on the unit) 2

20.4. D-922F Microphone/Line Input Module (Optional)

Input	2 channels, $-50/-36/-10/+4$ dB* (Selectable with the DIP switch), 4.7 k Ω , electronically-balanced, equivalent to XLR-3-31 type Phantom power supply (+15 V, can be set with the DIP switch) Ground lift switch (can be set with the DIP switch)
A/D Converter	20 bits
Sampling Frequency	48 kHz
Frequency Response	20 – 20,000 Hz, ± 1 dB (+4 dB* input)
Dynamic Range	Over 85 dB (IHF-A weighted) (+4 dB* input)
Total Harmonic Distortion	Under 0.2% (+4 dB* input)
Finish	Panel: Pre-coated steel plate, black (30% glossy)
Dimensions	35 (w) x 119.5 (h) x 178.4 (d) mm
Weight	135 g

* 0 dB = 0.775 V

Note: The design and specifications are subject to change without notice for improvement.

20.5. D-922E Microphone/Line Input Module (Optional)

Input	2 channels, -50/-36/-10/+4 dB* (Selectable with the DIP switch), 4.7 k Ω , electronically-balanced, 3-pin removable terminal block Phantom power supply (+15 V, can be set with the DIP switch) Ground lift switch (can be set with the DIP switch)
A/D Converter	20 bits
Sampling Frequency	48 kHz
Frequency Response	20 – 20,000 Hz, ± 1 dB (+4 dB* input)
Dynamic Range	Over 85 dB (IHF-A weighted) (+4 dB* input)
Total Harmonic Distortion	Under 0.2% (+4 dB* input)
Finish	Panel: Pre-coated steel plate, black (30% glossy)
Dimensions	35 (w) x 119.5 (h) x 178.4 (d) mm
Weight	125 g

• Accessories

3-pin removable terminal plug (preinstalled on the unit) 2

20.6. D-936R Stereo Input Module (Optional)

Input	4 stereo inputs (Selection of 1 stereo or mixing or all 4 stereo inputs) -10 dB*, 10 k Ω , RCA pin jack
A/D Converter	24 bits
Sampling Frequency	48 kHz
Frequency Response	20 – 20,000 Hz, ± 1 dB (+4 dB* input)
Dynamic Range	Over 100dB (IHF-A weighted)
Total Harmonic Distortion	Under 0.05%
Finish	Panel: Pre-coated steel plate, black (30% glossy)
Dimensions	35 (w) x 119.5 (h) x 178.4 (d) mm
Weight	145 g

20.7. D-923AE Digital Input Module (Optional)

Input	2 channels, 2.0 – 7.0 V (p-p), 110 Ω , equivalent to XLR-3-31
Applicable Format	AES/EBU (2 channel multiplexed)
Sampling Frequency	32 – 48 kHz
Finish	Panel: Pre-coated steel plate, black (30% glossy)
Dimensions	35 (w) x 119.5 (h) x 178.4 (d) mm
Weight	130 g

20.8. D-937SP Digital Input Module (Optional)

Input	Stereo 1 channel (Selectable one of 4 inputs) 0.5 V (p-p), 75 Ω , Coaxial RCA pin jack x 2 Square optical connector x 2
Applicable Format	S/PDIF (2 channel multiplexed)
Sampling Frequency	32 – 48 kHz
Finish	Panel: Pre-coated steel plate, black (30% glossy)
Dimensions	35 (w) x 119.5 (h) x 178.4 (d) mm
Weight	130 g

* 0 dB = 0.775 V

Note: The design and specifications are subject to change without notice for improvement.

20.9. D-971M Line Output Module (Optional)

Output	4 channels, +4 dB*, adaptable load of over 600 Ω, electronically-balanced, equivalent to XLR-3-32 type
D/A Converter	24 bits
Sampling Frequency	48 kHz
Frequency Response	20 – 20,000 Hz, ±1 dB
Dynamic Range	Over 100dB (IHF-A weighted)
Total Harmonic Distortion	Under 0.05%
Finish	Panel: Pre-coated steel plate, black (30% glossy)
Dimensions	35 (w) x 119.5 (h) x 178.4 (d) mm
Weight	165 g

20.10. D-971E Line Output Module (Optional)

Output	4 channels, +4 dB*, adaptable load of over 600 Ω, electronically-balanced, 3-pin removable terminal block
D/A Converter	24 bits
Sampling Frequency	48 kHz
Frequency Response	20 – 20,000 Hz, ±1 dB
Dynamic Range	Over 100dB (IHF-A weighted)
Total Harmonic Distortion	Under 0.05%
Finish	Panel: Pre-coated steel plate, black (30% glossy)
Dimensions	35 (w) x 119.5 (h) x 178.4 (d) mm
Weight	140 g

• Accessories

3-pin removable terminal plug (preinstalled on the unit) 2

20.11. D-971R Line Output Module (Optional)

Output	4 channels (2 outputs for each channel), –10 dB*, adaptable load of over 600 Ω, RCA pin jack
D/A Converter	24 bits
Sampling Frequency	48 kHz
Frequency Response	20 – 20,000 Hz, ±1 dB
Dynamic Range	Over 100dB (IHF-A weighted)
Total Harmonic Distortion	Under 0.05%
Finish	Panel: Pre-coated steel plate, black (30% glossy)
Dimensions	35 (w) x 119.5 (h) x 178.4 (d) mm
Weight	150 g

20.12. D-972AE Digital Output Module (Optional)

Output	4 channels, 5.0 V (p-p), 110 Ω, equivalent to XLR-3-32
Applicable Format	AES/EBU (2 channel multiplexed)
Sampling Frequency	48 kHz
Finish	Panel: Pre-coated steel plate, black (30% glossy)
Dimensions	35 (w) x 119.5 (h) x 178.4 (d) mm
Weight	130 g

• Accessories

Ferrite clamp 2

* 0 dB = 0.775 V

Note: The design and specifications are subject to change without notice for improvement.

20.13. D-961SP Digital Output Module (Optional)

Output	Stereo 2 channels (with splitter, each pair of optical output and coaxial output in parallel), 0.5 V (p-p), 75 Ω, Coaxial RCA jack x 2 Square optical connector x 2
Applicable Format	S/PDIF (2 channel multiplexed)
Sampling Frequency	48 kHz
Finish	Panel: Pre-coated steel plate, black (30% glossy)
Dimensions	35 (w) x 119.5 (h) x 178.4 (d) mm
Weight	130 g

20.14. D-981 Remote Control Module (Optional)

Contact Input	COM + Terminals 1 – 8: Open voltage: 5 V DC, short-circuit: 5 mA, 10-pin removable terminal block
Control	Preset Memory Selection Any preset memory can be recalled. Control method: No-voltage make of over 100 ms or no-voltage make single pulse of over 100 ms
	Volume Volume can be turned UP or DOWN for any input and output channels. Control system: 1 step variation for no-voltage make single pulse of over 100 ms 1 step continuous operation for every 70 ms for no-voltage make of over 100 ms. Can be reset when at break. Variable range: $-\infty$ dB to +10 dB
	Channel Any input/output channels can be turned ON and OFF. Control method: No-voltage make of over 100 ms or no-voltage make single pulse of over 100 ms
	Stereo Selection Any stereo input can be selected. Control method: No-voltage make of over 100 ms or no-voltage make single pulse of over 100 ms
Contact Output	COM + Terminals 1 – 8: No-voltage make contact input, contact capacity: 24 V DC, 100 mA removable terminal block
Finish	Panel: Pre-coated steel plate, black (30% glossy)
Dimensions	35 (w) x 119.5 (h) x 178.4 (d) mm
Weight	125 g

Note: The design and specifications are subject to change without notice for improvement.

• Accessories

10-pin removable terminal plug (preinstalled on the unit) 2

20.15. D-983 Remote Control Module (Optional)

Contact Input	COM + Terminals 1 – 24: Open voltage 5 V DC, short-circuit current 5 mA, RJ45 connector x 4
Control	Preset Memory Selection Any preset memory can be recalled. Control method: No-voltage make of over 100 ms or no-voltage make single pulse of over 100 ms
	Volume Control Any input/output channel volume can be turned UP or DOWN. Control method: 1 step variation with no-voltage make single pulse of over 100 ms 1 step continuous operation for every 70 ms for no-voltage make of over 100 ms. Can be reset when at break. Variable range: $-\infty$ dB to +10 dB
	Channel Any input/output channel can be turned ON and OFF. Control method: No-voltage make of over 100 ms or no-voltage make single pulse of over 100 ms
	Stereo Selection Input stereo channel of the D-936R (optional) or the D-937SP (optional) can be selected. Control method: No-voltage make of over 100 ms or no-voltage make single pulse of over 100 ms
Contact Output	COM + Terminals 1 – 16: No-voltage make contact, contact capacity: 24 V DC, 100 mA, RJ45 connector x 4
Finish	Panel: Pre-coated steel plate, black (30% glossy)
Dimensions	35 (w) x 119.5 (h) x 178.4 (d) mm
Weight	170 g

20.13. D-984VC VCA Control Module (Optional)

VCA Control Input	+5 V, GND, Terminals 1 – 20 (12 Input channels, 8 output channels), RJ45 connector x 4 Control contacts: Volume control of each input/output channel Variable range: $-\infty$ dB to +0 dB
Contact Input	COM + Terminals 1 – 8: Open voltage 5 V DC, short-circuit current 5 mA, RJ45 connector x 2
Control	Preset Memory Selection Any preset memory can be recalled. Control method: No-voltage make of over 100 ms or no-voltage make single pulse of over 100 ms
	Volume Control Any input/output channel volume can be turned UP or DOWN. Control method: 1 step variation with no-voltage make single pulse of over 100 ms 1 step continuous operation for every 70 ms for no-voltage make of over 100 ms. Can be reset when at break. Variable range: $-\infty$ dB to +10 dB
	Channel Any input/output channel can be turned ON and OFF. Control method: No-voltage make of over 100 ms or no-voltage make single pulse of over 100 ms
	Stereo Selection Input stereo channel of the D-936R (optional) or the D-937SP (optional) can be selected. Control method: No-voltage make of over 100 ms or no-voltage make single pulse of over 100 ms
Contact Output	COM + Terminals 1 – 8: No-voltage make contact, contact capacity: 24 V DC, 100 mA, RJ45 connector x 2
Finish	Panel: Pre-coated steel plate, black (30% glossy)
Dimensions	35 (w) x 119.5 (h) x 178.4 (d) mm
Weight	170 g

Note: The design and specifications are subject to change without notice for improvement.

URL: <https://www.toa.jp/>