

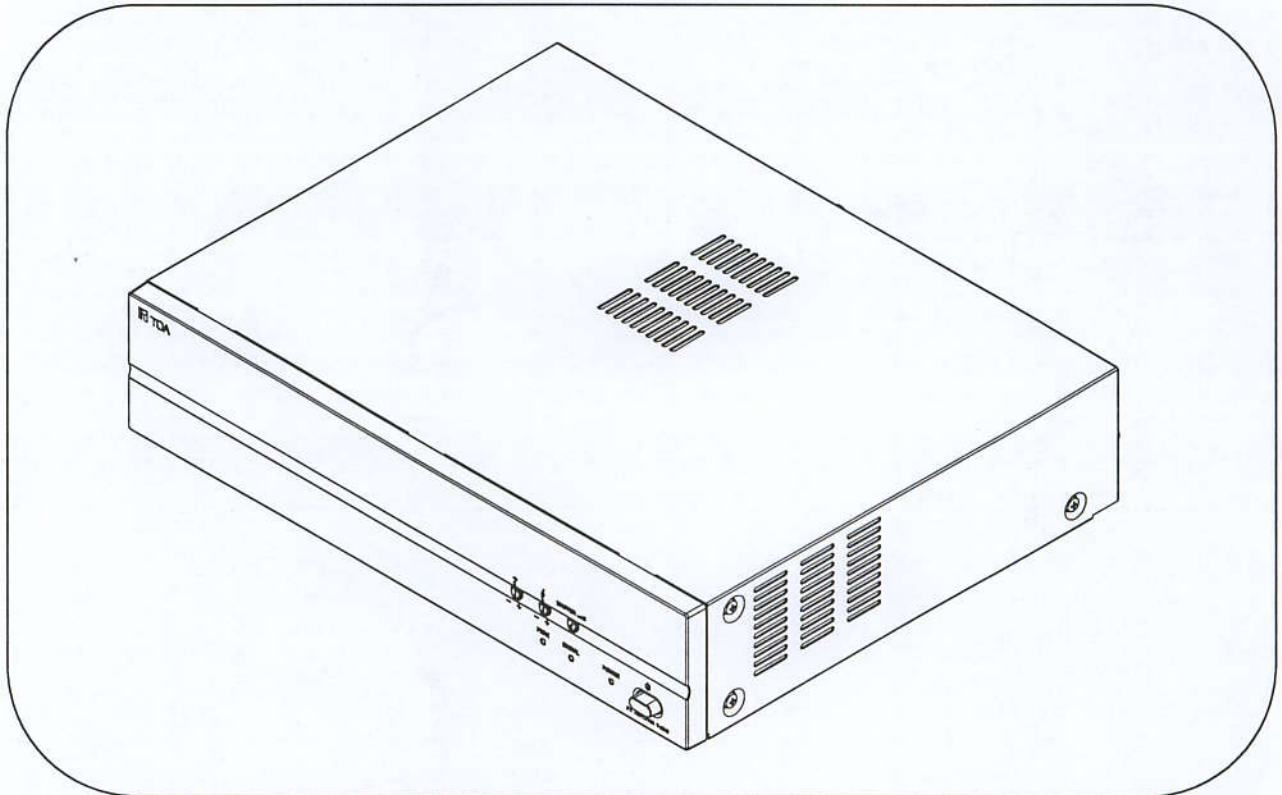

PA AMPLIFIERS

OPERATING INSTRUCTIONS

P-2240 CE  
P-2240 CE-GB  
P-2240 CE-AU



Please follow the instructions in this manual to obtain the optimum results from this unit.  
We also recommend that you keep this manual handy for future reference.

TOA Corporation

## TABLE OF CONTENTS

|     |                                                      |    |
|-----|------------------------------------------------------|----|
| 1.  | IMPORTANT SAFETY INSTRUCTIONS.....                   | 3  |
| 2.  | SAFETY PRECAUTIONS .....                             | 3  |
| 3.  | GENERAL DESCRIPTION .....                            | 5  |
| 4.  | FEATURES.....                                        | 5  |
| 5.  | NOMENCLATURE AND FUNCTIONS                           |    |
|     | 5.1 Front .....                                      | 5  |
|     | 5.2 Rear .....                                       | 5  |
| 6.  | CONNECTIONS                                          |    |
|     | 6.1. Input Connections .....                         | 6  |
|     | 6.2. Output Connections .....                        | 8  |
|     | 6.3. Example of External Equipment Connections ..... | 8  |
| 7.  | INSTALLATION .....                                   | 9  |
| 8.  | VOLUME CONTROL SETTINGS .....                        | 9  |
| 9.  | BLOCK LEVEL DIAGRAM .....                            | 9  |
| 10. | DIMENSIONAL DIAGRAM .....                            | 10 |
| 11. | SPECIFICATIONS .....                                 | 11 |

# 1. IMPORTANT SAFETY INSTRUCTIONS

- Read these instructions.
- Keep these instructions.
- Heed all warnings.
- Follow all instructions.
- Do not use this apparatus near water.
- Clean only with dry cloth.
- Do not block any ventilation openings. Install in accordance with the manufacture's instructions.
- Do not install near any heat sources such as radiators, heat registers, stoves, or other apparatus (including amplifiers) that produce heat.
- Do not defeat the safety purpose of the polarized or grounding-type plug. A polarized plug has two blades with one wider than the other. A grounding type plug has two blades and a third grounding prong. The wide blade or the third prongs are provided for your safety. If the provided plug does not fit into your outlet, consult an electrician for replacement of the obsolete outlet.
- Protect the power cord from being walked on or pinched particularly at plugs, convenience receptacles, and the point where they exit from the apparatus.
- Only use attachments/accessories specified by the manufacturer.
- Use only with the cart, stand, tripod, bracket, or table specified by the manufacturer, or sold with the apparatus.
- When a earth is used, use caution when moving the cart/apparatus combination to avoid injury from tip-over.
- Unplug this apparatus during lightning storms or when unused for long periods of time.
- Refer all servicing to qualified service personnel. Servicing is required when the apparatus has been damaged in any way, such as power-supply cord or plug is damaged, Liquid has been spilled or objects have fallen into the apparatus, the apparatus has been exposed to rain or moisture, does not operate normally, or has been dropped.



# 2. SAFETY PRECAUTIONS

- Before installation or use, be sure to carefully read all the instructions in this section for correct and safe operation.
- Be sure to follow all the precautionary instructions in this section, which contain important warnings and/or cautions regarding safety.
- After reading, keep this manual handy for future reference.

## Safety Symbol and Message Conventions

Safety symbols and messages described below are used in this manual to prevent bodily injury and property damage which could result from mishandling.

Before operating your product, read this manual first and understand the safety symbols and messages so you are thoroughly aware of the potential safety hazards.



The exclamation point within an equilateral triangle is intended to alert the user to the presence of important operation and maintenance (servicing) instruction in the literature accompanying the appliance.



## WARNING

Indicates a potentially hazardous situation which, if mishandled, could result in death or serious personal injury.

## When Installing the Unit

- Do not expose the unit to rain or an environment where it may be splashed by water or other liquids, as doing so may result in fire or electric shock.
- Use the unit only with the voltage specified on the unit. Using a voltage higher than that which is specified may result in fire or electric shock.
- Do not cut, kink, otherwise damage nor modify the power supply cord. In addition, avoid using the power cord in close proximity to heaters, and never place heavy objects -- including the unit itself -- on the power cord, as doing so may result in fire or electric shock.
- Avoid installing or mounting the unit in unstable locations, such as on a rickety table or a slanted surface. Doing so may result in the unit falling down and causing personal injury and/or property damage.
- The terminals marked with the symbol  are hazardous live. The external wiring to these terminals requires installation by an instructed person.
- The apparatus shall be connected to a mains socket outlet with a protective earthing connection.
- The socket-outlet shall be installed near the equipment and the plug shall be easily accessible.

## When the Unit is in Use

- Should the following irregularity be found during use, immediately switch off the power, disconnect the power supply plug from the AC outlet and contact your nearest TOA dealer. Make no further attempt to operate the unit in this condition as this may cause fire or electric shock.
  - If you detect smoke or a strange smell coming from the unit.
  - If water or any metallic object gets into the unit.
  - If the unit falls, or the unit case breaks.
  - If the power supply cord is damaged (exposure of the core, disconnection, etc.)
  - If it is malfunctioning (no tone sounds.)
- To prevent a fire or electric shock, never open nor remove the unit case as there are high voltage components inside the unit. Refer all servicing to you nearest TOA dealer.
- Do not place cups, bowls, or other containers of liquid or metallic objects on top of the unit. If they accidentally spill into the unit, this may cause a fire or electric shock.



### CAUTION

Indicates a potentially hazardous situation which, if mishandled, could result in moderate or minor personal injury, and/or property damage.

## When Installing the Unit

- Never plug in nor remove the power supply plug with wet hands, as doing so may cause electric shock.
- When unplugging the power supply cord, be sure to grasp the power supply plug; never pull on the cord itself. Operating the unit with a damaged power supply cord may cause a fire or electric shock.
- Do not block the ventilation slots in the unit's cover. Doing so may cause heat to build up inside the unit and result in fire.
- Avoid installing the unit in humid or dusty locations, in locations exposed to the direct sunlight, near the heaters, or in locations generating sooty smoke or steam as doing otherwise may result in fire or electric shock.
- To avoid electric shocks, be sure to unplug the unit's power supply cord when connecting speakers.
- Be sure to follow the instructions below when rack-mounting the unit. Failure to do so may cause a fire or personal injury.

- Install the equipment rack on a stable, hard floor. Fix it with anchor bolts or take other arrangements to prevent it from falling down.
- When connecting the unit's power cord to an AC outlet, use the AC outlet with current capacity allowable to the unit.
- No rack-mounting screws are supplied with the unit. Separately prepare the appropriate screws for the rack.
- Keep the 2000 series amplifiers over 10 cm away from objects that may obstruct air flow to prevent the unit's internal temperature rise.

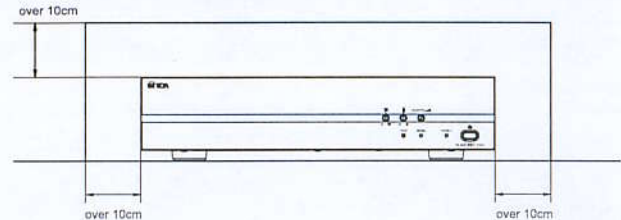

## When the Unit is in Use

- Do not operate the unit for an extended period of time with the sound distorting. This is an indication of a malfunction, which in turn can cause heat to generate and result in a fire.
- Switch off the power, and unplug the power supply plug from the AC outlet for safety purposes when cleaning or leaving the unit unused for 10 days or more. Doing otherwise may cause a fire or electric shock.

An all-pole mains switch with a contact separation of at least 3 mm in each pole shall be incorporated in the electrical installation of the building.



The lighting flash with arrowhead symbol, within an equilateral triangle, is intended to alert the user to the presence of uninsulated "dangerous voltage" within the product's enclosure that may be of sufficient magnitude to constitute a risk of electric shock to persons.



### ATTENTION

- L'appareil ne doit pas être exposé aux éclaboussures ou écoulements et tous objets remplis de liquide, tels que vases, ne doivent pas être sur l'appareil.

## Traceability Information for Europe (EMC directive 2004/108/EC)

Manufacturer:  
TOA Corporation  
7-2-1, Minatojima Nakamachi, Chuo-ku, Kobe, Hyogo,  
Japan

Authorized representative:  
TOA Electronics Europe GmbH  
Suederstrasse 282, 20537 Hamburg,  
Germany

URL: <http://www.toa.jp/>

### 3. GENERAL DESCRIPTION

TOA's Basic Power Amplifiers P-2240 is high cost-performance power amplifiers suited for broadcasting paging or background music in schools, offices, shops, factories, mosques, churches and large rooms.

### 4. FEATURES

- High durability, high reliability, and high cost performance.
- Two balanced parallel inputs, one speaker line input.
- Speaker output of constant voltage distribution system (70V or 100V) and low impedance (4Ω).
- Operates on both AC and DC power.
- Semi fixed master volume control and independent speaker line input volume control.
- Semi fixed and independent tone controls of boost and cut type for both high and low frequencies.
- Power remote switch by make contact input.

### 5. NOMENCLATURES AND FUNCTIONS

#### 5.1. Front

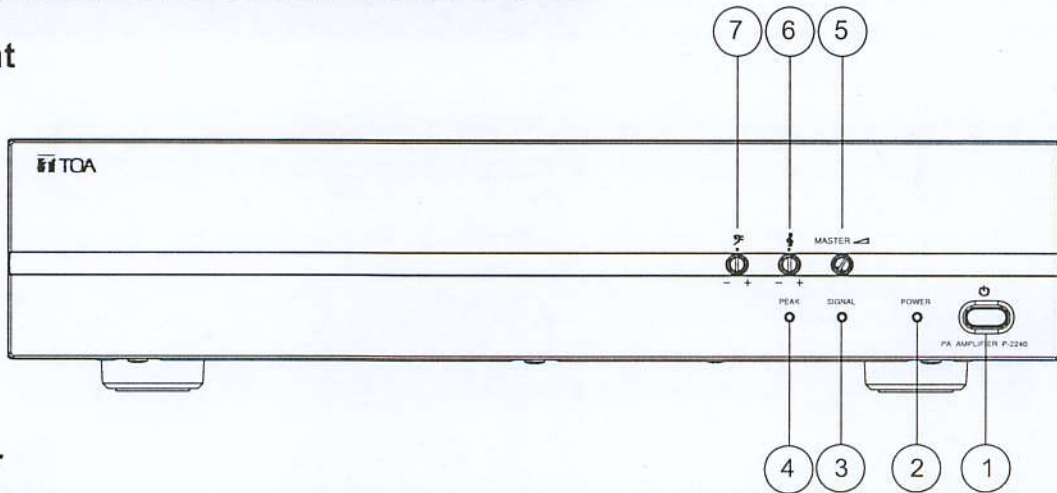

#### 5.2. Rear

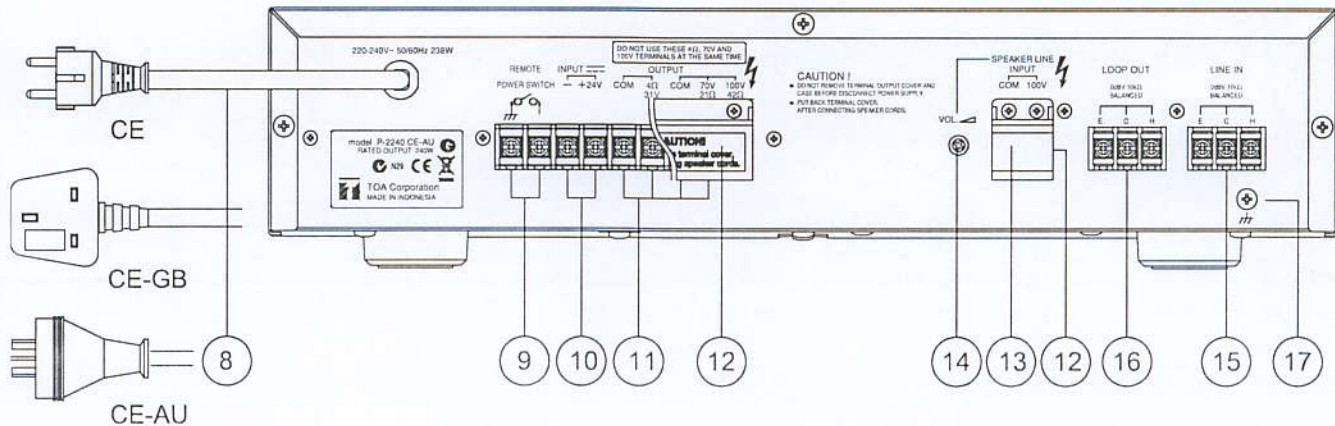

1. **Power Switch**  
Press to turn ON the power.  
Press again to turn the power OFF.  
Disconnect the AC mains plug or DC Terminal to shut the power OFF completely.
2. **Power Indicator**  
Lights green when power is switched ON.
3. **Signal Indicator**  
Lights green when power is switched ON, and indicates an output signal.
4. **Peak Indicator**  
Lights red to indicate the output signal reaches the peak level, this indicates that sound is distorted. In such a case, adjust the master volume control to reduce output level.
5. **Master Volume Control**  
Adjusts the overall signal level.
6. **Treble Control**  
Adjusts treble response. Rotate clockwise to increase treble output, and counterclockwise to reduce it. The center position provides flat characteristics.
7. **Bass Control**  
Adjusts bass response. Rotate clockwise to increase bass output, and counterclockwise to reduce it. The center position provides flat characteristics.
8. **AC Power Cord**  
Connects to an AC power source.
9. **Power Remote Switch**  
Connects to external switch. With the unit's power switched OFF, shorting the Power Remote terminals can remotely turn it. With ON, the power cannot be remotely controlled.
10. **DC Terminal**  
Connects to a DC power supply of 24V.
11. **Output Terminals**  
Connect to speakers. When connecting speakers, use only one of the speaker output terminals, low or high impedance.
12. **Terminal Cover**  
To avoid electric shocks by high voltage from output/input terminal, put back the terminal cover after connecting cords.
13. **Speaker Line Input**  
40dB, 10k $\Omega$ , unbalanced. Connects to 100V line speaker output.
14. **Speaker Line In Volume Control**  
Adjusts the signal level.
15. **Line Input**  
0dB, 10k $\Omega$ , transformer balanced. Connects to Line Out/Rec Out of Mixer Amplifier or Loop Out of other P-2240 Power Amplifier.
16. **Loop Output**  
0dB, 10k $\Omega$ , transformer balanced. Parallel connection with Line Input. Connects to Line In of other P-2240 Power Amplifier.
17. **Ground Terminal**  
Connect to ground (earth) avoid electric shock.

## 6. CONNECTIONS

### 6.1. Input Connections

- **Connection with the mixer preamplifier having the balanced type output.**  
Because it is hard to be affected by the external noise, the connections of the balanced type please adopt this connection manner as much as possible.  
And also it recommends this connection when distance of the mixer preamplifier is separated from this power amplifier more than 10m or, in the location where there is a lot of electric noise.

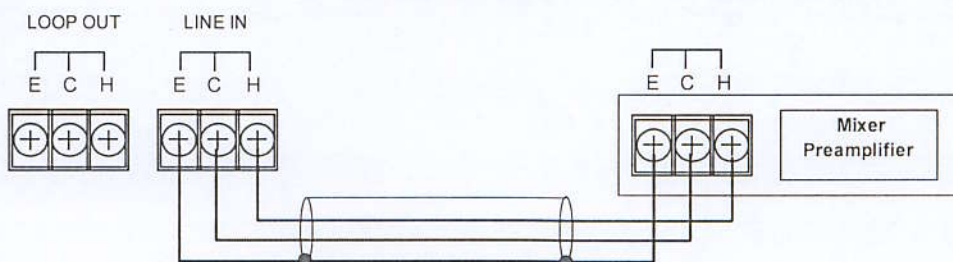

- Connection with the mixer preamplifier having the unbalanced type output. Please make the length of the cable less than several meters.

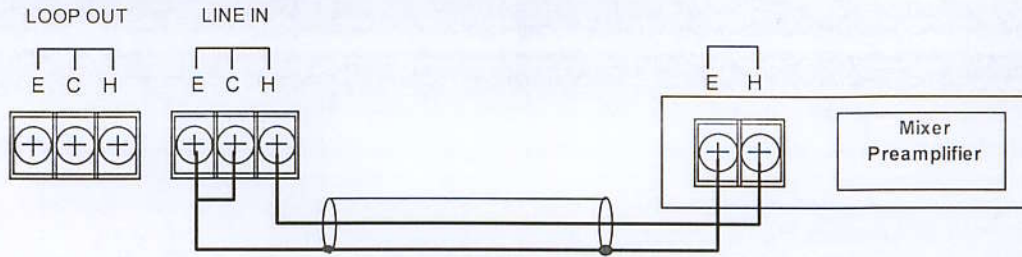

- Speaker Line Input Connection  
It is connected to the High Impedance (70V /100V) speaker wiring of other amplifier.

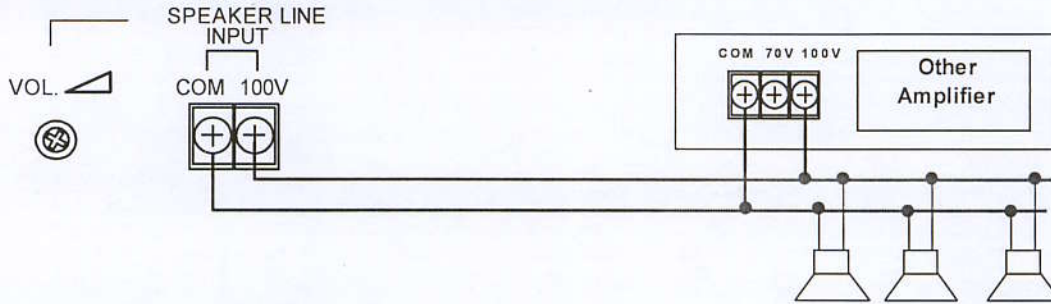

- Parallel connection of the input.

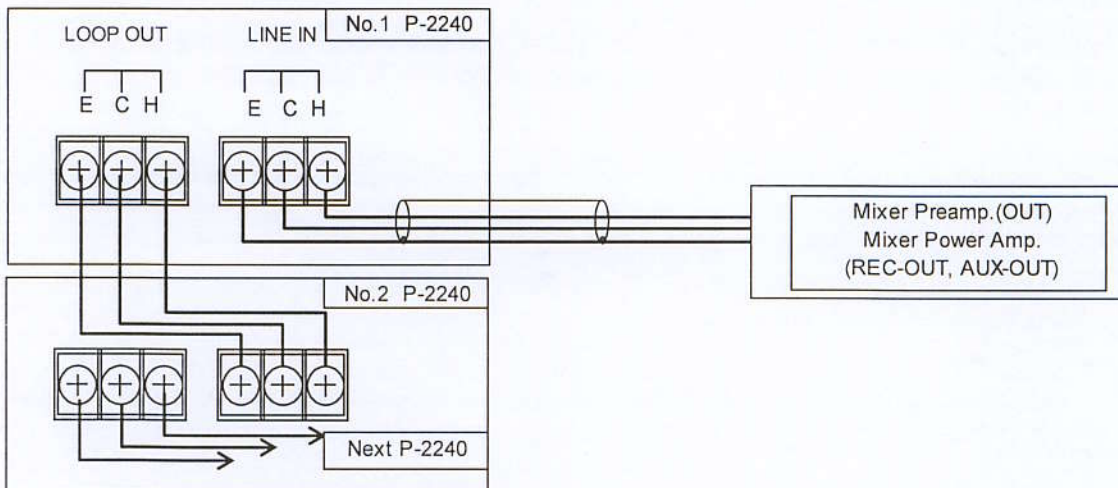

- Remote Power Switch Connection

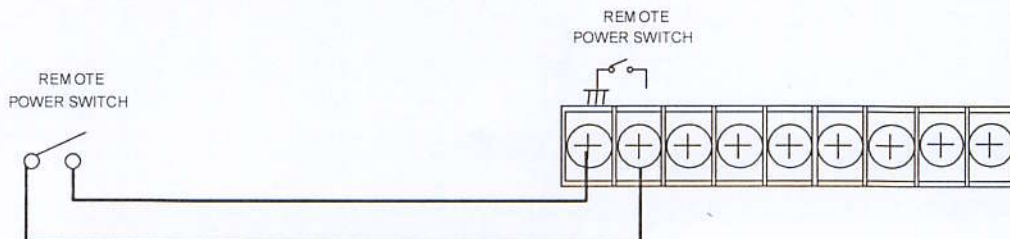

## 6.2. Output Connections

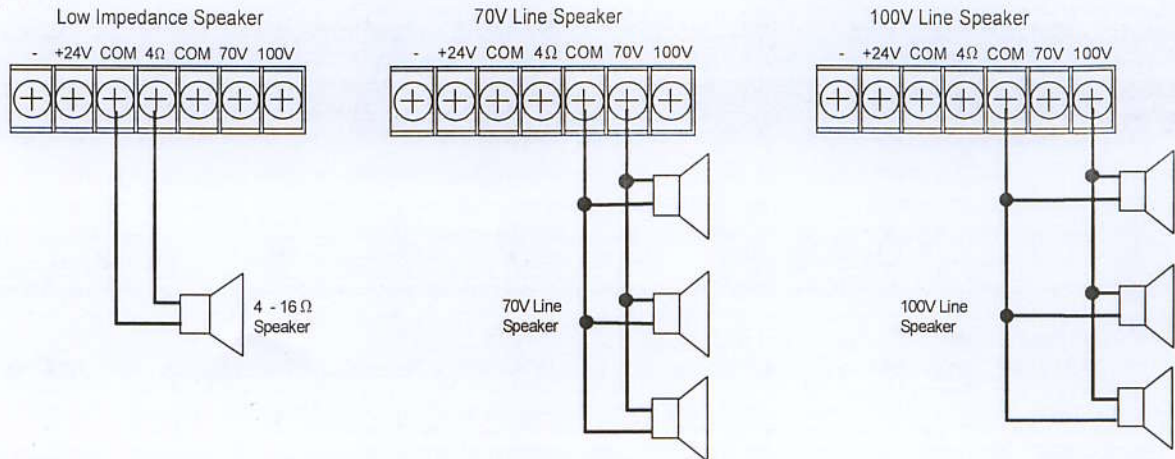

### CAUTION!

- Tripartite the 4Ω, 70V and 100V terminals cannot be used at the same time.
- Impedances indicated at the terminal represent the total speaker system (load) impedances.

Total impedances of 100V line:  
• 42Ω

Total impedances of 70V line:  
• 21Ω



### CAUTION

Be sure to attach the supplied terminal cover after connection completion. Because high voltage is applied to the speaker terminals, never touch these terminals to avoid electric shock.

## 6.3. Example of External Equipment Connections

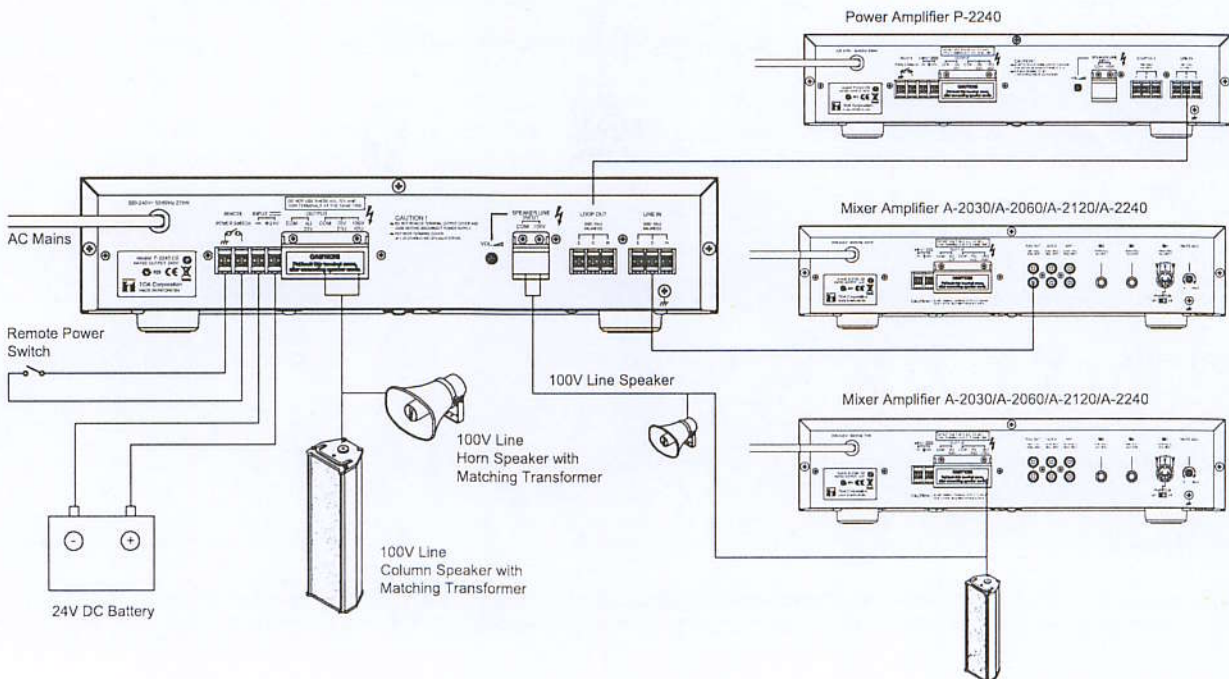



## 7. INSTALLATION

Keep the unit's all sides over 10 cm (3.94 inches) away from object that may obstruct air flow to prevent the unit's internal temperature rise.

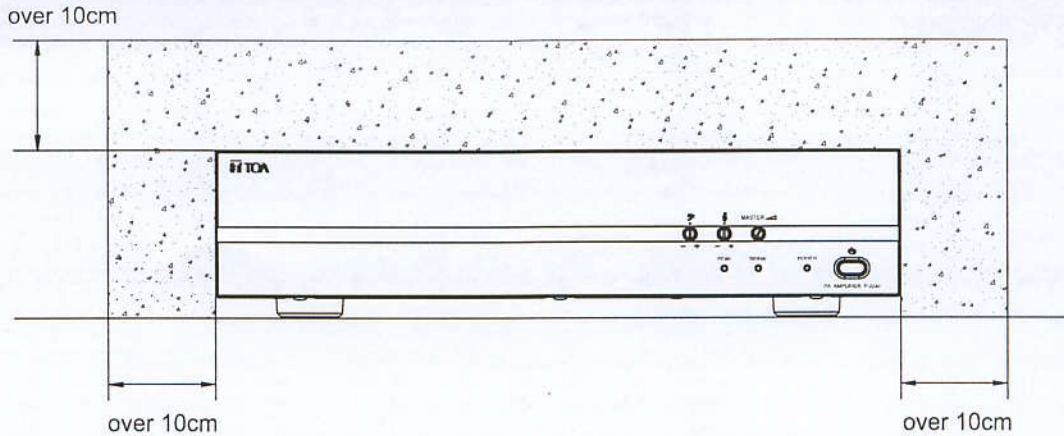

## 8. VOLUME CONTROL SETTINGS

Output levels are adjustable with individual volume controls. For music play or announcement, adjust the corresponding volume control so that the red peak indicator lights intermittently. Note that the sound quality is downgraded when the peak indicator remains lit.

## 9. BLOCK & LEVEL DIAGRAM

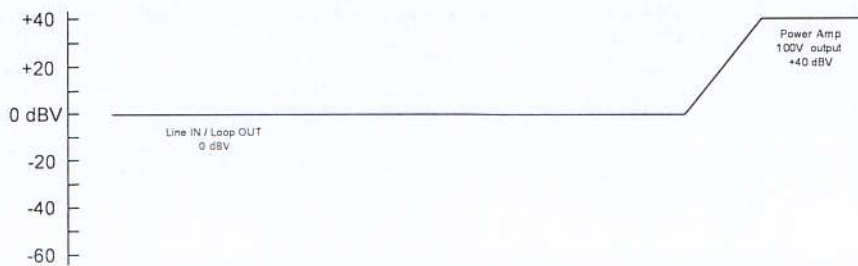
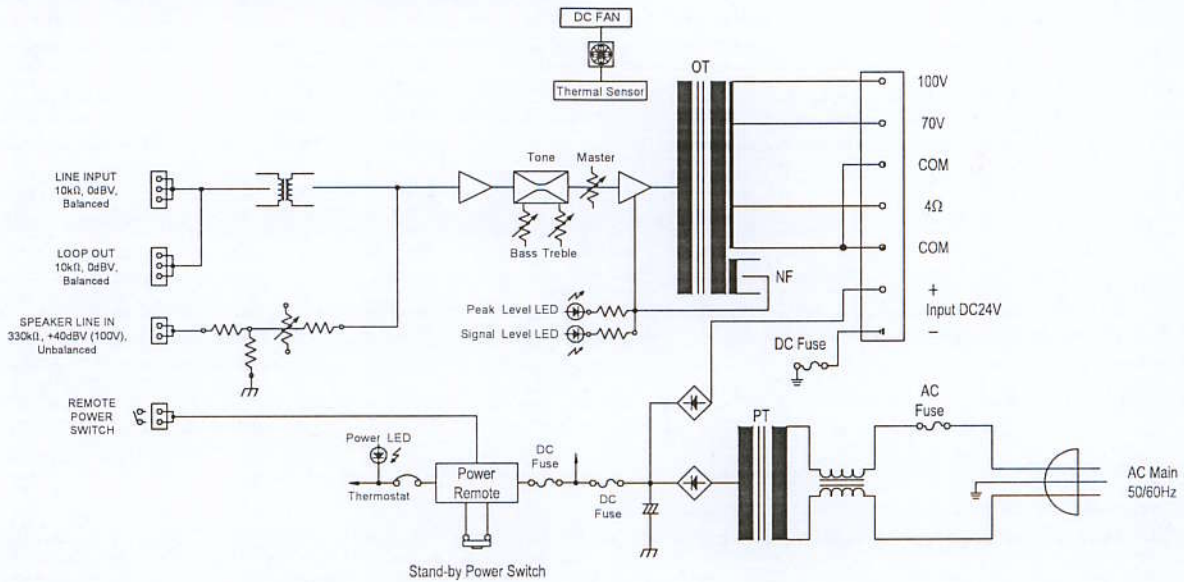

# 10. DIMENSIONAL DIAGRAM

units: mm(inches)

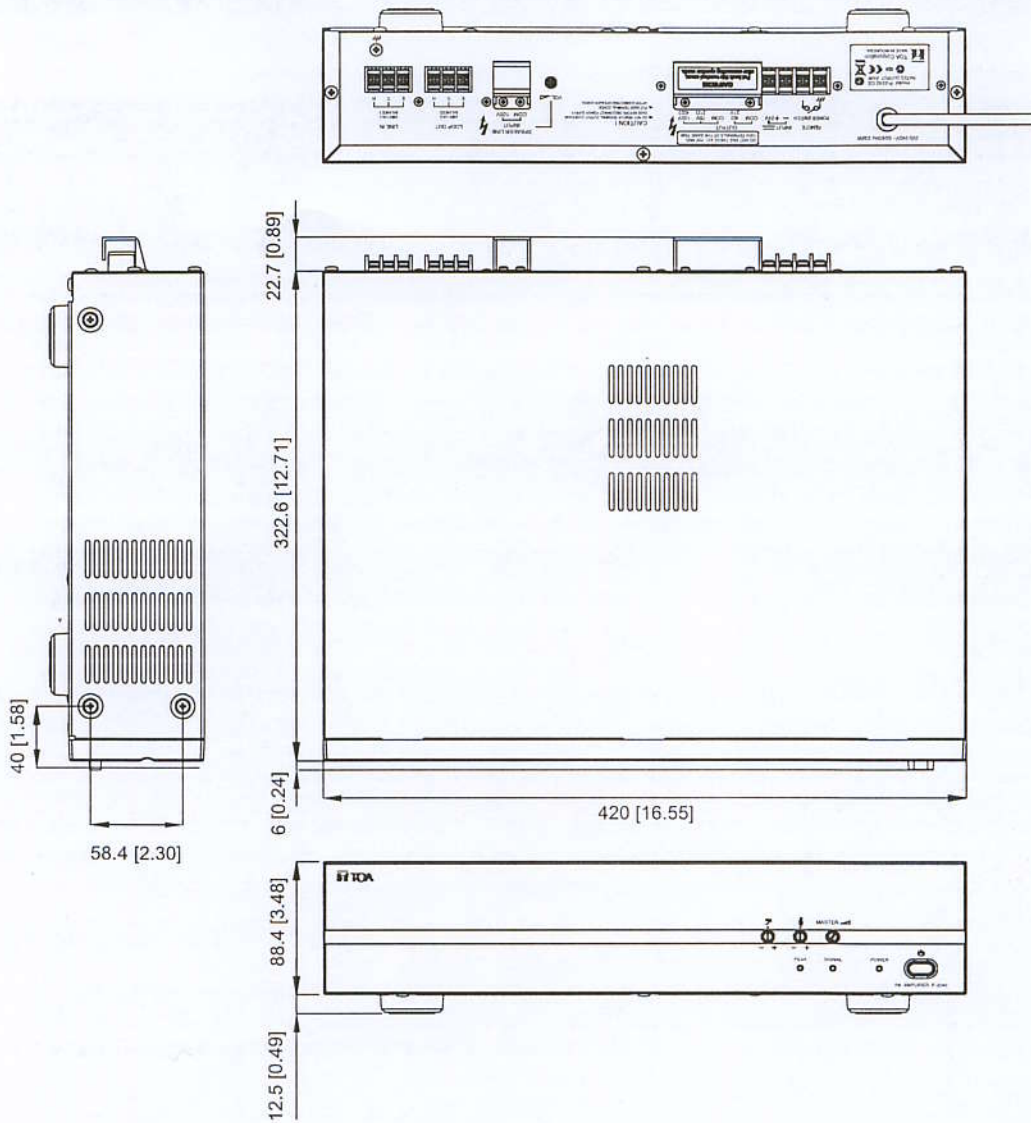

## 12. SPECIFICATIONS

|                                                                                                        |                  |                                                                                   |
|--------------------------------------------------------------------------------------------------------|------------------|-----------------------------------------------------------------------------------|
| Model No.                                                                                              |                  | P-2240 CE<br>P-2240 CE-GB<br>P-2240 CE-AU                                         |
| Power Source                                                                                           |                  | 220 - 240 V AC or 24 V DC                                                         |
| Rated Output                                                                                           |                  | 240 W                                                                             |
| Power Consumption<br>(IEC60065)                                                                        |                  | 238 W                                                                             |
| DC Current Consumption<br>(at rated output)                                                            |                  | 15 A                                                                              |
| Frequency Response                                                                                     |                  | 50 - 20,000 Hz, $\pm 3$ dB                                                        |
| Distortion                                                                                             |                  | Less Than 1% at 1kHz, 1/3 Rated Power                                             |
| Inputs                                                                                                 | Line In/Loop Out | 0 dBV (1V), 10 k $\Omega$ , Balanced, Screw Terminal                              |
|                                                                                                        | Speaker Line In  | 40 dBV (100 V), 330 k $\Omega$ , Unbalanced, Screw Terminal                       |
| Outputs                                                                                                | Speaker Out      | All Speaker Outputs are Floating Balanced                                         |
|                                                                                                        | 100V             | 42 $\Omega$                                                                       |
|                                                                                                        | 70 V             | 21 $\Omega$                                                                       |
|                                                                                                        | 4 $\Omega$       | 31 V                                                                              |
| S/N Ratio                                                                                              |                  | Over 60 dB                                                                        |
| Tone Controls                                                                                          |                  | Bass: $\pm 10$ dB at 100 Hz<br>Treble: $\pm 10$ dB at 10 kHz                      |
| Controls                                                                                               | Front Panel      | 1-Master VR, 1-Bass Tone VR, 1-Treble Tone VR (semi-fixed type)<br>1-Power Switch |
|                                                                                                        | Rear Panel       | 1-Speaker Line In VR (semi-fixed type),<br>1-Remote Power Control Terminal        |
| Indicators                                                                                             |                  | Power LED, Signal LED, Peak LED                                                   |
| Ventilation                                                                                            |                  | Fan Cooling                                                                       |
| Finish                                                                                                 |                  | Panel: ABS Resin, Black<br>Case: Steel Plate, Black                               |
| Dimensions                                                                                             |                  | 420(W) x 101(H) x 360(D) mm<br>16.54(W) x 3.98(H) x 11.02(D) inches               |
| Weight                                                                                                 |                  | 13.2 kg<br>29.10 lb                                                               |
| CE , CE-AU and CE-GB are the identically same specifications, but only power supply cord is different. |                  |                                                                                   |

\*) 0dBV = 1.0V

\*\*) Specifications are measured on 240V AC for all models.

**Note:** The design and specifications are subject to change without notice for improvement.

