

LB1-UW12-x Cabinet Loudspeakers

www.trungchinhaudio.vn

TCA
TRUNG CHINH AUDIO



BOSCH
Invented for life



- Good speech intelligibility and background music reproduction
- Available in black or white
- MDF construction
- Complies with international installation and safety regulations

The LB1-UW12-x is a 12 W, general-purpose, cost-effective loudspeaker for indoor use. Keyholes at the rear provide quick and easy wall mounting. The angled front baffle results in a better sound in the listening area. The cabinet is available in black or white.

higher customer satisfaction, longer operating life, and much less chance of failure or performance deterioration.

Safety

acc. to EN 60065

Functions

The robust, solid MDF (Medium Density Fiber board) enclosures are covered with a durable, easy-to-clean vinyl in a choice of white or black. The ABS fronts are covered with fine woven cloth in matching color.

The angled front baffle results in improved high frequency reproduction in the listening area.

Installation/configuration notes

Three keyholes in the rear panel provide easy and quick wall mounting. A convenient easy-to-use, 4-pole push-in terminal block is present on the rear panel for on-site wiring. This terminal block has provision for power tapping on the 100-volt, matching transformer in the cabinet. It allows selection of nominal full-power, half-power or quarter-power radiation (in 3 dB steps).

Certifications and approvals

All Bosch loudspeakers are designed to withstand operating at their rated power for 100 hours in accordance with IEC 268-5 Power Handling Capacity (PHC) standards. Bosch has also developed the Simulated Acoustical Feedback Exposure (SAFE) test to demonstrate that they can withstand two times their rated power for short durations. This ensures extra reliability under extreme conditions, leading to

2 | LB1-UW12-x Cabinet Loudspeakers

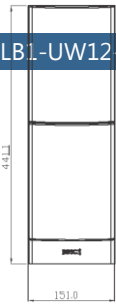

Dimensions in mm

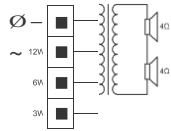

Circuit diagram

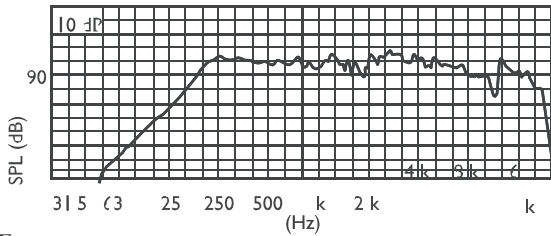

Frequency response

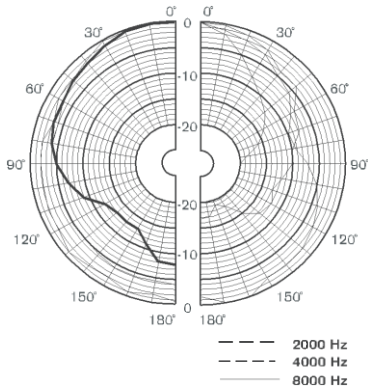

Polar diagram horizontal (measured with pink noise)

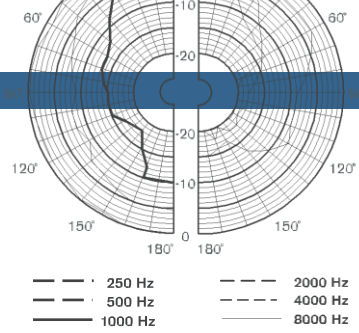
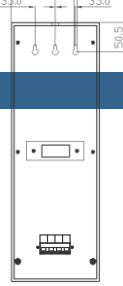
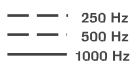

Polar diagram vertical (measured with pink noise)

Technical specifications

Electrical*

Maximum power	18 W
Rated power	12 / 6 / 3 W
Sound pressure level at 12 W / 1 W (1 kHz, 1 m)	104 / 93 dB (SPL)
Effective frequency range (-10 dB)	160 Hz to 20 kHz
Opening angle	1 kHz / 4 kHz (-6 dB)
horizontal	195° / 95°
vertical	69° / 17°
Rated input voltage	100 V
Rated impedance	833 ohm

* Connector: 4-pole push-in terminal block
 Technical performance data acc. to IEC 60268-5

Mechanical

Dimensions (H x W x D)	441 x 151 x 150/111 mm (17.4 x 5.9 x 5.9/4.4 in)
Weight	2.5 kg (5.5 lb)
Color	Black (D) or white (L)
cabinet / cloth (D)	Matches RAL 9004 / RAL 9004
cabinet / cloth (L)	Matches RAL 9010 / RAL 7044

Environmental

Operating temperature	-25 °C to +55 °C (-13 °F to +131 °F)
Storage temperature	-40 °C to +70 °C (-40 °F to +158 °F)
Relative humidity	<95%

Ordering information

LB1-UW12-D Cabinet Loudspeaker

12 W, black

Order number **LB1-UW12-D**

LB1-UW12-L Cabinet Loudspeaker

12 W, white

Order number **LB1-UW12-L**

Represented by:

Americas:

Bosch Security Systems, Inc.
12000 Portland Avenue South
Burnsville MN 55337, USA
Phone: +1-800-392-3497
Fax: +1-800-955-6831
audiosupport@us.bosch.com
www.boschsecurity.com

Europe, Middle East, Africa:

Bosch Security Systems B.V.
P.O. Box 80002
5617 BA Eindhoven, The Netherlands
Phone: +31 40 2577 284
Fax: +31 40 2577 330
emea.securitysystems@bosch.com
www.boschsecurity.com

Asia-Pacific:

Robert Bosch (SEA) Pte Ltd, Security Systems
11 Bishan Street 21
Singapore 573943
Phone: +65 6571 2808
Fax: +65 6571 2699
apr.securitysystems@bosch.com
www.boschsecurity.asia

China:

Bosch (Shanghai) Security Systems Ltd.
201 Building, No. 333 Fuquan Road
North IBP
Changning District, Shanghai
200335 China
Phone: +86 21 22181111
Fax: +86 21 22182398
www.boschsecurity.com.cn

America Latina:

Robert Bosch Ltda Security Systems Division
Via Anhanguera, Km 98
CEP 13065-900
Campinas, Sao Paulo, Brazil
Phone: +55 19 2103 2860
Fax: +55 19 2103 2862
al.securitysystems@bosch.com
www.boschsecurity.com