

Loudspeaker



S215V



C215V



S115V



C115V



S112V



C112V

Durable carpeted exteriors and stunning sound for the rigors of the road.

A sophisticated spray-finish look with the legendary Club V sound.

- Painstaking selection of parts and components, optimized wooden enclosures, and a thorough reevaluation of speaker capacity take sonic performance to a new level.
- Dual phone jacks and dual Speakon connectors for input and parallel connection
- Protection circuit prevents excessive tweeter input due to acoustic feedback or other causes.
- Durable enclosure with arced steel grille, and large metal handles for improved portability
- S112V (C112V) and S115V (C115V) are equipped with a pole socket for use with speaker stands.
- The YSProcessing (Yamaha Speaker Processing) switch provided on the EMX series powered mixers and P series amplifiers enhances matching with single-woofer models for even greater sonic impact.

Concert Club V Series

GENERAL SPECIFICATIONS

Model	S215V / C215V	S115V / C115V	S112V / C112V
Type	2-way bass-reflex		
Frequency range (-10dB)	42Hz-16kHz	55Hz-16kHz	60Hz-16kHz
Nominal coverage (Horizontal x Vertical)	90° x 40°		
Nominal impedance	4Ω	8Ω	
Power rating	NOISE	500W	175W
	PGM	1000W	350W
	MAX	2000W	700W
Sensitivity (1W,1m)	99dB SPL		97dB SPL
Component	LF	15" cone x 2	15" cone
	HF	CD horn + 2" voice coil compression driver	
Connectors	1/4" phone jack x 2, SPEAKON Neutrik NL4MP x 2		
Dimensions (W x H x D)	495 x 1167 x 597mm (19.5" x 46.0" x 23.5")	489 x 719 x 377mm (19.3" x 28.3" x 14.8")	420 x 632 x 333mm (16.5" x 24.9" x 13.1")
Weight	S215V: 47.2kg (104.1lbs) / C215V: 47.5kg (104.7lbs)	S115V: 29.4kg (64.8lbs) / C115V: 30.3kg (66.8lbs)	S112V: 20.8kg (45.9lbs) / C112V: 21.3kg (47lbs)

DIMENSIONS

unit : mm (inch)

S215V/C215V

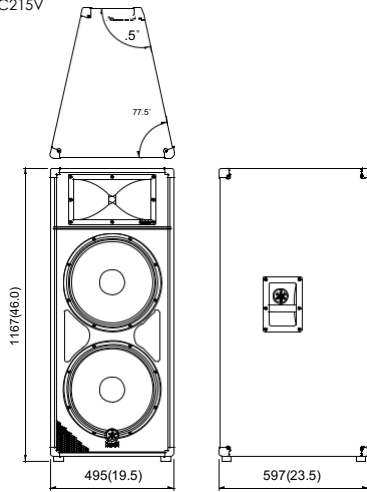

S115V/C115V

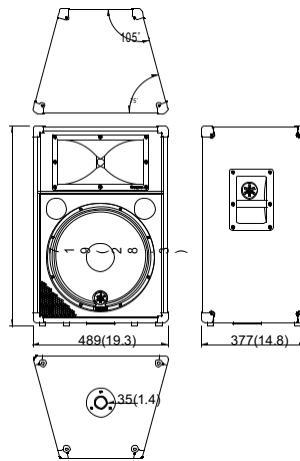

S112V/C112V

